



▶ PSSu K S RS232

PILZ

THE SPIRIT OF SAFETY

Operating Manual-1002589-EN-04

- Decentralised system PSSuniversal I/O



This document is the original document.

Where unavoidable, for reasons of readability, the masculine form has been selected when formulating this document. We do assure you that all persons are regarded without discrimination and on an equal basis.

All rights to this documentation are reserved by Pilz GmbH & Co. KG. Copies may be made for the user's internal purposes. Suggestions and comments for improving this documentation will be gratefully received.

Pilz®, PIT®, PMI®, PNOZ®, Primo®, PSEN®, PSS®, PVIS®, SafetyBUS p®, SafetyEYE®, SafetyNET p®, the spirit of safety® are registered and protected trademarks of Pilz GmbH & Co. KG in some countries.



SD means Secure Digital

1	Introduction	4
1.1	Validity of documentation	4
1.1.1	Retaining the documentation	4
1.1.2	Terminology: System environment A and B	4
1.2	Definition of symbols	5
2	Overview	6
2.1	Module structure	6
2.2	Module features	6
2.3	Front view	7
3	Safety	8
3.1	Intended use	8
3.2	Safety regulations	9
3.2.1	Use of qualified personnel	9
3.2.2	Warranty and liability	9
3.2.3	Disposal	9
4	Function description	10
4.1	Module features	10
4.1.1	Function description	10
4.1.2	Integrated protection mechanisms	10
4.2	Configuration	11
4.2.1	Interface parameters	11
4.2.2	Receive buffer threshold	11
5	Installation	12
5.1	General installation guidelines	12
5.1.1	Dimensions	12
5.2	Install compact module	13
6	Wiring	15
6.1	Interface configuration	15
6.1.1	RS232 interface	15
7	Operation	16
7.1	Messages	16
7.2	Display elements	16
7.2.1	Display element for operational readiness	16
7.2.2	Display element for module error	17
7.2.3	Display elements for data transmission	17
8	Technical details	18
9	Order reference	20
9.1	Product	20
9.2	Accessories	20

1 Introduction

1.1 Validity of documentation

This documentation is valid for the product PSSu K S RS232. It is valid until new documentation is published.

This operating manual explains the function and operation, describes the installation and provides guidelines on how to connect the product.

1.1.1 Retaining the documentation

This documentation is intended for instruction and should be retained for future reference.

1.1.2 Terminology: System environment A and B

The PSSu system can be used in two different system environments. The module's application area is described in the chapter "Intended Use" of the manual.

The distinction is made between

- ▶ PSSu in system environment A
- ▶ PSSu in system environment B

The distinction is based on the application area of the PSSu system.

PSSu in system environment A may be used in the

- ▶ Decentralised system PSSu I/O
- ▶ **Not** in the automation system PSS 4000

PSSu in system environment B may be used in the

- ▶ Automation system PSS 4000, e.g. with
 - Decentralised system PSSu I/O with SafetyNET p
 - Control system PSSu PLC
 - Control system PSSu multi

The module PSSu K S RS232 is exclusively for use in system environment B (automation system PSS 4000).

1.2 Definition of symbols

Information that is particularly important is identified as follows:



DANGER!

This warning must be heeded! It warns of a hazardous situation that poses an immediate threat of serious injury and death and indicates preventive measures that can be taken.



WARNING!

This warning must be heeded! It warns of a hazardous situation that could lead to serious injury and death and indicates preventive measures that can be taken.



CAUTION!

This refers to a hazard that can lead to a less serious or minor injury plus material damage, and also provides information on preventive measures that can be taken.



NOTICE

This describes a situation in which the product or devices could be damaged and also provides information on preventive measures that can be taken. It also highlights areas within the text that are of particular importance.



INFORMATION

This gives advice on applications and provides information on special features.

2 Overview

2.1 Module structure

The module combines the function unit (inputs or outputs, interfaces) and connection levels in one housing.

Wiring is via Sub-D female and male connectors

2.2 Module features

The product has the following features:

- ▶ Serial interface: RS 232
- ▶ Communication channels: 2 (Tx/Rx, full duplex)
- ▶ Configurable transmission rates
- ▶ Receive buffer: 1023 Byte
- ▶ Send buffer: 127 Byte
- ▶ Max. number per system: 6
- ▶ LEDs for:
 - Operational readiness
 - Module error
 - Data transmission
- ▶ For standard applications in system environment B (automation system PSS 4000)

2.3 Front view

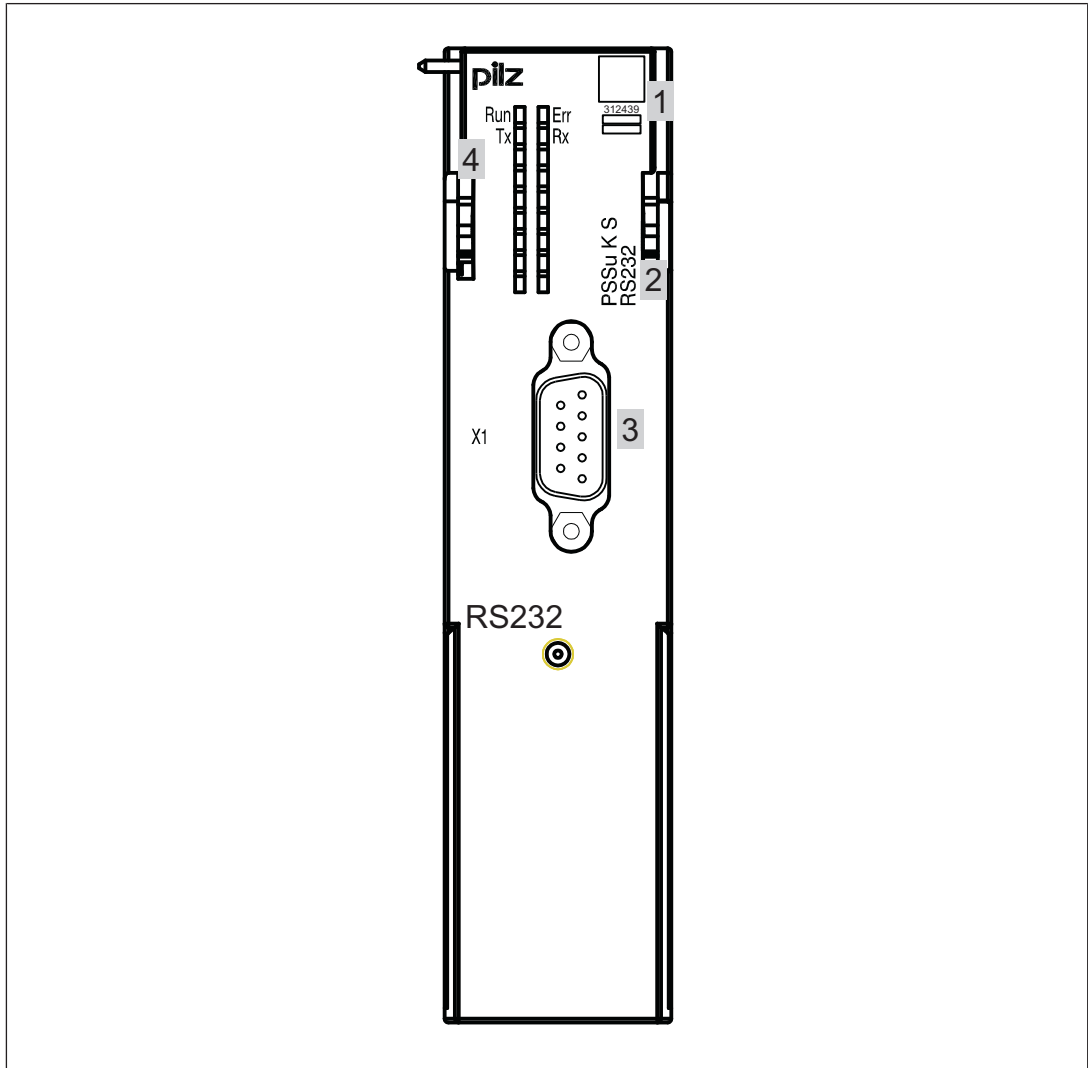

Key:

- ▶ 1: Labelling strip with:
 - 2D code
 - Order Number
 - Serial Number
 - Hardware version number
- ▶ 2: Name of compact module
- ▶ 3: D-Sub connector (male) X1
- ▶ 4: LEDs for status display and module diagnostics

3 Safety

3.1 Intended use

Use in a PSSu system

The module may be used in a PSSu system in system environment B.

The head module establishes in what system environment a PSSu system can be used.

▶ System environment B

A PSSu system in system environment B is a PSSu system in the automation system PSS 4000. The PSSu system can belong to one of the following performance classes:

- Decentralised system PSSu I/O (with SafetyNET p)
- Control system PSSu PLC
- Control system PSSu multi

Standard applications

The module may be used for standard applications.

Module's function

The module provides a serial interface. It is designed for communication in non-safety-related applications.

Particular application areas

▶ Lift applications

The module PSSu K S RS232 can be used in conjunction with PESSRAL modules (programmable electronic system in safety-related applications for lifts) in accordance with the Lifts Directive 2014/33/EU. The modules meet the requirements in accordance with EN 81-20, EN 81-22, EN 81-50 for passenger and goods lifts, as well as the requirements in accordance with EN 115-1 for escalators and moving walks.

The module/the safety controller should be installed in a protected environment. Example: Protected inside space or control cabinet with protection class and corresponding air conditioning specified in [Technical details](#) [ 18].

EMC-compliant installation

Intended use includes making the electrical installation EMC-compliant. Please refer to the guidelines stated in the "PSSuniversal Installation Manual". The module is intended for use in an industrial environment. Interference may occur if used within a domestic environment.

Improper use

The following is deemed improper use in particular

- ▶ Any component, technical or electrical modification to the module,
- ▶ Use of the module outside the areas described in this operating manual,
- ▶ Any use of the module that is not in accordance with the technical details.

Software tools

The module is supported by PAS4000 from Version 1.0.0.



INFORMATION

We recommend that you always use the latest version of the software tool (download from www.pilz.com).

3.2 Safety regulations

3.2.1 Use of qualified personnel

The products may only be assembled, installed, programmed, commissioned, operated, maintained and decommissioned by persons who are competent to do so.

A competent person is a qualified and knowledgeable person who, because of their training, experience and current professional activity, has the specialist knowledge required. In order to inspect, assess and handle products, devices, systems, plant and machinery, this person must be familiar with the state of the art and the applicable national, European and international laws, directives and standards.

It is the company's responsibility only to employ personnel who

- ▶ Are familiar with the basic regulations concerning health and safety / accident prevention,
- ▶ Have read and understood the information provided in the section entitled Safety
- ▶ Have a good knowledge of the generic and specialist standards applicable to the specific application.

3.2.2 Warranty and liability

All claims to warranty and liability will be rendered invalid if

- ▶ The product was used contrary to the purpose for which it is intended,
- ▶ Damage can be attributed to not having followed the guidelines in the manual,
- ▶ Operating personnel are not suitably qualified,
- ▶ Any type of modification has been made (e.g. exchanging components on the PCB boards, soldering work etc.).

3.2.3 Disposal

- ▶ In safety-related applications, please comply with the mission time T_M in the safety-related characteristic data.
- ▶ When decommissioning, please comply with local regulations regarding the disposal of electronic devices (e.g. Electrical and Electronic Equipment Act).

4 Function description

4.1 Module features

4.1.1 Function description

The module enables communication via a serial interface.

Module supply

- ▶ The module supply provides the module with voltage.

Periphery supply

- ▶ The periphery supply provides the serial interface with voltage.

Signal processing

- ▶ In each cycle, a max. of 8 Bytes of data can be transferred in both directions between control system and module. The data to be transferred is stored temporarily in a send and receive buffer.
- ▶ Two additional status bytes and control bytes are available in the process image for data exchange between control system and module.
- ▶ All the configuration data is stored in the head module and is assigned to the module on restart. This way the configuration data is retained even if you change the module.

Schematic representation of signal processing with the PSSu PLC/PSSu multi control system:

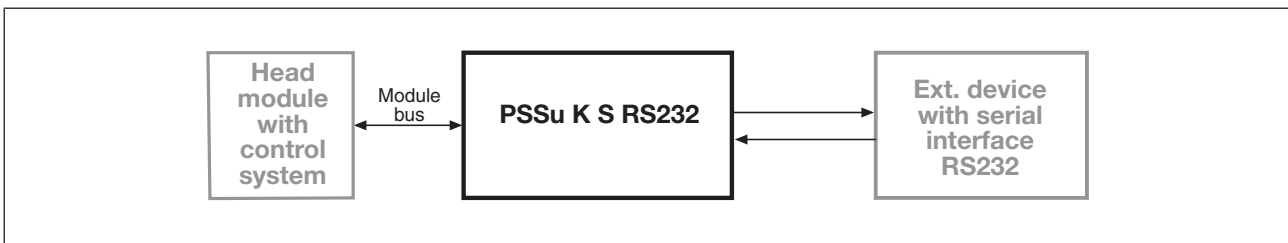

4.1.2 Integrated protection mechanisms

When the PSSu E F PS1(-T) or PSSu E F PS2(-T)(-R) is used to supply the system, the module supply is buffered for 20 ms if the supply voltage is interrupted.

The module detects the following errors:

- ▶ Start-up error
- ▶ Configuration error
- ▶ ST communication error
- ▶ Bus termination error

4.2 Configuration

The module has the following configuration options:

- ▶ Interface parameter
- ▶ Threshold receive buffer

4.2.1 Interface parameters

The following interface parameters can be configured:

- ▶ Transmission rate
- ▶ Block size (data bits and parity)
- ▶ Number of stop bits
- ▶ Continuous sending
- ▶ Xon/Xoff when sending
- ▶ Xon/Xoff when receiving
- ▶ RTS and CTS activated

4.2.2 Receive buffer threshold

The number of Bytes in a receive buffer of the module is defined with this value, from which the status bit "Receive buffer full" is set (default value: 512).

5 Installation

5.1 General installation guidelines

Please refer also to the PSSuniversal Installation Manual.



NOTICE

Damage due to electrostatic discharge!

Electrostatic discharge can damage components. Ensure against discharge before touching the product, e.g. by touching an earthed, conductive surface or by wearing an earthed armband.

5.1.1 Dimensions

Schematic representation:

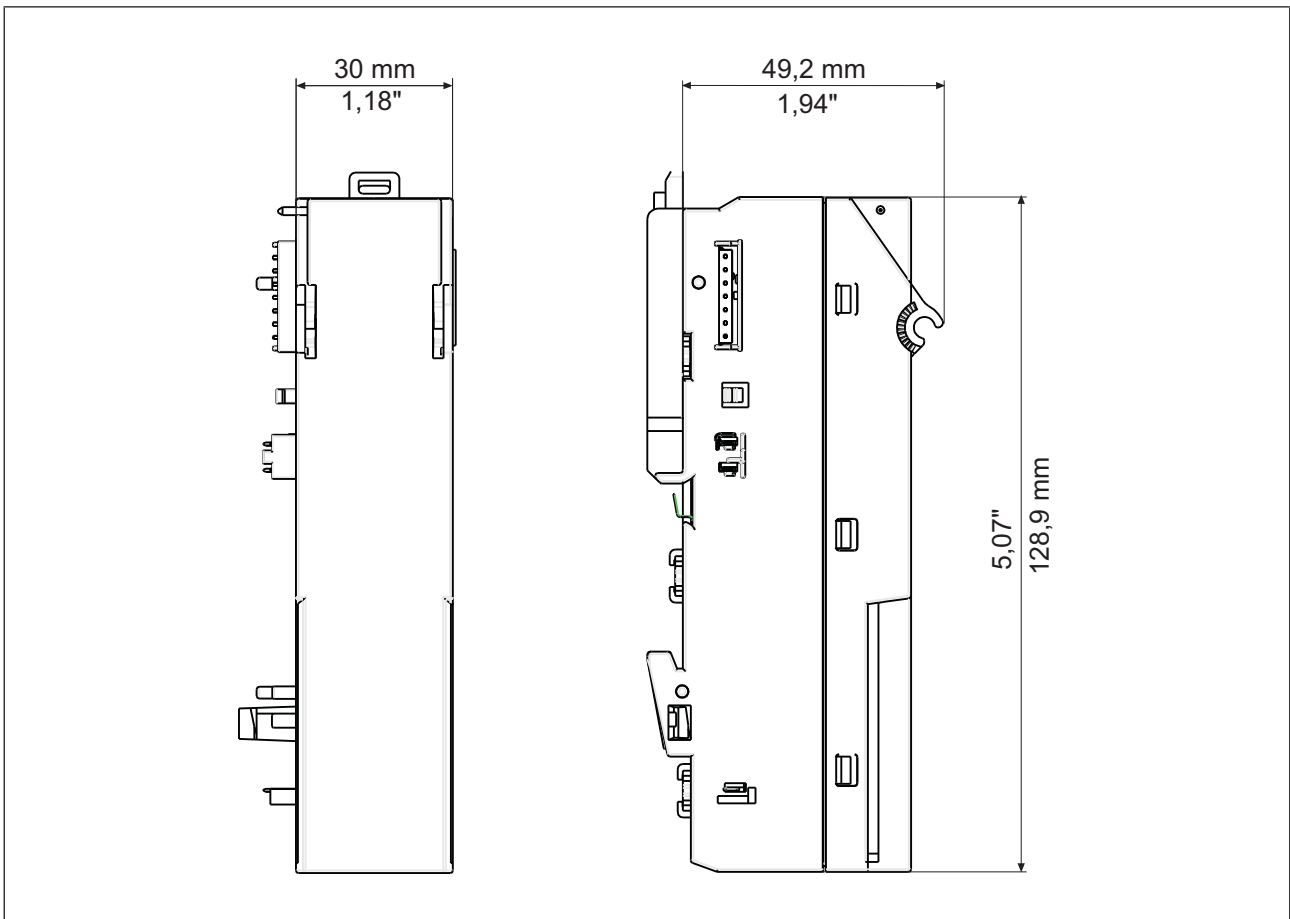

5.2 Install compact module

Prerequisite:

- ▶ The head module must be installed.
- ▶ If the head module does not have an integrated power supply, a supply voltage module must be installed to the right of the head module.
- ▶ A base module with screw terminals may not be installed to the left of the compact module.

Please note:

- ▶ All contacts should be protected from contamination.
- ▶ The mechanics of the compact modules are designed for 50 plug in/out cycles.

Procedure:

- ▶ Slot the groove on the compact module on to the mounting rail from below [1].
- ▶ Push the compact module back as far as it will go [2].
- ▶ Make sure that the locking mechanism [3] is pushed downwards, connecting the module firmly to the mounting rail.
- ▶ On the mounting rail, slide the compact module to the left.



NOTICE

Potential contact damage due to twisting!

The contacts for the Module Supply and Periphery Supply can be bent by twisting the compact modules on the mounting rail.

- On the mounting rail, carefully slide the compact module to the left, in parallel to the adjoining module, until you hear the lateral mounting hooks on the adjacent module lock into position [4].

Schematic representation:

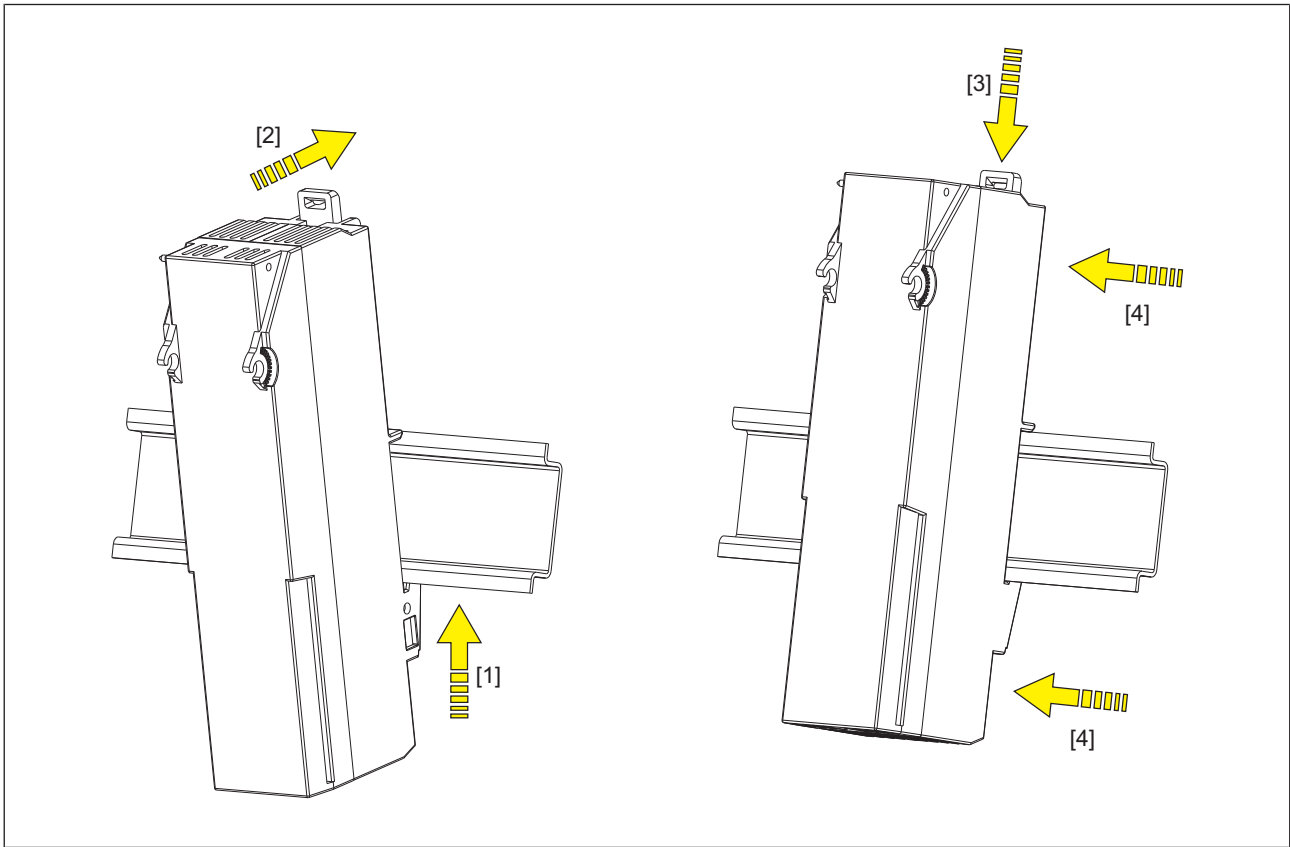

6 Wiring

6.1 Interface configuration

6.1.1 RS232 interface

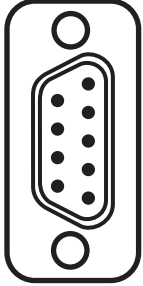
RS232	Assignment	X1
D-Sub male connector	1: n.c. 2: Input Rx (receive data) 3: Output Tx (send data) 4: n.c. 5: GND 6: n.c. 7: Output RTS 8: Input CTS 9: n.c.	 <p>The diagram shows a D-Sub male connector with 9 pins. Pin 1 is at the top right, pin 5 is at the bottom right, pin 6 is at the top left, and pin 9 is at the bottom left. The connector has a shielded shell and two mounting holes at the top and bottom.</p>

n.c. = not connected

7 Operation

7.1 Messages

A module error is displayed via the "Err" LED, signalled to the head module and then entered in the head module's diagnostic log.

The module can detect the following errors:

Errors	Statement	Remedy
Start-up error	Error as the PSSu system starts up	Change faulty module.
Configuration error	Wrong module type selected or invalid module configuration	Adjust the configured hardware registry to the actual hardware registry so that they match, or correct the module configuration.
ST communication error	Error during ST communication	Change faulty module
Bus termination error	There is no terminating plate or there is a bad contact with the module bus.	Install a terminating plate with integrated end bracket or insert the base modules together correctly.



7.2 Display elements

Legend

-  LED on
-  LED off

7.2.1 Display element for operational readiness

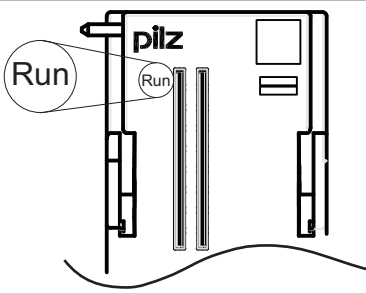
The module has an LED for displaying that the system is ready for operation (LED "Run").

	LED			Key
	Description	Colour	Status	
	Run	---		Module not ready for operation
	green		Module ready for operation	

7.2.2 Display element for module error

The module has an LED for displaying module errors ("Err" LED).

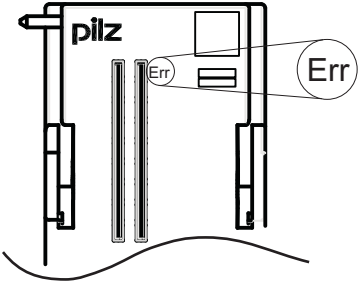
	LED			Meaning
	Designation	Colour	Status	
	Err	---	●	No error
	Red	☀	Module is faulty	

7.2.3 Display elements for data transmission

The module has the LEDs Tx and Rx for displaying the data transfer (LEDs "Tx" and "Rx").

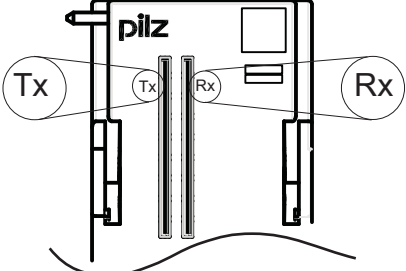
	LED			Key	
	Description	Colour	Status	Signal	Pin
	Tx	---	●	No data transfer	2
		green	☀	Send data	
	Rx	---	●	No data transfer	3
		green	☀	Receive data	

8 Technical details

General	
Certifications	CE, TÜV, UKCA, cULus Listed
Application range	Standard
Module's device code	0720h
Number of ST input bits	64
Number of ST output bits	64
Number of ST status bits	16
Number of ST control bits	16
Application in system environment B from ST firmware version, head modules	1.0.0
Electrical data	
Internal supply voltage (module supply) Module's power consumption	0,63 W
Periphery's supply voltage (periphery supply) Voltage range	16,8 - 30 V
Module's current consumption with no load	20 mA
Module's power consumption with no load	0,48 W
Max. power dissipation of module	1,2 W
Serial interface	
Number of RS232 interfaces	1
Transmission rate (configurable)	1,2 kBit/s, 19,2 kBit/s, 2,4 kBit/s, 300 Bit/s, 4,8 kBit/s, 600 Bit/s, 9,6 kBit/s
Max. cable length	15 m
Size of receive buffer	1.023 Byte
Size of send buffer	127 Byte
Potential isolation between interface and module supply	Yes
Potential isolation between interface and periphery supply	Yes
Environmental data	
Climatic suitability	EN 60068-2-1, EN 60068-2-14, EN 60068-2-2, EN 60068-2-30, EN 60068-2-78
Ambient temperature in accordance with the standard Temperature range	EN 60068-2-14 0 - 60 °C
Storage temperature in accordance with the standard Temperature range	EN 60068-2-1/-2 -25 - 70 °C
Climatic suitability in accordance with the standard Humidity	EN 60068-2-30, EN 60068-2-78 93 % r. h. at 40 °C
Condensation during operation	Not permitted
Max. operating height above SL	2000 m

Environmental data	
EMC	EN 61000-4-2, EN 61000-4-3, EN 61000-4-4, EN 61000-4-5, EN 61000-4-6, EN 61131-2
Vibration	
in accordance with the standard	EN 60068-2-6
Frequency	10 - 150 Hz
Acceleration	1g
Shock stress	
in accordance with the standard	EN 60068-2-27
Number of shocks	6
Acceleration	15g
Duration	11 ms
in accordance with the standard	EN 60068-2-27
Number of shocks	1000
Acceleration	10g
Duration	16 ms
Airgap creepage	
in accordance with the standard	EN 61131-2, IEC 60664-1
Overvoltage category	II
Pollution degree	2
Protection type	
in accordance with the standard	EN 60529
Housing	IP20
Mounting area (e.g. control cabinet)	IP54
Mechanical data	
Mounting position	horizontally on mounting rail
Material	
Bottom	PC
Front	PC
Connection type	D-Sub male connector
Dimensions	
Height	128,9 mm
Width	30 mm
Depth	56 mm
Weight	81 g

Where standards are undated, the 2009-03 latest editions shall apply.

9 Order reference

9.1 Product

Product type	Features	Order no.
PSSu K S RS232	Compact module without connector, labelling bracket and labelling strips, base type	312439

9.2 Accessories

Terminals

Product type	Features	Order no.
PSSu A Con 1/10 C	Connector with spring-loaded terminals 1-row/10-pin, scope of supply: 2 pieces	313115
PSSu A Con 3/30 C	Connector with spring-loaded terminals 3-row/30-pin, scope of supply: 2 pieces	313116

Labelling

Product type	Features	Order no.
PSSu A LC 0.1	Labelling bracket, scope of delivery: 5 pieces	312966
PSSu A LA0	Labelling strips, laser printable, scope of delivery: 1080 pieces (10 x DIN A4 sheet, 108 on each)	312958

► Support

Technical support is available from Pilz round the clock.

Americas

Brazil

+55 11 97569-2804

Canada

+1 888 315 7459

Mexico

+52 55 5572 1300

USA (toll-free)

+1 877-PILZUSA (745-9872)

Asia

China

+86 400-088-3566

Japan

+81 45 471-2281

South Korea

+82 31 778 3300

Australia and Oceania

Australia

+61 3 95600621

New Zealand

+64 9 6345350

Europe

Austria

+43 1 7986263-444

Belgium, Luxembourg

+32 9 3217570

France

+33 3 88104003

Germany

+49 711 3409-444

Ireland

+353 21 4804983

Italy, Malta

+39 0362 1826711

Scandinavia

+45 74436332

Spain

+34 938497433

Switzerland

+41 62 88979-32

The Netherlands

+31 347 320477

Türkiye

+90 216 5775552

United Kingdom

+44 1536 462203

You can reach our international hotline on:

+49 711 3409-222

support@pilz.com

Pilz develops environmentally-friendly products using ecological materials and energy-saving technologies. Offices and production facilities are ecologically designed, environmentally-aware and energy-saving. So Pilz offers sustainability, plus the security of using energy-efficient products and environmentally-friendly solutions.



CECE[®], CHRE[®], CMSE[®], INDUSTRIAL P[®], Leansafe[®], Myzel[®], PAS4000[®], PASscal[®], PASconfig[®], Pilz[®], PIT[®], PMSprimo[®], PMSprotego[®], PMCiendo[®], PMD[®], PME[®], PNOZ[®], Primo[®], PSEN[®], PSEN[®], PSS[®], PVIS[®], SafetyBUS p[®], SafetyNET p[®], THE SPIRIT OF SAFETY[®] are registered and protected trademarks of Pilz GmbH & Co. KG in some countries. We would point out that product features may vary from the details stated in this document, depending on the status at the time of publication and the scope of the equipment. We accept no responsibility for the validity, accuracy and entirety of the text and graphics presented in this information. Please contact our Technical Support if you have any questions.

1002589-EN-04, 2024-10 Printed in Germany
© Pilz GmbH & Co. KG, 2019

We are represented internationally. Please refer to our homepage www.pilz.com for further details or contact our headquarters.

Headquarters: Pilz GmbH & Co. KG, Felix-Wankel-Straße 2, 73760 Ostfildern, Germany
Telephone: +49 711 3409-0, E-Mail: info@pilz.com, Internet: www.pilz.com

PILZ
THE SPIRIT OF SAFETY