



▶ PSSu H FS2 SN SD(-T)

PILZ

THE SPIRIT OF SAFETY

Operating Manual-1005194-EN-09

- Decentralised system PSSuniversal I/O



This document is the original document.

Where unavoidable, for reasons of readability, the masculine form has been selected when formulating this document. We do assure you that all persons are regarded without discrimination and on an equal basis.

All rights to this documentation are reserved by Pilz GmbH & Co. KG. Copies may be made for the user's internal purposes. Suggestions and comments for improving this documentation will be gratefully received.

Pilz®, PIT®, PMI®, PNOZ®, Primo®, PSEN®, PSS®, PVIS®, SafetyBUS p®, SafetyEYE®, SafetyNET p®, the spirit of safety® are registered and protected trademarks of Pilz GmbH & Co. KG in some countries.



SD means Secure Digital

1	Introduction	5
1.1	Validity of documentation	5
1.1.1	Retaining the documentation	5
1.2	Definition of symbols	5
1.3	Third-party manufacturer licence information	6
2	Overview	7
2.1	Module features	7
2.2	Front view	8
3	Safety	9
3.1	Intended use	9
3.2	Safety regulations	10
3.2.1	Use of qualified personnel	10
3.2.2	Warranty and liability	10
3.2.3	Disposal	10
4	Function description	11
4.1	Block diagram	11
4.2	Supply voltage	11
4.2.1	Function description	11
4.2.2	Current load capacity	12
4.3	Integrated protection mechanisms	14
4.4	SafetyNET p	14
4.4.1	Connection to SafetyNET p	14
4.5	Decentralised inputs and outputs	15
4.6	SD card	15
4.7	Reset button	16
5	Installation	17
5.1	General installation guidelines	17
5.2	Dimensions	17
5.3	Installing the head module	18
6	Interface assignment	19
7	Wiring	20
7.1	General wiring guidelines	20
7.2	Terminal configuration	21
7.3	Connecting the module	21
8	Operation	23
8.1	Messages	23
8.2	Display elements	23
8.2.1	MBUS	24
8.2.2	SD CARD	25
8.2.3	DIAG	26
8.2.4	ST SNp	27

8.2.5	FS SNp.....	28
8.2.6	5V, 24V.....	29
8.2.7	X3: LNK, X3: TRF, X4: LNK, X4: TRF.....	30
9	Technical details	31
9.1	Safety characteristic data.....	35
10	Supplementary data	36
10.1	Permitted operating height.....	36
11	Order reference	37
11.1	Product.....	37
11.2	Accessories.....	37
12	EC declaration of conformity	38
13	UKCA-Declaration of Conformity	39

1 Introduction

1.1 Validity of documentation

This operating manual explains the function and operation, describes the installation and provides guidelines on how to connect the product.

The documentation is valid for the product types:

- ▶ PSSu H FS2 SN SD from Version HW 2.0, FW 1.26.0
- ▶ PSSu H FS2 SN SD-T from Version HW 2.0, FW 1.26.0

It is valid until new documentation is published.

Please also refer to the following documents:

- ▶ System Description PSS 4000
- ▶ Installation Manual PSSuniversal

1.1.1 Retaining the documentation

This documentation is intended for instruction and should be retained for future reference.

1.2 Definition of symbols

Information that is particularly important is identified as follows:



DANGER!

This warning must be heeded! It warns of a hazardous situation that poses an immediate threat of serious injury and death and indicates preventive measures that can be taken.



WARNING!

This warning must be heeded! It warns of a hazardous situation that could lead to serious injury and death and indicates preventive measures that can be taken.



CAUTION!

This refers to a hazard that can lead to a less serious or minor injury plus material damage, and also provides information on preventive measures that can be taken.



NOTICE

This describes a situation in which the product or devices could be damaged and also provides information on preventive measures that can be taken. It also highlights areas within the text that are of particular importance.



INFORMATION

This gives advice on applications and provides information on special features.

1.3

Third-party manufacturer licence information

This product includes Open Source software with various licenses.

Further information is available in the document „Third-party manufacturer licence information PSS 4000-exclusive devices“ (document number 1003883) at www.pilz.com.

2 Overview

2.1 Module features

The head module belongs to the performance class "Decentralised system PSSu I/O". It can be used to connect a PSSu system to SafetyNET p. The head module has the following features:

- ▶ 2 free switch ports for connection to SafetyNET p
- ▶ Standard module bus for standard I/O modules
- ▶ Safety module bus for safety I/O modules
- ▶ SD card used to store the device project and the naming data
- ▶ Reset pushbutton
 - For warm reset
 - To transfer the naming data and/or device project from the SD card to the device memory
- ▶ Supply voltage
 - Integrated supply voltage for periphery supply and module supply
 - Module supply is buffered for 20 ms if the supply voltage is interrupted
 - Plug-in connection terminals (either spring-loaded terminal or screw terminal)
- ▶ Status LEDs
- ▶ T-type:
PSSu H FS2 SN SD-T: For increased environmental requirements

2.2 Front view

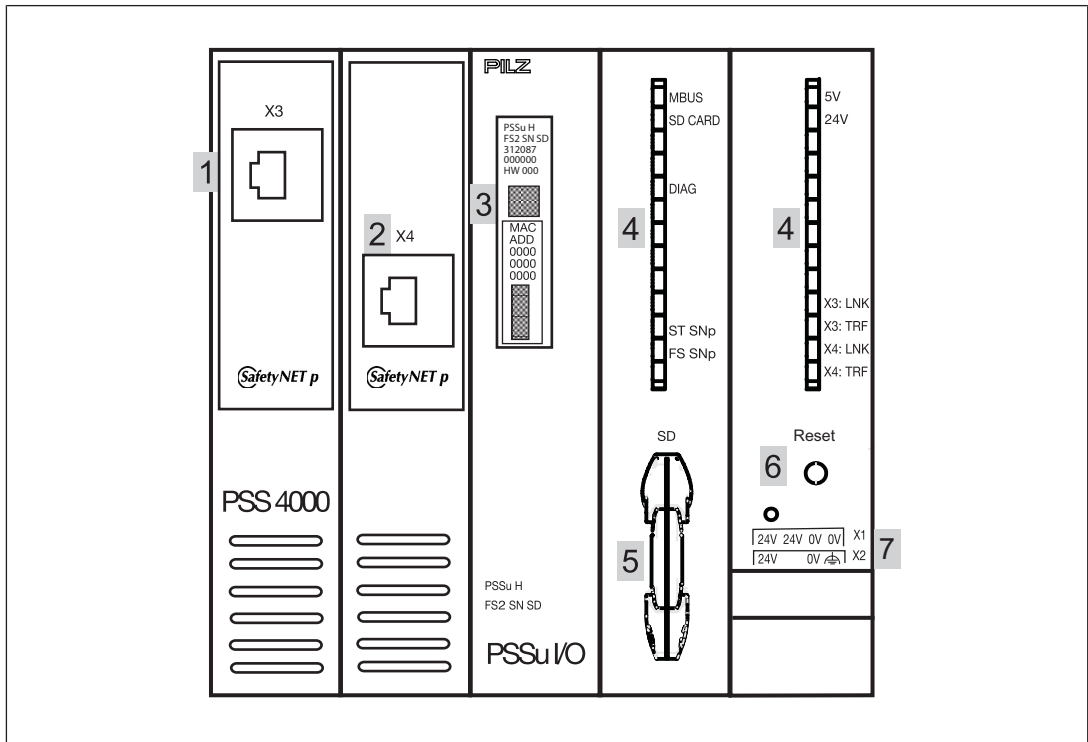

The labelling strip contains the following information:

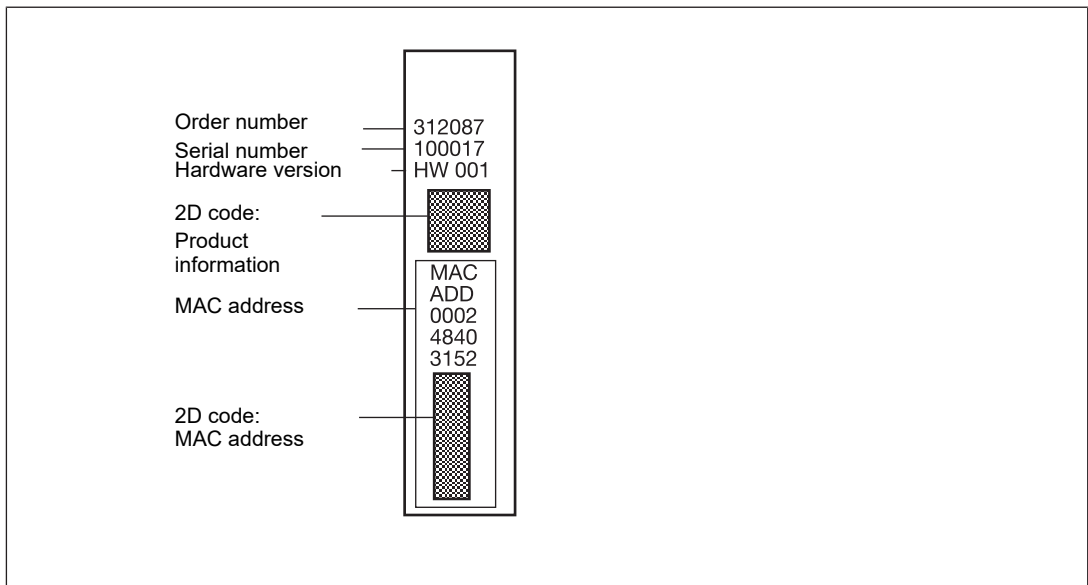

3 Safety

3.1 Intended use



INFORMATION

If the module name is not explicitly named, the details apply to all the variants of the module.

Fail-safe and standard applications

The module is suitable for use in safety and non-safety-related applications with **SafetyNET p**.

Particular application areas

► Increased environmental requirements

The module PSSu H FS2 SN SD-T is suitable for use where there are increased environmental requirements (see [Technical details \[31\]](#)).

► Lift applications

The modules PSSu H FS2 SN SD and PSSu H FS2 SN SD-T can be used as a PESS-RAL (programmable electronic system in safety-related applications for lifts) in accordance with the Lifts Directive 2014/33/EU. The modules meet the requirements in accordance with EN 81-20, EN 81-22, EN 81-50 for passenger and goods lifts, as well as the requirements in accordance with EN 115-1 for escalators and moving walks.

The module/the safety controller should be installed in a protected environment. Example: Protected inside space or control cabinet with protection class and corresponding air conditioning specified in [Technical details \[31\]](#).

Operating height

With reference to the standard IEC 61131-2 the values stated in the technical details for ambient temperature are reduced at heights >2000 m operating height above sea level (see [Supplementary data \[36\]](#)).

EMC-compliant installation

Intended use includes making the electrical installation EMC-compliant. Please refer to the guidelines stated in the "PSSuniversal Installation Manual". The module is intended for use in an industrial environment. Interference may occur if used within a domestic environment.

Improper use

The following is deemed improper use in particular

- Any component, technical or electrical modification to the module,
- Use of the module outside the areas described in this operating manual,
- Any use of the module that is not in accordance with the technical details.

Software tools

The module is supported by PAS4000 from Version 1.21.1.

**INFORMATION**

We recommend that you always use the latest version of the software tool (download from www.pilz.com).

3.2 Safety regulations

3.2.1 Use of qualified personnel

The products may only be assembled, installed, programmed, commissioned, operated, maintained and decommissioned by persons who are competent to do so.

A competent person is a qualified and knowledgeable person who, because of their training, experience and current professional activity, has the specialist knowledge required. To be able to inspect, assess and operate devices, systems and machines, the person has to be informed of the state of the art and the applicable national, European and international laws, directives and standards.

It is the company's responsibility only to employ personnel who

- ▶ Are familiar with the basic regulations concerning health and safety / accident prevention,
- ▶ Have read and understood the information provided in the section entitled Safety
- ▶ Have a good knowledge of the generic and specialist standards applicable to the specific application.

3.2.2 Warranty and liability

All claims to warranty and liability will be rendered invalid if

- ▶ The product was used contrary to the purpose for which it is intended,
- ▶ Damage can be attributed to not having followed the guidelines in the manual,
- ▶ Operating personnel are not suitably qualified,
- ▶ Any type of modification has been made (e.g. exchanging components on the PCB boards, soldering work etc.).

3.2.3 Disposal

- ▶ In safety-related applications, please comply with the mission time T_M in the safety-related characteristic data.
- ▶ When decommissioning, please comply with local regulations regarding the disposal of electronic devices (e.g. Electrical and Electronic Equipment Act).

4 Function description

4.1 Block diagram

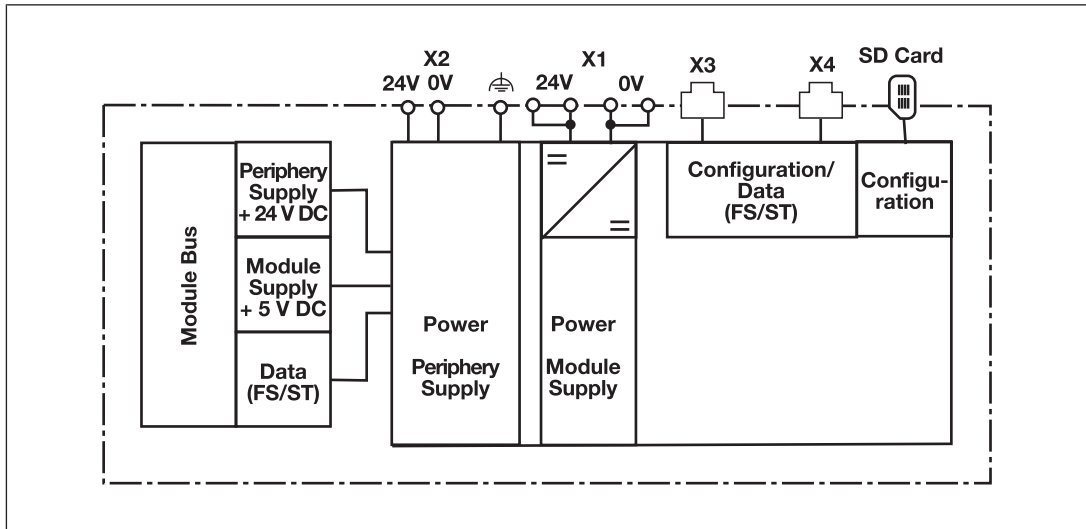

4.2 Supply voltage

4.2.1 Function description

The product provides the module supply and periphery supply for the modules on the module bus:

- ▶ Module supply
 - Supply voltage for subsequent module (right-hand side)
- ▶ Periphery supply
 - Supply voltage for sensors, actuators and test pulses

The periphery supply is monitored for undervoltage and overvoltage. The periphery supply does not switch off automatically if levels drop below the limit values. However, the red LED flashes and a message is entered in the diagnostic log.

- Monitored lower voltage value: 16.8 V
- Monitored upper voltage value: 32 V

The maximum time between two voltage measurements is 100 ms.

The maximum time that can elapse between the first time a value exceeds or falls below a voltage value and the reaction of the head module is 100 ms + cycle time of the FS module bus.

When the supply voltage is fed in separately, the module supply and periphery supply are galvanically isolated. If galvanic isolation is not required, a common power supply may be used for the periphery supply and module supply.

4.2.2 Current load capacity

Ensure you comply with the current load capacity of the module and periphery supply (see "Technical Details"). If the current load is higher, an additional supply voltage module is required to refresh the module supply and periphery supply.

► Module supply

The current load is the total current consumption of all the electronic and compact modules.

The module supply does not automatically switch off if values exceed or drop below their limits. However, the "5 V" LED will light and a message will be entered in the diagnostic list.

► Periphery supply

The current load is the total current consumption of the sensors, actuators and test pulses supplied via the input/output modules.

The periphery supply does not automatically switch off if values exceed or drop below their limits. However, the "24 V" LED will light and a message will be entered in the diagnostic list.

Please refer to the derating diagrams.

PSSu H FS2 SN SD: Derating diagram for periphery supply: Temperature T dependent on load current I

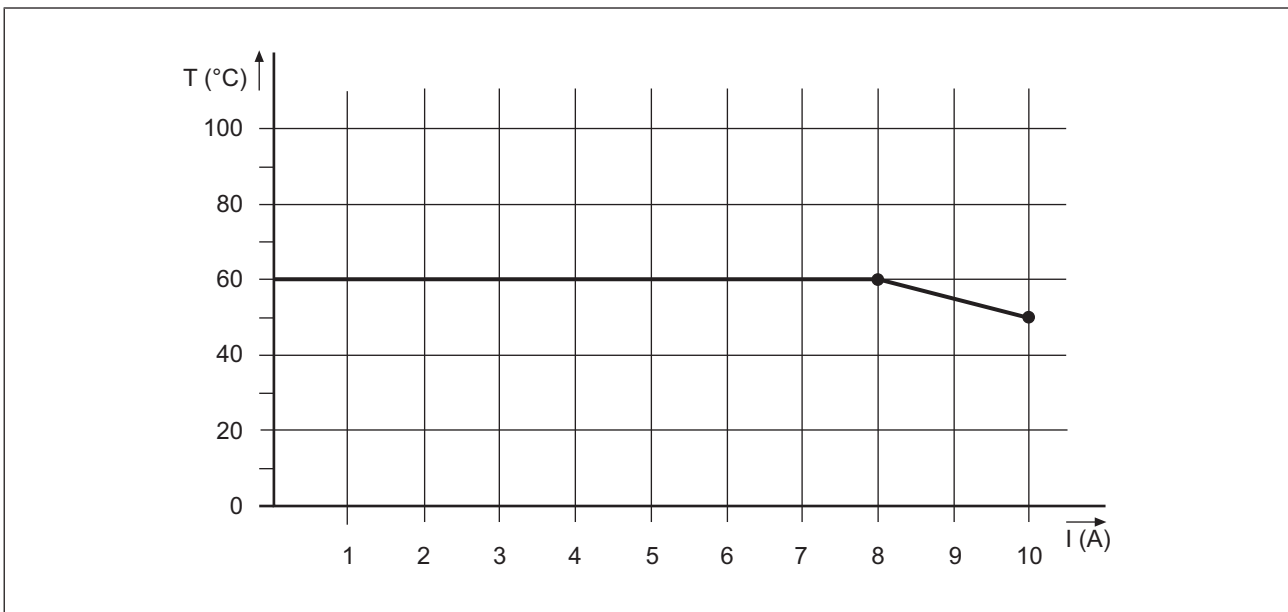

PSSu H FS2 SN SD(-T): Derating diagram for periphery supply: Permitted ambient temperature T dependent on load current I

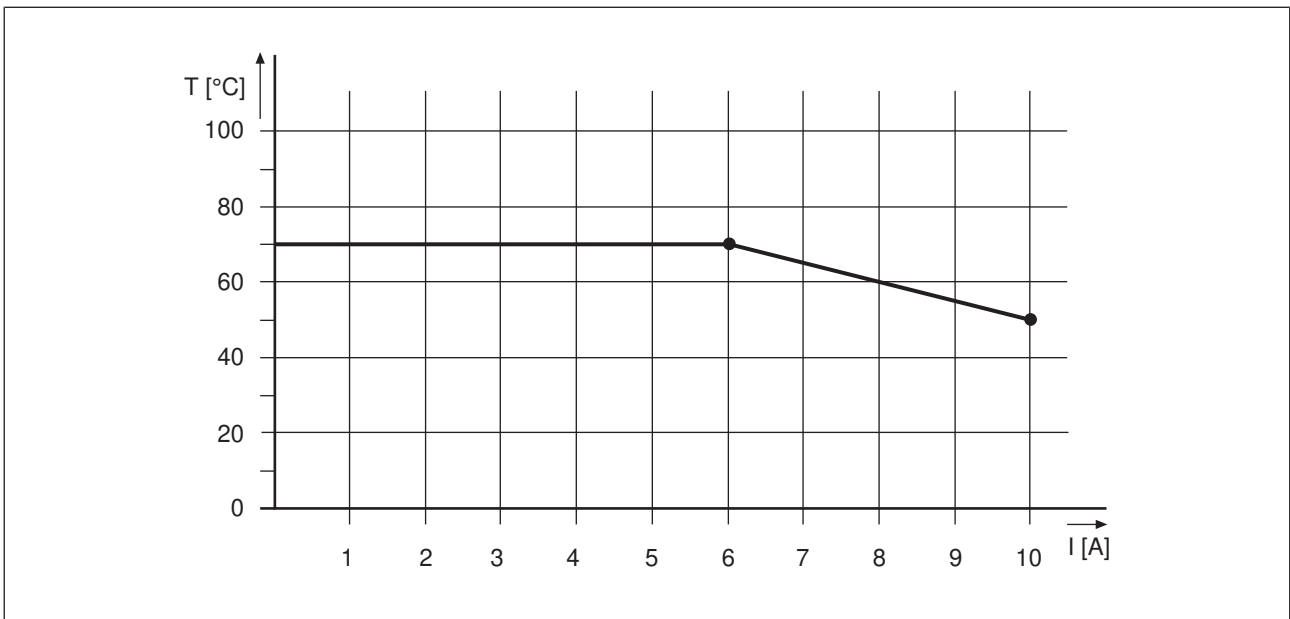

PSSu H FS2 SN SD(-T): Derating diagram for infeed for module supply: Permitted ambient temperature T dependent on load current I

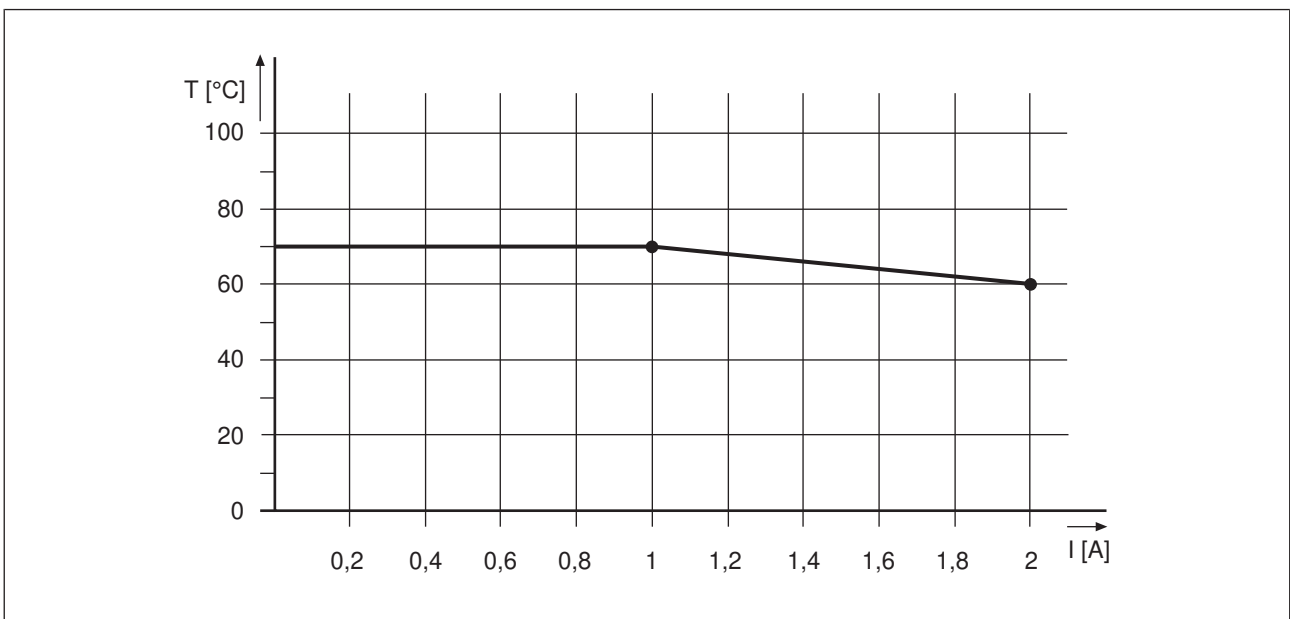

4.3 Integrated protection mechanisms

The module has the following protection mechanisms:

- ▶ multi-channel diverse processor section
- ▶ cyclical self tests
- ▶ Potentially isolated **SafetyNET p** interface
- ▶ Module supply
 - Polarity protection
 - Short circuit-proof
 - Voltage monitoring (exceeding upper/lower limit)
 - Transient voltage limitation
 - 20 ms voltage buffer if the supply voltage is interrupted
- ▶ Periphery supply
 - Voltage monitoring (exceeding upper/lower limit)
- ▶ CPU
 - Temperature monitoring
 - Voltage monitoring (exceeding upper/lower limit)

4.4 SafetyNET p

4.4.1 Connection to SafetyNET p

Functions

- ▶ The SafetyNET p interface enables I/Os to be controlled by means of a higher level control system (e.g. PSSu PLC).
- ▶ The head module receives signals from a higher level control system and forwards them to the connected input/output modules.
- ▶ The head module receives signals from the connected input/output modules and forwards them to a higher level control system.
- ▶ If a fault occurs, the module switches the connected failsafe outputs to a safe condition.

MAC address

- ▶ The MAC address is a factory-set default. It can be found on the labelling strip on the front of the module.



INFORMATION

Further information on SafetyNET p can be found in the "PSS 4000 System Description".

4.5 Decentralised inputs and outputs

The head module belongs to the performance class "Decentralised system PSSu I/O". It enables the PSSuniversal to be used as a modular, decentralised input/output module:

- ▶ PSSu system without control functionality
- ▶ Electronic modules and/or compact modules must be added to the head module
- ▶ I/Os are controlled via SafetyNET p by means of a control system (e.g. PSSu PLC)

4.6 SD card

The SD card has the following functions:

- ▶ The SD card is used to store the naming data and the device project; see PSS 4000 System Description.
- ▶ The SD card is part of the safety concept on PSS 4000. If the SD card is missing or has been swapped, the next time the PSSu system is booted it will be unable to achieve the operating status "PSSu System in RUN condition without error". The SD card has a locking mechanism, which protects it from being removed from the card holder unintentionally. The SD card can also be sealed to protect it from manipulation, whether accidental or intentional.

Sealing the SD card for additional protection:

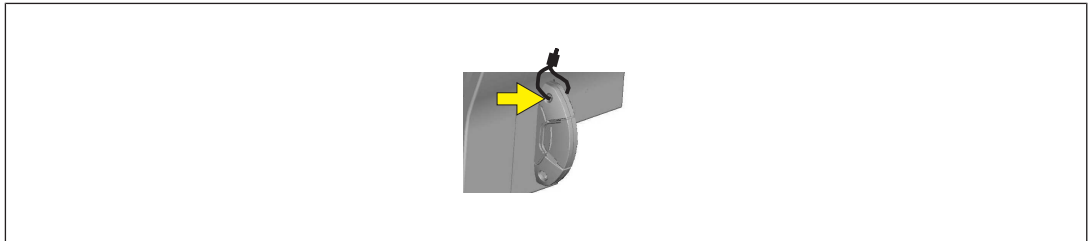

Security SD cards

The head module supports the use of security ID cards. The security SD card contains not only the device project and the naming data, but also special data that is required for security functions. The security functions include in particular the protection of a PSS 4000 project against unauthorised access or use. In PAS4000, the device project can be linked with the security SD card for this purpose. Security SD cards are available from Pilz, for example, under the designation "PASkey SD card".



NOTICE

Damage to files on the SD card

Files may be damaged if the card is removed from the device or the power to the device is switched off as the SD card is being written.

Remove the SD card only in recovery mode or in switched-off state.

4.7 Reset button

The "Reset" pushbutton on the head module has various functions:

- ▶ Perform a warm reset for the PSSu system.

The reset pushbutton can be used to perform a warm reset for the PSSu system.

- ▶ Transfer the naming data and/or device project from the SD card (deliberate operator action to transfer the naming data and/or device project from the SD card to the device memory).
- ▶ Perform recovery mode.



INFORMATION

The warm reset and the recovery mode and transfer of the naming data and/or device project are described in the "PSS 4000 System Description". This is also where the general effects on the PSSu system are described in detail.

5 Installation

5.1 General installation guidelines

Please also refer to the PSSuniversal Installation Manual.

The description below assumes that the mounting rail is already installed.



NOTICE

Damage due to electrostatic discharge!

Electrostatic discharge can damage components. Ensure against discharge before touching the product, e.g. by touching an earthed, conductive surface or by wearing an earthed armband.

5.2 Dimensions

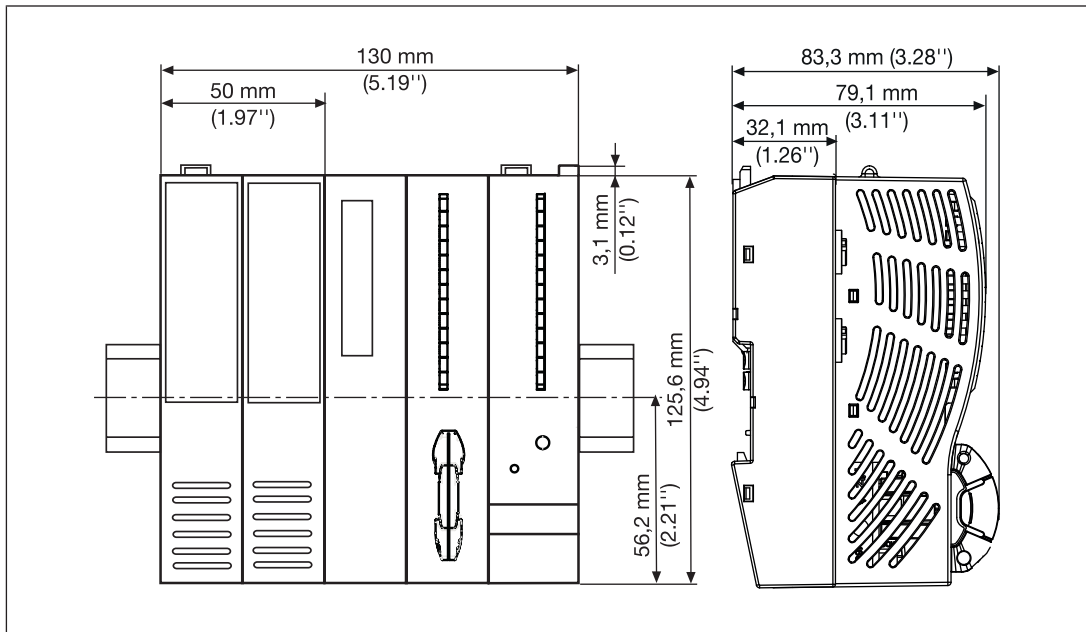

5.3 Installing the head module

Prerequisite:

- ▶ The mounting rail must be installed.

Please note:

- ▶ All contacts should be protected from contamination.

Procedure:

- ▶ Install an end bracket to the left of the head module or leave enough space for one.
- ▶ Slot the groove on the head module on to the mounting rail from below [1].
- ▶ Push the head module back as far as it will go [2].
- ▶ Make sure that the locking mechanisms [3] are pushed downwards, connecting the module firmly to the mounting rail.

Schematic representation:

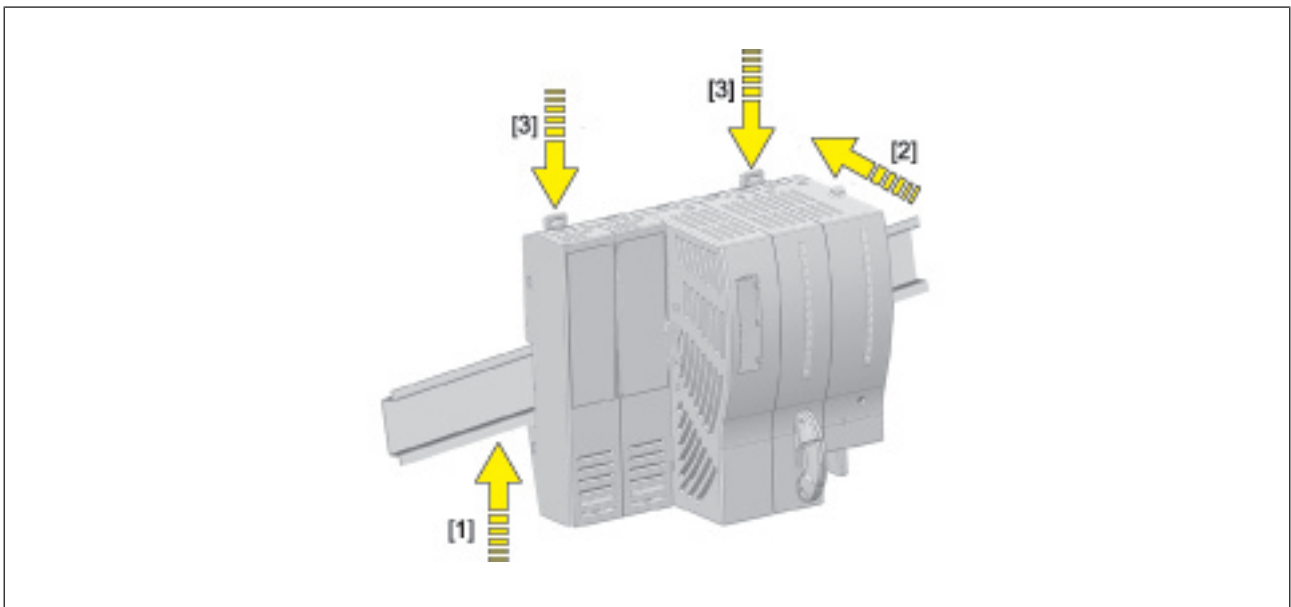

6 Interface assignment

Further information on the Ethernet interface can be found in the system description PSS 4000.

Assignment of the interfaces on head modules with an RJ45 female connector

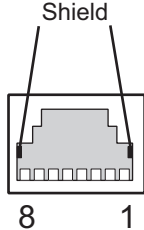

SafetyNET p	Assignment	
RJ45 female connector	1: TD+ 2: TD- 3: RD+ 4: n.c. 5: n.c. 6: RD- 7: n.c. 8: n.c.	 <p>The diagram shows a cross-section of an RJ45 female connector. A central shield is labeled 'Shield'. Two lines point from the label to the shield. Below the shield, the positions of the eight pins are shown, with the numbers '8' and '1' indicating the positions of the first and last pins respectively.</p>

► n.c. = not connected

7 Wiring

7.1 General wiring guidelines

Please note:

- ▶ The requirements for the supply voltages can be found in the chapter entitled [Technical details](#)  31].
- ▶ Protective separation must be ensured for the external power supplies that generate the supply voltages. Failure to do so could result in electric shock.
- ▶ The external power supplies for generating the supply voltages (periphery supply and module supply) must meet the regulations for extra low voltages with protective electrical separation (SELV, PELV). Failure to do so could result in electric shock. A device with a basic insulation that has a supply voltage of over 50 VAC or 120 VDC must not be connected in parallel to the module supply.
- ▶ The external power supplies must comply with the current applicable standard EN 62368-1 or EN 61010-2-201.
- ▶ The maximum current load for the periphery supply on the module bus is 10 A. Please refer to the derating diagram in the chapter entitled "Function Description".
- ▶ Earth the 0 V supply on the periphery supply or monitor each supply group for earth faults.
- ▶ The connection of the 0 V supply to the central earth bar or earth fault monitor must be in accordance with relevant national regulations (e.g. EN 60204-1, NFPA 79:17-7, NEC: Article 250).
- ▶ Details of the minimum range for cable cross sections on connection terminals can be found under [Technical details](#)  31].
- ▶ Use copper wiring.

7.2 Terminal configuration

Module supply	Terminal configuration		X1
4-pin female connector	24V	+24 V infeed for module supply	
	0V	0 V infeed for module supply	
Periphery supply	Terminal configuration		X2
4-pin female connector	24V:	+24 V infeed for periphery supply	
	0V	0 V infeed for periphery supply	
		Functional earth	

7.3 Connecting the module

Separate power supplies for module supply and periphery supply:

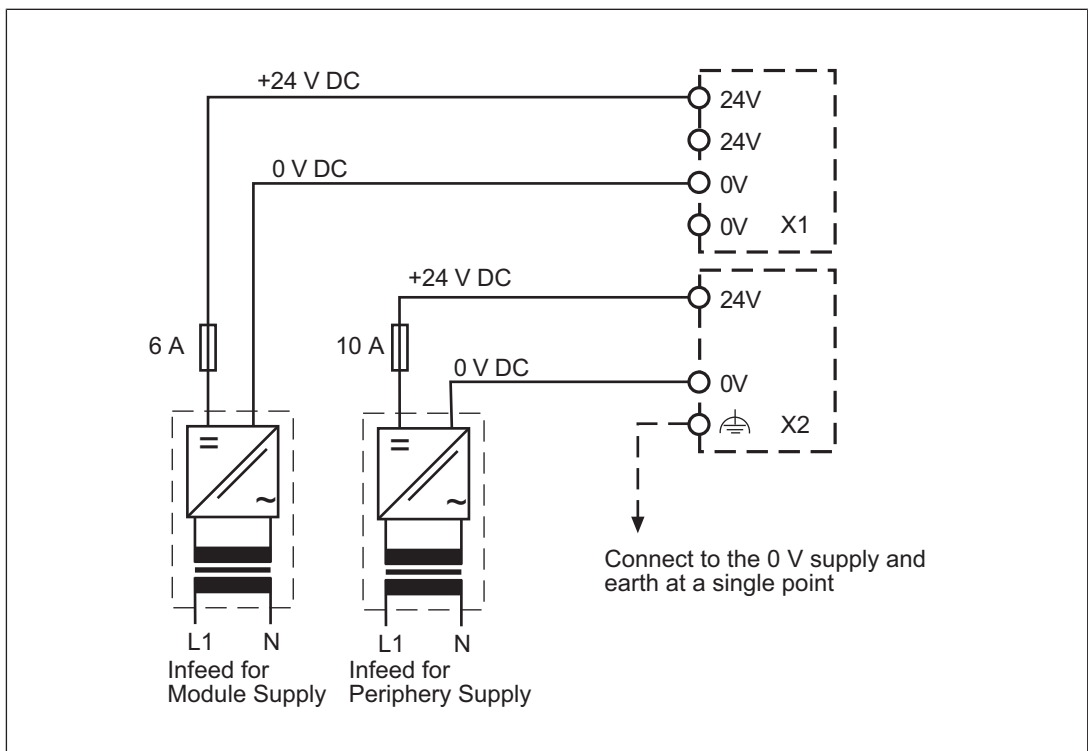

Common power supply for module supply and periphery supply:

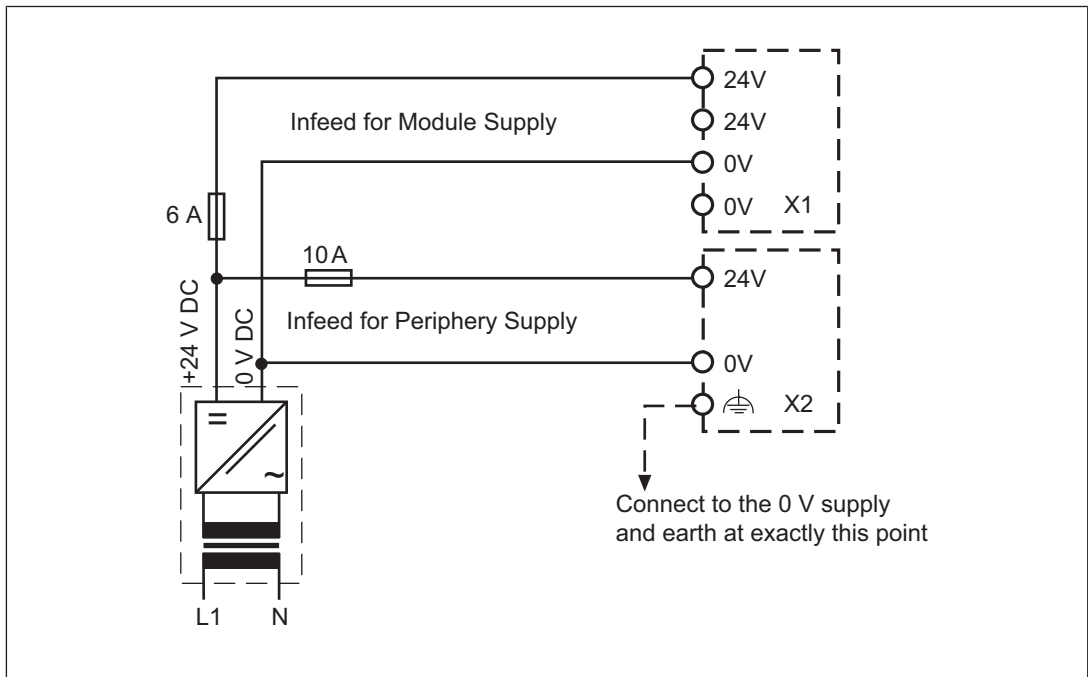

8 Operation

8.1 Messages

The PSSu system provides many options for diagnostics, fault detection and communication with other control systems.

Diagnostics for the PSSu system can be run via the

- ▶ LEDs on the head module,
- ▶ Diagnostic table and diagnostic log.

All errors and faults detected by the electronic or compact modules in a PSSu system are signalled to the head module and entered in the diagnostic table and diagnostic log. You can read the head module's diagnostic table and diagnostic log, e.g. using the PAS4000 or the combination of OPC Server and PSS 4000 Diag Control.

8.2 Display elements

The head module contains a number of status LEDs, which provide information on the status of various system sections.

LEDs on the PSSu H FS2 SN SD:

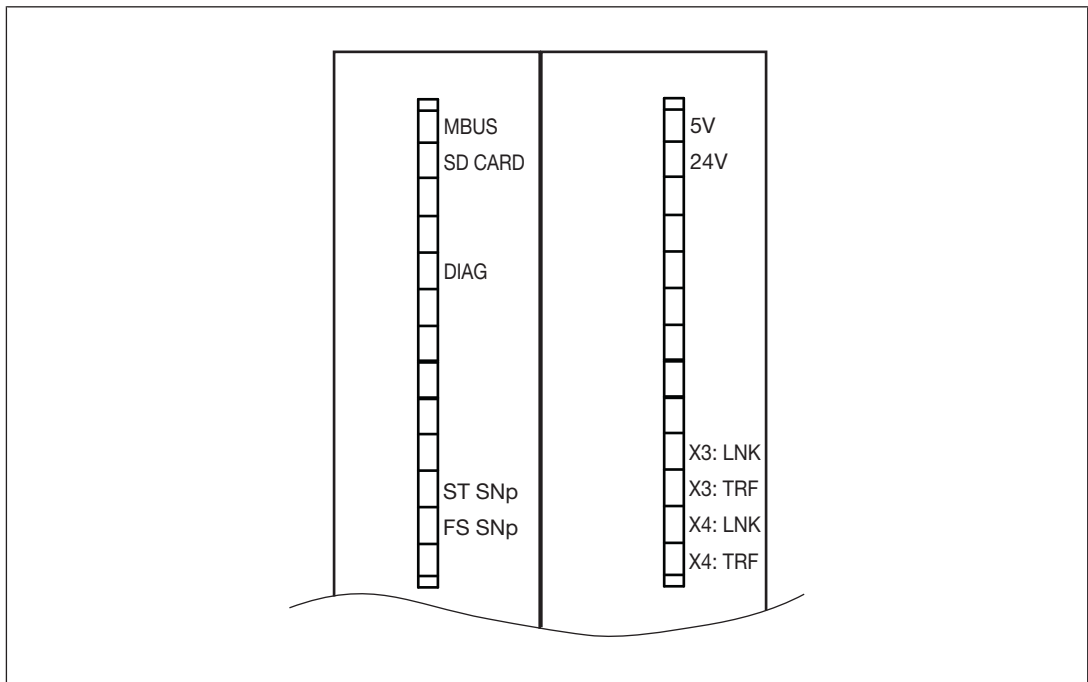



INFORMATION

When the PSSu system is restarted, the LEDs in the head module's left-hand column light up green in succession (green chase light). This indicates that a released firmware version from Pilz is installed. If a red chase light is displayed, then a test version of the firmware is installed on the head module. If a test version is installed, this is also indicated during operation. In this case, the "DIAG" LED flashes red.

Legend



LED on



LED flashes



LED flashes



LED off

8.2.1







MBUS

The "MBUS" LED indicates the status of the FS and ST module bus.

Colour	Status	Meaning
---		No modules are configured and no modules are available.
Green		FS and ST module bus are operating without error
Red		Operating state "Safe state of all FS outputs on the PSSu system" or Unable to locate at least one module (e.g. a module has been removed during operation, set/actual hardware registry does not match)
		Operating state "FS module bus in STOP state with error: major FS error"









8.2.2 SD CARD

The LED indicates the status of the SD card and is used for device identification.

Colour	Status	Meaning
- - -		Supply voltage for module supply is missing
Red		<ul style="list-style-type: none"> ▶ SD card is missing or ▶ SD card not recognised or ▶ SD card defective or ▶ Recovery mode: For some reason, the file system of the SD card could not reconstruct a consistent state.
		<ul style="list-style-type: none"> ▶ "Bind device projects to devices" function: <ul style="list-style-type: none"> – The device does not have the device key that matches the device project. or – The device project does not have the project key that matches the device. and/or ▶ "Bind device projects to SD cards" function: <ul style="list-style-type: none"> The device project is bound to an SD card, but this SD card is not inserted in the device.
Green		Naming data and device project on the device and SD card match
		<ul style="list-style-type: none"> ▶ Product type on the SD card does not match the product type of the device/head module or ▶ No device project on the SD card or ▶ Recovery mode: The file system of the SD card is in a consistent state and the SD card can be removed.
Green-red		Naming data and device project on the device and SD card do not match
Orange		<ul style="list-style-type: none"> Device identification activated by user ▶ Identification as PSS 4000 device in SafetyNET p (PAS4000) or ▶ Identification as PROFINET IO Device in PROFINET (engineering tool for PROFINET)





8.2.3 DIAG

The "DIAG" LED indicates whether there is a fault in a system section. Precise evaluation can be made via the diagnostic list.

Colour	Status	Meaning
- - -		No system section is started, module supply is missing.
Green		No message of "Error" or "Warning" severity is present for the device.
		Device diagnostic list and device diagnostic log are being prepared
Red		A message of "Error" severity is present for at least one system section (see diagnostic table).
		<ul style="list-style-type: none"> ▶ A major FS error is present for at least one FS system section (see diagnostic list). or <ul style="list-style-type: none"> ▶ The boot process was stopped because an internal error occurred or the firmware version has been manipulated. Diagnostics are no longer available. The reset button has no function.
		The installed PSS 4000 firmware has not been released. The firmware version is a test version, which may only be used for test purposes.
Orange		A message of at least "Warning" severity is present for the device (see diagnostic list).
Red - green		Start of "deliberate operator action" (function of reset pushbutton)





8.2.4 ST SNp

The "ST SNp" LED indicates the status of the non-safety-related system section ST SafetyNET p.

Colour	Status	Meaning
- - -		System section ST SafetyNET p has not been started
Green		Operating state "ST SafetyNET p in RUN state without error"
		Operating state "ST SafetyNET p in RUN state with minor error"
Red		Operating state "ST SafetyNET p in STOP state with error: Major FS+ST error"
		



8.2.5 FS SNp

The "FS SNp" LED indicates the status of the safety-related system section FS SafetyNET p.



Colour	Status	Meaning
- - -		System section FS SafetyNET p has not been started
Green		Operating state "FS SafetyNET p in RUN state without error"
		Operating state "FS SafetyNET p in RUN state with minor error"
Red		Operating state "FS SafetyNET p in STOP state with error: Major FS error"
		Operating state "FS SafetyNET p in STOP state with error: Major FS+ST error"

8.2.6 5V, 24V

The "5 V" LED indicates the status of the module supply.

Colour	Status	Meaning
- - -		No supply voltage for module supply or supply voltage is faulty
Green		Module supply is available



The "24 V" LED indicates the status of the periphery supply.

Colour	Status	Meaning
- - -		No supply voltage for periphery supply or supply voltage is faulty
Green		Periphery supply is available

8.2.7 X3: LNK, X3: TRF, X4: LNK, X4: TRF



A PSSu system can have either one Ethernet interface (X3) or two Ethernet interfaces (X3 and X4) (see Ethernet interface). An Ethernet interface is assigned two status LEDs on the head module as display elements. The status LEDs indicate various connection and communication states.

X3: LNK, X3: LNK

Colour	Status	Meaning
---		No network connection
Green		Network connection is error-free

The designation "LNK" stands for "LINK".

X3: TRF, X4: TRF

Colour	Status	Meaning
---		No data traffic
Yellow		Data traffic is error-free

The designation "TRF" stands for "TRAFFIC".

9 Technical details

General	312087	314087
Certifications	CE, EAC, TÜV, UKCA, cULus Listed	CE, EAC, TÜV, UKCA, cULus Listed
Application range	Standard/failsafe	Standard/failsafe
System sections	312087	314087
ST resource	No	No
FS resource	No	No
ST module bus PSSu	Yes	Yes
FS module bus PSSu	Yes	Yes
ST SNp interface	Yes	Yes
FS SNp interface	Yes	Yes
PROFIBUS-DP Slave	No	No
PROFINET IO DEVICE	No	No
IP connections	No	No
Diagnostic Server	No	No
OPC Server	No	No
Programming	312087	314087
IEC 61131 programming	No	No
Multi programming	No	No
Non-volatile variables	No	No
Electrical data	312087	314087
Supply voltage		
for	Module supply	Module supply
Voltage	24 V	24 V
Kind	DC	DC
Voltage tolerance	-30 %/+25 %	-30 %/+25 %
Max. continuous current that the external power supply must provide	1 A	1 A
Output of external power supply (DC)	17 W	17 W
Supply voltage		
for	Periphery supply	Periphery supply
Voltage	24 V	24 V
Kind	DC	DC
Voltage tolerance	-30 %/+25 %	-30 %/+25 %
Max. continuous current that the external power supply must provide	10 A	10 A

Electrical data	312087	314087
Internal supply voltage (module supply)		
Output voltage	int. system	int. system
Voltage	5 V	5 V
Kind	DC	DC
Voltage tolerance	-2 %/+3 %	-2 %/+3 %
Current load capacity	2 A	2 A
Buffer in the case of supply interruptions in accordance with	EN 61131-2	EN61131-2
Short circuit-proof	Yes	Yes
CPU	312087	314087
Real-time clock for time and date functions		
Resolution	1 s	1 s
Deviation	+/- 10s/day	+/- 10s/day
Buffer time	10 days	10 days
Working memory (RAM)	256 MB	256 MB
Removable data medium	312087	314087
Type	SD card	SD card
SafetyNET p interface	312087	314087
Quantity	2	2
IP address (automatically off)	169.254.X.Y	169.254.X.Y
Connection	RJ45	RJ45
Transmission rates	100 MBit/s	100 MBit/s
Set via	Automatic	Automatic
Max. number of ST-Tx and ST-Rx connections	64	64
Max. number of FS-Tx and FS-Rx connections	64	64
Cycle time (t _{SNp} RTFN)	2 ... 60 000 ms	2 ... 60 000 ms
Environmental data	312087	314087
Climatic suitability	EN 60068-2-1, EN 60068-2-14, EN 60068-2-2, EN 60068-2-30, EN 60068-2-78	EN 60068-2-1, EN 60068-2-14, EN 60068-2-2, EN 60068-2-30, EN 60068-2-78
Ambient temperature		
Temperature range	0 - 60 °C	-40 - 70 °C
Storage temperature		
Temperature range	-40 - 70 °C	-40 - 70 °C
Climatic suitability in accordance with the standard	EN 60068-2-78	EN 60068-2-78
Humidity	93 % r. h. at 40 °C	93 % r. h. at 40 °C
Condensation during operation	Not permitted	EN 60068-2-30, short-term
Max. operating height above SL	2000 m	5000 m
EMC	EN 61000-6-2, EN 61000-6-4, EN 61131-2 (Zone B)	EN 61000-6-2, EN 61000-6-4, EN 61131-2 (Zone B)

Environmental data	312087	314087
Vibration		
in accordance with the standard	EN 60068-2-6	EN 60068-2-6
Frequency	8,4 - 150 Hz	8,4 - 150 Hz
Acceleration	10 m/s²	10 m/s²
Broadband noise		
in accordance with the standard	–	EN 60068-2-64
Frequency	–	5 - 500 Hz
Acceleration	–	19 m/s² eff.
Shock stress		
in accordance with the standard	EN 60068-2-27	EN 60068-2-27
Number of shocks	6	6
Acceleration	150 m/s²	150 m/s²
Duration	11 ms	11 ms
Airgap creepage		
in accordance with the standard	EN 61131-2	EN 61131-2
Overvoltage category	II	II
Pollution degree	2	2
Protection type		
Housing	IP20	IP20
Mounting area (e.g. control cabinet)	IP54	IP54
Potential isolation	312087	314087
Potential isolation between	Periphery supply and module supply	Periphery supply and module supply
Type of potential isolation	Functional insulation	Functional insulation
Rated surge voltage in operating heights up to max. 2000 m	2000 V	2000 V
Rated surge voltage in operating heights up to max. 5000 m	–	1500 V
Potential isolation between	Periphery supply and system voltage	Periphery supply and system voltage
Type of potential isolation	Functional insulation	Functional insulation
Rated surge voltage in operating heights up to max. 2000 m	2000 V	2000 V
Rated surge voltage in operating heights up to max. 5000 m	–	1500 V
Mechanical data	312087	314087
Material		
Bottom	PC	PC
Connection type	Spring-loaded terminal, screw terminal	Spring-loaded terminal, screw terminal
Mounting type	plug-in	plug-in

Mechanical data	312087	314087
Conductor cross section with screw terminals		
1 core flexible	0,25 - 2,5 mm², 24 - 12 AWG	0,25 - 2,5 mm², 24 - 12 AWG
2 core with the same cross section, flexible with crimp connectors, no plastic sleeve	0,25 - 1 mm², 24 - 16 AWG	0,25 - 1 mm², 24 - 16 AWG
2 core with the same cross section, flexible without crimp connectors or with TWIN crimp connectors	0,2 - 1,5 mm², 24 - 16 AWG	0,2 - 1,5 mm², 24 - 16 AWG
Torque setting with screw terminals	0,5 Nm	0,5 Nm
Conductor cross section with spring-loaded terminals: Flexible with/without crimp connector	0,2 - 2,5 mm², 24 - 12 AWG	0,2 - 2,5 mm², 24 - 12 AWG
Stripping length with spring-loaded terminals	9 mm	9 mm
Dimensions		
Height	125,6 mm	125,6 mm
Width	130 mm	130 mm
Depth	83,7 mm	83,7 mm
Weight	350 g	350 g

Where standards are undated, the 2022-01 latest editions shall apply.

9.1 Safety characteristic data



NOTICE

You must comply with the safety characteristic data in order to achieve the required safety level for your plant/machine.

If the module is operated at an ambient temperature above 60° C, the values stated in the table for PFH_D and PFD will need to be doubled when a safety function is calculated.

All the units used within a safety function must be considered when calculating the safety characteristic data.

Operating mode	EN ISO 13849-1: 2015 PL	EN ISO 13849-1: 2015 Category	EN IEC 62061 SIL CL/ maximum SIL	EN IEC 62061 PFH _D [1/h]	EN/IEC 61511 SIL	EN/IEC 61511 PFD	EN ISO 13849-1: 2015 T _M [year]
2-channel	PL e	Cat. 4	SIL CL 3	6,25E-10	SIL 3	5,17E-05	20



INFORMATION

A safety function's SIL/PL values are **not** identical to the SIL/PL values of the units that are used and may be different. We recommend that you use the PAScal software tool to calculate the safety function's SIL/PL values.

10 Supplementary data

10.1 Permitted operating height

The values stated in the technical details apply to the use of the device in operating heights up to max. 2000 m above SL. When used at higher levels, restrictions of the ambient temperature (standard IEC 61131-2) must be taken into account.

Operating height above SL [m]	Multiplication factors for the devices' ambient temperature
0 ... 2000	1.0
3000	0.9
4000	0.8
5000	0.7

11 Order reference

11.1 Product

Product type	Features	Order no.
PSSu H FS2 SN SD	Head module with SafetyNET p interface, base type	312087
PSSu H FS2 SN SD-T	Head module with SafetyNET p interface, T-type	314087

11.2 Accessories

SD cards

Product type	Features	Order no.
SD memory card 1 GB with PSSu holder	SD memory card 1 GB for PSSu head module including card holder	313102
Memory card 4 GB with PSSu holder	SD memory card 4 GB for PSSu head modules including card holder (optional)	313103
PASkey SD card 4 GB with PSSu holder	Security SD card with 4 GB and additional safe memory for encrypted contents such as licenses or copy protection including card holder (optional)	317801

Cable

Product type	Features	Order no.
SafetyNET p cable	SafetyNET p cable, standard, 4-core, sold by the metre, minimum purchase 10 m	380000
M12 con., straight, male, 4-pin, D	Connector, M12, 4-pin, D-coded	380316
SafetyNET p connector RJ45s	RJ45 plug-in connector, straight, IP20, 4-pin, Cat5e, AWG 22 (4-core), cable diameter: 6.3 - 6.7 mm	380400
RJ45 Connector	RJ45 plug-in connector, straight, IP20, 8-pin, Cat6a, IDC connection, AWG 22, cable diameter: 5.5 - 8.5 mm	380401
Stripping tool	Assembly tool for SafetyNET p cable	380070

Terminals

Product type	Features	Order no.
PSSu A Con 1/4 S	2 x screw terminals	313110
PSSu A Con 2/8 C	2 x spring-loaded terminals	313111

12 **EC declaration of conformity**

This product/these products meet the requirements of the directive 2006/42/EC on machinery of the European Parliament and of the Council. The complete EC Declaration of Conformity is available on the Internet at www.pilz.com/downloads.

Representative: Pilz GmbH & Co. KG, Felix-Wankel-Str. 2, 73760 Ostfildern, Germany

13 UKCA-Declaration of Conformity

This product(s) complies with following UK legislation: Supply of Machinery (Safety) Regulation 2008.

The complete UKCA Declaration of Conformity is available on the Internet at www.pilz.com/downloads.

Representative: Pilz Automation Technology, Pilz House, Little Colliers Field, Corby, Northamptonshire, NN18 8TJ United Kingdom, eMail: mail@pilz.co.uk

Support

Technical support is available from Pilz round the clock.

Americas

Brazil

+55 11 97569-2804

Canada

+1 888 315 7459

Mexico

+52 55 5572 1300

USA (toll-free)

+1 877-PILZUSA (745-9872)

Asia

China

+86 400-088-3566

Japan

+81 45 471-2281

South Korea

+82 31 778 3300

Australia and Oceania

Australia

+61 3 95600621

New Zealand

+64 9 6345350

Europe

Austria

+43 1 7986263-444

Belgium, Luxembourg

+32 9 3217570

France

+33 3 88104003

Germany

+49 711 3409-444

Ireland

+353 21 4804983

Italy, Malta

+39 0362 1826711

Scandinavia

+45 74436332

Spain

+34 938497433

Switzerland

+41 62 88979-32

The Netherlands

+31 347 320477

Türkiye

+90 216 5775552

United Kingdom

+44 1536 462203

You can reach our international hotline on:

+49 711 3409-222

support@pilz.com

Pilz develops environmentally-friendly products using ecological materials and energy-saving technologies. Offices and production facilities are ecologically designed, environmentally-aware and energy-saving. So Pilz offers sustainability, plus the security of using energy-efficient products and environmentally-friendly solutions.



CECE[®], CHRE[®], CMSE[®], INDUSTRIAL P[®], Leansafe[®], Myzei[®], PAS4000[®], PASscal[®], PASconfig[®], Pilz[®], PIT[®], PMSprimo[®], PMSprotego[®], PMCiendo[®], PMD[®], PMI[®], PNOZ[®], Primo[®], PSEN[®], PSS[®], PVS[®], SafetyBUS p[®], SafetyNET p[®], THE SPIRIT OF SAFETY[®] are registered and protected trademarks of Pilz GmbH & Co. KG in some countries. We would point out that product features may vary from the details stated in this document, depending on the status at the time of publication and the scope of the equipment. We accept no responsibility for the validity, accuracy and entirety of the text and graphics presented in this information. Please contact our Technical Support if you have any questions.

1005194-EN-09, 2024-10 Printed in Germany
© Pilz GmbH & Co. KG, 2019

We are represented internationally. Please refer to our homepage www.pilz.com for further details or contact our headquarters.

Headquarters: Pilz GmbH & Co. KG, Felix-Wankel-Straße 2, 73760 Ostfildern, Germany
Telephone: +49 711 3409-0, E-Mail: info@pilz.com, Internet: www.pilz.com

PILZ
THE SPIRIT OF SAFETY