

1 2 3 4 5 6 7 8

A
B
C
D
E
F

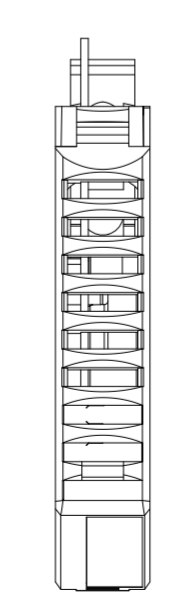

-	20240103	29.04.2024	PD-SUP-MCPD-SUP-MD	Neue Zeichnung. New drawing.
Index	ECO no.	Date	Editor	Checked
Scale	1:1	DIN A2		Date
Material	-	-	-	Name
-	-	-	-	MODEL: DRW 2036537
-	-	-	-	DRW: 2036539 -
Surface	-	-	-	Created
-	-	-	-	29.04.2024
-	-	-	-	PD-SUP-MD
-	-	-	-	Checked
-	-	-	-	29.04.2024
-	-	-	-	PD-SUP-MD
-	-	-	-	Norm
-	-	-	-	-
-	-	-	-	-
-	-	-	-	All dimensions are in mm
-	-	-	-	Unspecified tolerance
-	-	-	-	Doc.-No.
-	-	-	-	2036539
-	-	-	-	Page
-	-	-	-	1
-	-	-	-	Mat.-No.
-	-	-	-	of
-	-	-	-	1

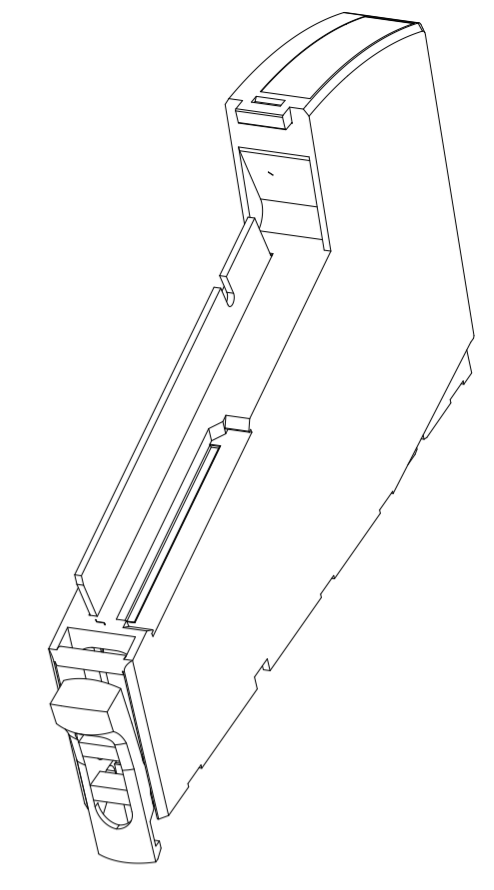
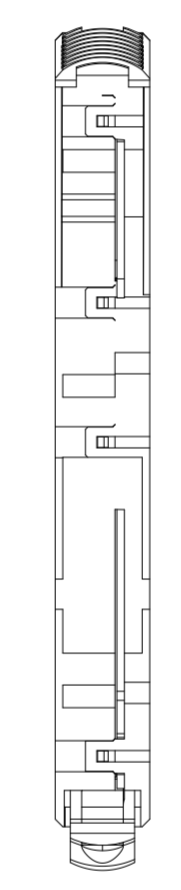
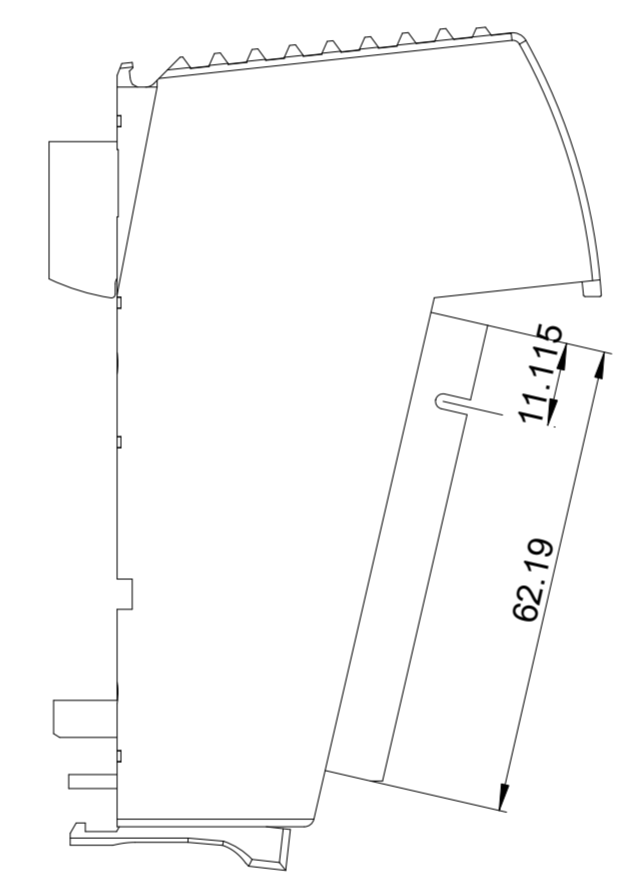
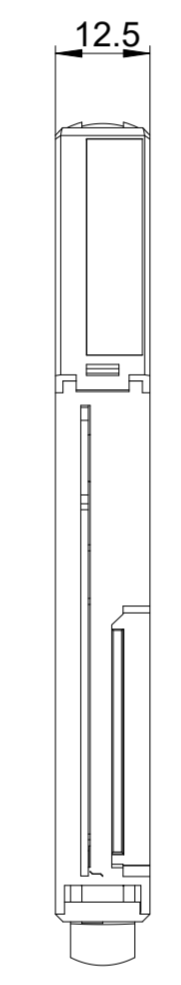
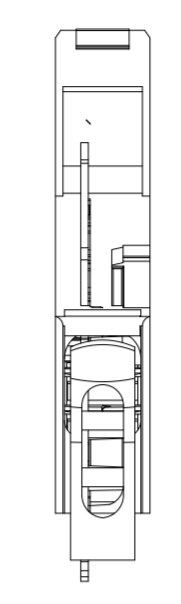
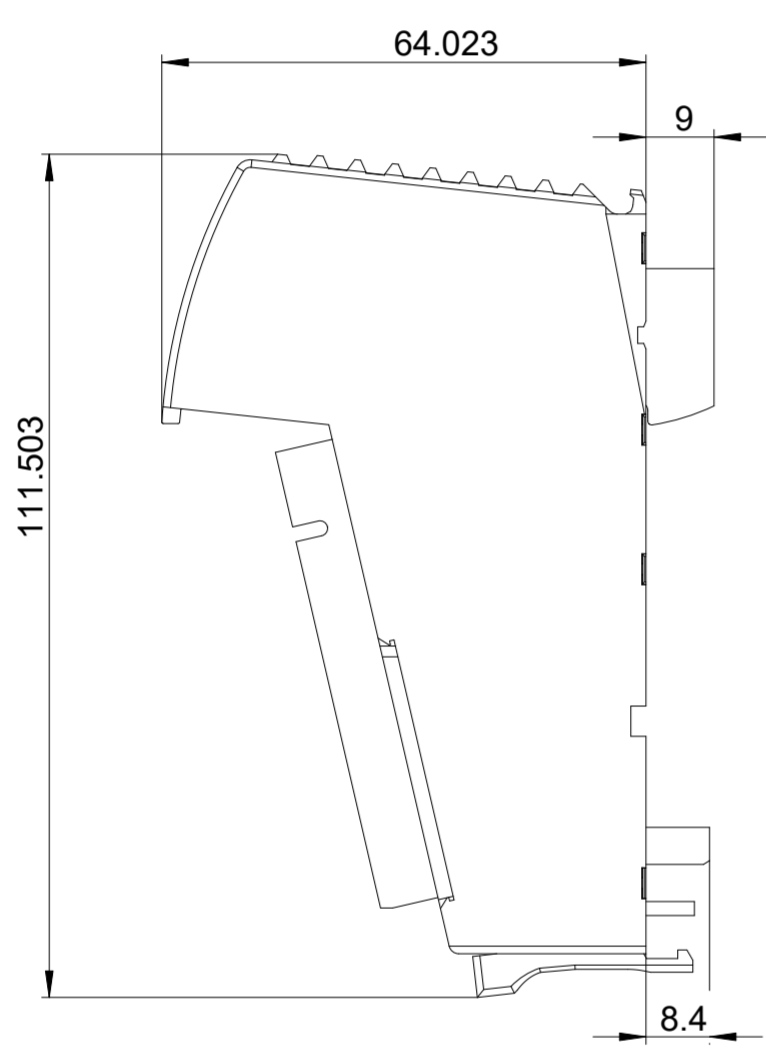

Refer to protection notice ISO 16016