

1 2 3 4 5 6 7 8

A

A

B

B

C

C

D

D

E

E

F

F

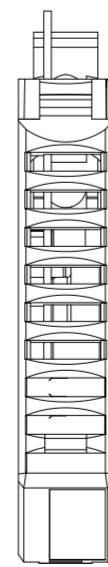
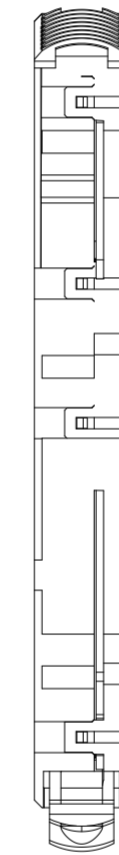
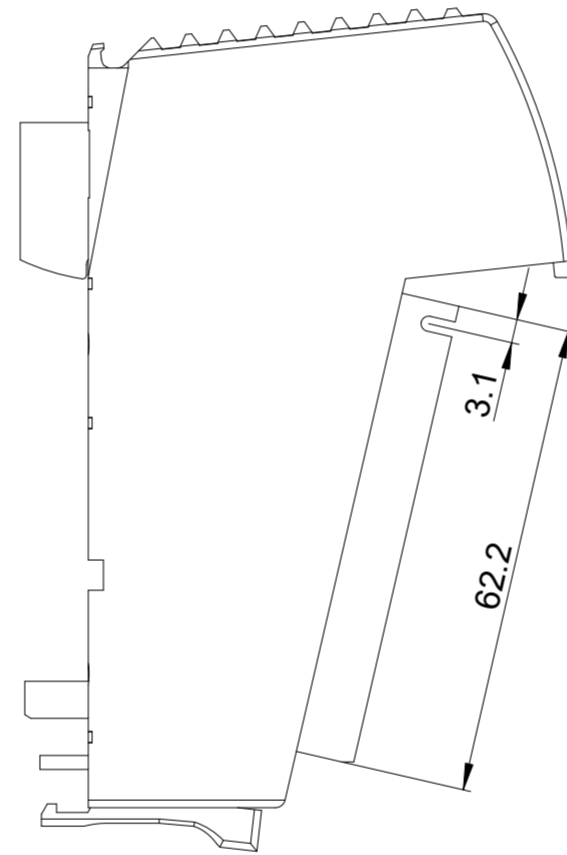
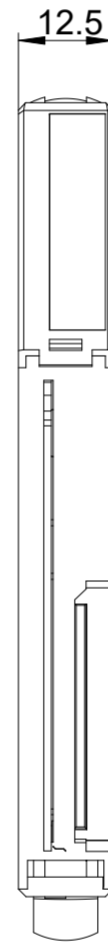
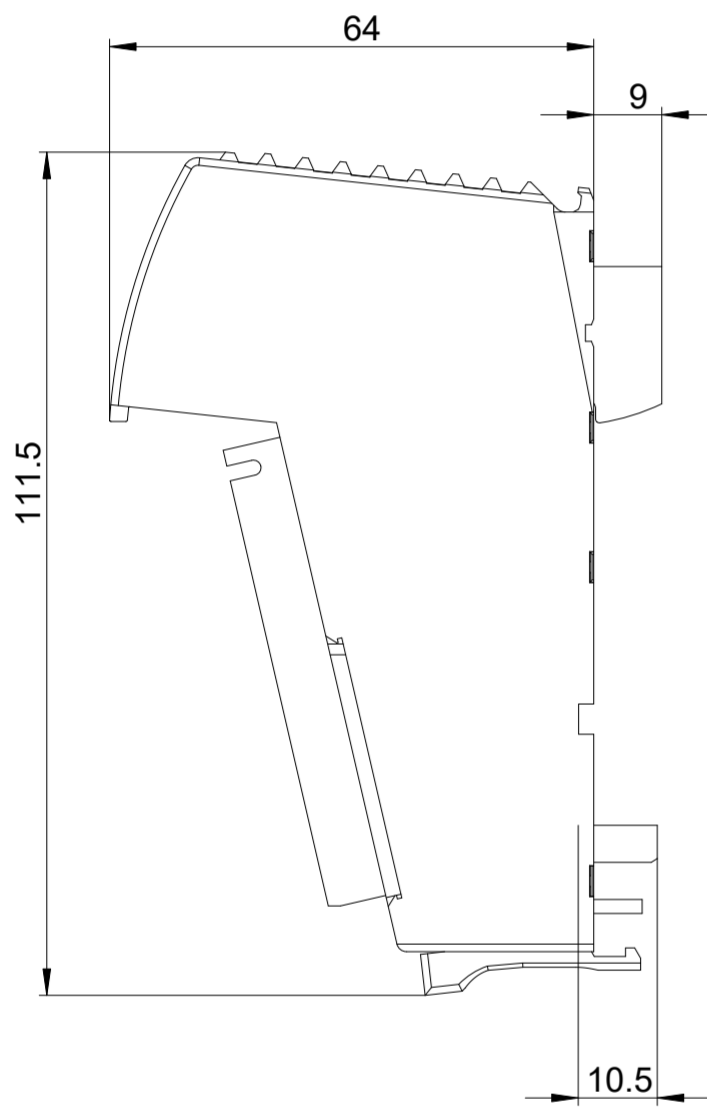
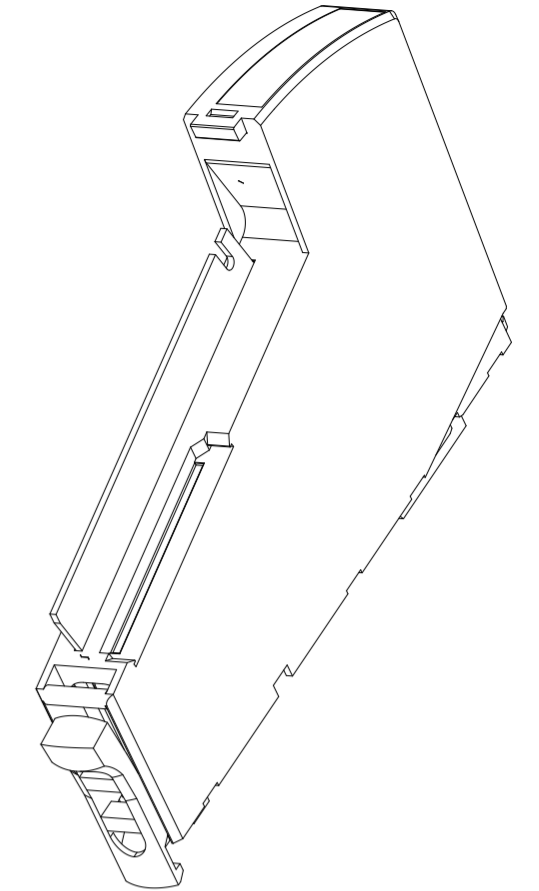
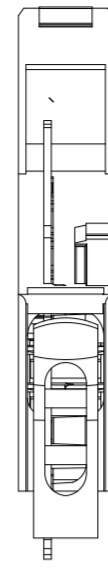

-		20240103	29.04.2024	PD-SUP-MCPD-SUP-MD	Neue Zeichnung. New drawing.		
Index	ECO no.	Date	Editor	Checked			
Scale	1:1	DIN A2		Date	Name	MODEL: DRW 2036535	DRW: 2036536 -
Material			Created	29.04.2024	PD-SUP-MD	Internet Dokument Internet document PSS u2 EM 16p 12.5	
			Checked	29.04.2024	PD-SUP-MD		
			Norm	-	-		
				All dimensions are in mm			
Surface			Unspecified tolerance		Doc.-No.	2036536	Page 1
					Mat.-No.	-	of 1

Refer to protection notice ISO 16016



1 2 3 4 5 6 7 8