



▶ PNOZ s20

PILZ

THE SPIRIT OF SAFETY

Operating Manual-1003324-EN-09

- Safety relays



This document is the original document.

Where unavoidable, for reasons of readability, the masculine form has been selected when formulating this document. We do assure you that all persons are regarded without discrimination and on an equal basis.

All rights to this documentation are reserved by Pilz GmbH & Co. KG. Copies may be made for the user's internal purposes. Suggestions and comments for improving this documentation will be gratefully received.

Pilz®, PIT®, PMI®, PNOZ®, Primo®, PSEN®, PSS®, PVIS®, SafetyBUS p®, SafetyEYE®, SafetyNET p®, the spirit of safety® are registered and protected trademarks of Pilz GmbH & Co. KG in some countries.



SD means Secure Digital

Introduction	5
Validity of documentation	5
Using the documentation	5
Definition of symbols	5
Safety	6
Intended use	6
Safety regulations	7
Safety assessment	7
Use of qualified personnel	7
Warranty and liability	7
Disposal	7
Unit features	8
Safety features	8
Block diagram/terminal configuration	8
Function description	9
Installation	9
Wiring	12
Preparing for operation	13
Application examples	14
Operation	15
Status indicators	16
Faults – Interference	16
Dimensions in mm	20
Technical details	21
Safety characteristic data	24
Supplementary data	24
Operating height in accordance with EN 60664-1	24

Remove plug-in terminals	25
Order reference	25
EC declaration of conformity	25
UKCA-Declaration of Conformity	26

Introduction

Validity of documentation

This documentation is valid for the product PNOZ s20. It is valid until new documentation is published.

This operating manual explains the function and operation, describes the installation and provides guidelines on how to connect the product.

Using the documentation

This document is intended for instruction. Only install and commission the product if you have read and understood this document. The document should be retained for future reference.

Definition of symbols

Information that is particularly important is identified as follows:



DANGER!

This warning must be heeded! It warns of a hazardous situation that poses an immediate threat of serious injury and death and indicates preventive measures that can be taken.



WARNING!

This warning must be heeded! It warns of a hazardous situation that could lead to serious injury and death and indicates preventive measures that can be taken.



CAUTION!

This refers to a hazard that can lead to a less serious or minor injury plus material damage, and also provides information on preventive measures that can be taken.



NOTICE

This describes a situation in which the product or devices could be damaged and also provides information on preventive measures that can be taken. It also highlights areas within the text that are of particular importance.

**INFORMATION**

This gives advice on applications and provides information on special features.

Safety**Intended use**

The contact expansion module PNOZ s20 meets the requirements of EN 60947-5-1 and EN 60204-1. It is used to increase the number of instantaneous safety contacts available on a base unit.

Safety level PL e (Cat. 4)/SIL 3 is only achieved if the safety outputs use 2-channel processing.

The max. achievable safety level depends on the base unit. The expansion module may not exceed this. The safety-related characteristic values stated under [safety-related characteristic data](#) [ 24] can only be achieved if the base unit also exhibits these safety characteristic values.

Only units with a 24 VDC supply voltage may be used as base unit.

**WARNING!****Electric shock!**

If a base unit with a supply voltage greater than 24 VDC is used and voltage is applied, contact with live components could result in serious or even fatal injury from an electric shock.

Only use base units with a 24 VDC supply voltage.

Improper use

The following is deemed improper use in particular:

- ▶ Any component, technical or electrical modification to the product,
- ▶ Use of the product outside the areas described in this operating manual,
- ▶ Use of the product outside the technical details (see chapter entitled [Technical Details](#) [ 21]).

**NOTICE****EMC-compliant electrical installation**

The product is designed for use in an industrial environment. The product may cause interference if installed in other environments. If installed in other environments, measures should be taken to comply with the applicable standards and directives for the respective installation site with regard to interference.

Safety regulations

Safety assessment

Before using a device, a safety assessment in accordance with the Machinery Directive is required.

The product as an individual component fulfils the functional safety requirements in accordance with EN ISO 13849 and EN IEC 62061. However, this does not guarantee the functional safety of the overall plant/machine. To achieve the relevant safety level of the overall plant/machine's required safety functions, each safety function needs to be considered separately.

Use of qualified personnel

The products may only be assembled, installed, programmed, commissioned, operated, decommissioned and maintained by persons who are competent to do so.

A competent person is a qualified and knowledgeable person who, because of their training, experience and current professional activity, has the specialist knowledge required. In order to inspect, assess and handle products, devices, systems, plant and machinery, this person must be familiar with the state of the art and the applicable national, European and international laws, directives and standards.

It is the company's responsibility only to employ personnel who

- ▶ Are familiar with the basic regulations concerning health and safety / accident prevention,
- ▶ Have read and understood the information provided in the section entitled Safety
- ▶ Have a good knowledge of the generic and specialist standards applicable to the specific application.

Warranty and liability

All claims to warranty and liability will be rendered invalid if

- ▶ The product was used contrary to the purpose for which it is intended,
- ▶ Damage can be attributed to not having followed the guidelines in the manual,
- ▶ Operating personnel are not suitably qualified,
- ▶ Any type of modification has been made (e.g. exchanging components on the PCB boards, soldering work etc.).

Disposal

- ▶ In safety-related applications, please comply with the mission time T_M stated in the safety-related characteristic data.
- ▶ When decommissioning, please comply with local regulations regarding the disposal of electronic devices (e.g. Electrical and Electronic Equipment Act).

Unit features

- ▶ Semiconductor outputs:
 - 2 safety outputs instantaneous
 - 1 auxiliary output instantaneous
- ▶ Connection option for expansion modules
- ▶ LED display for:
 - Supply voltage
 - Switch state of safety outputs
 - Input state channel 1/2
 - Fault (see [Faults – Interference](#) [16])
- ▶ Plug-in connection terminals (either spring-loaded terminal or screw terminal)
- ▶ See order reference for unit types

Safety features

The contact expansion module meets the following safety requirements:

- ▶ If the safety outputs use 2-channel processing, the safety function remains effective even in the case of a component failure.
- ▶ The circuit is redundant with built-in self-monitoring.
- ▶ The safety outputs are tested periodically using an off-test.

Block diagram/terminal configuration

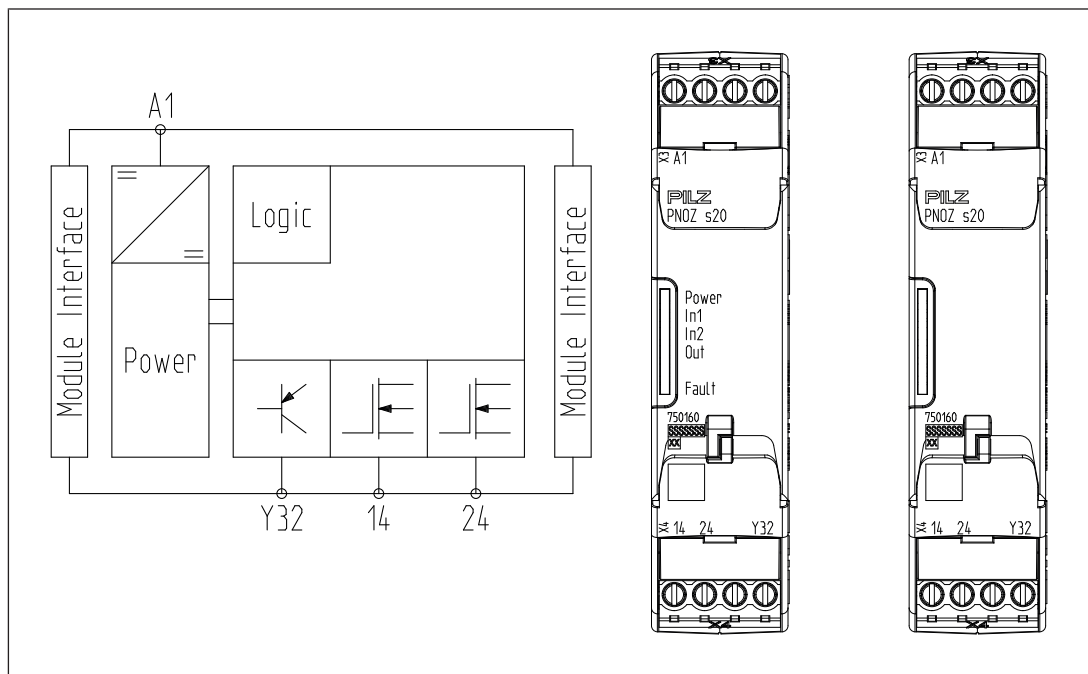

Fig.: Centre: Front view with cover, right: Front view without cover

Function description

The contact expansion module PNOZ s20 also provides safety outputs. It is driven by a base unit PNOZsigma.

Several PNOZ s20 units can be connected to the base unit (see [Installation](#)  9).

Functional procedure after supply voltage has been applied and the base unit's safety contacts are closed:

- ▶ There is a high signal at safety outputs 14 and 24 and auxiliary output Y32.
- ▶ LEDs "IN1", "IN2" and "Out" are lit.

Functional procedure if one or both of the base unit's safety contacts open:

- ▶ There is a low signal at safety outputs 14 and 24 and auxiliary output Y32.
- ▶ LEDs "IN1", "IN2" and "Out" go out.

The safety outputs will not switch back to a high signal until all the base unit's safety contacts are open and then closed again.

Safety outputs are checked via regular off tests.

- ▶ Max. duration of off time during self test, see Technical details
- ▶ Safety outputs are switched off for the duration of the off time during the self test.

The auxiliary output Y32 displays the state of the safety outputs.

Installation

Control cabinet installation

- ▶ Install the safety relay in a control cabinet with a protection type of at least IP54.
- ▶ Use the notch on the rear of the unit to attach it to a DIN rail.
- ▶ Ensure the unit is mounted securely on a vertical DIN rail (35 mm) by using a fixing element (e.g. retaining bracket or an end angle).

Push the unit upwards or downwards before lifting it from the DIN rail.

Connect the base unit and contact expansion module PNOZ s20

- ▶ Remove the plug terminator at the side of the base unit and at the left of the contact expansion module.
- ▶ Connect the base unit and the contact expansion module using the connector supplied, before mounting the units to the DIN rail.

Connect the contact expansion module PNOZ s20 to the contact expansion modules PNOZsigma

- ▶ Connect the contact expansion modules using the connectors supplied.
- ▶ Fit the terminator to the module on the right.
- ▶ Expansion options are described in the following table.

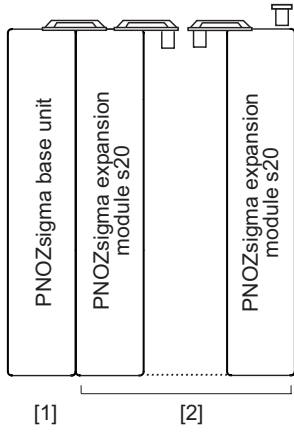
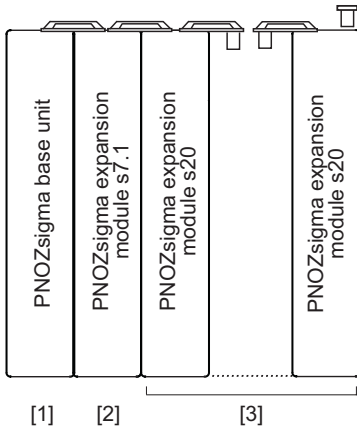
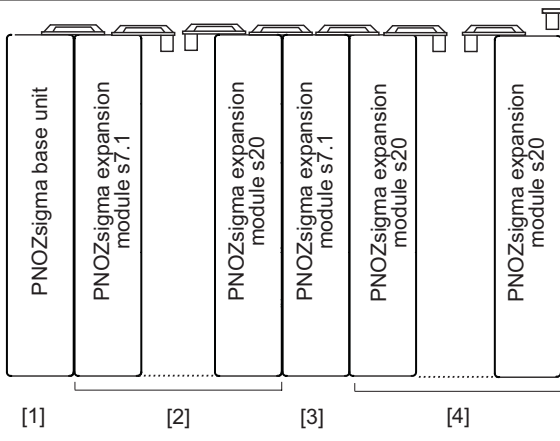
Expansion options	Consider the max. power consumption of all the units used in the application
<p>[1]: Base unit PNOZ s3/s4/s4.1/s5/s6/s6.1</p> <p>[2]: Up to 5 contact expansion modules PNOZ s20 (final block with terminator)</p>	 <p>The diagram shows a PNOZ-sigma base unit labeled [1] followed by a group of expansion modules labeled [2]. The group [2] contains three PNOZ-sigma expansion modules s20, with the final module on the right having a terminator symbol.</p>
<p>[1]: Base unit PNOZsigma</p> <p>[2]: Contact expansion module PNOZ s7.1</p> <p>[3]*: Up to 10 contact expansion modules PNOZ s20 (final block with terminator)</p>	 <p>The diagram shows a PNOZ-sigma base unit labeled [1], followed by a PNOZ-sigma expansion module s7.1 labeled [2], and then a group of expansion modules labeled [3]. The group [3] contains three PNOZ-sigma expansion modules s20, with the final module on the right having a terminator symbol.</p>
<p>[1]: Base unit PNOZsigma</p> <p>[2]: One contact expansion module PNOZ s7.1 and up to 9 contact expansion modules PNOZ s20</p> <p>[3]: Contact expansion module PNOZ s7.1</p> <p>[4]*: Up to 10 contact expansion modules PNOZ s20 (final block with terminator)</p>	 <p>The diagram shows a PNOZ-sigma base unit labeled [1], followed by a PNOZ-sigma expansion module s7.1 labeled [2], then a PNOZ-sigma expansion module s7.1 labeled [3], and finally a group of expansion modules labeled [4]. The group [4] contains three PNOZ-sigma expansion modules s20, with the final module on the right having a terminator symbol.</p>

Expansion options	Consider the max. power consumption of all the units used in the application
<p>[1]: Base unit PNOZsigma</p> <p>[2]: One contact expansion module PNOZ s7.1 and up to 9 contact expansion modules PNOZ s20</p> <p>[3]: Contact expansion module PNOZ s7.1</p> <p>[4]:* Up to 10 contact expansion modules PNOZ s7.2 (final block with terminator)</p>	
<p>[1]: Base unit PNOZsigma</p> <p>[2]: One contact expansion module PNOZ s7.1 and up to 9 contact expansion modules PNOZ s7.2</p> <p>[3]: Contact expansion module PNOZ s7.1</p> <p>[4]*: Up to 10 contact expansion modules PNOZ s20 (final block with terminator)</p>	

*) Alternatively, one of the following units can be used as the final expansion block:

- ▶ PNOZ s7
- ▶ PNOZ s8
- ▶ PNOZ s9
- ▶ PNOZ s10
- ▶ PNOZ s11

These units sometimes require more power than the units combined in the table. If the maximum power consumption of all expansion modules is exceeded (see the technical details of the respective devices), you will need to reduce the number of connected PNOZ s20 or PNOZ s7.2 units.

Example:

Use of PNOZ s10 with a power consumption of 3 W

The max. number of expansion modules PNOZ s20 or PNOZ s7.2 is reduced by 2:

- ▶ 1 unit, in order to comply with the max. power consumption and
- ▶ 1 unit, which is replaced by PNOZ s10

Wiring

Please note:

- ▶ Information given in the "[Technical details \[📖 21\]](#)" must be followed.



WARNING!

Electric shock!

If a base unit with a supply voltage greater than 24 VDC is used and voltage is applied, contact with live components could result in serious or even fatal injury from an electric shock.

Only use base units with a 24 VDC supply voltage.

- ▶ Outputs 14-24 are safety outputs; semiconductor output Y32 is an auxiliary output (e.g. for display).



WARNING!

Loss of safety function due to the use of semiconductor output Y32 as a safety output!

The semiconductor output Y32 is an auxiliary output (e.g. for display). If it is used for a safety circuit, serious injuries and death may result.

Do **not** use semiconductor output Y32 for safety circuits.

- ▶ Use copper wiring with a temperature stability of 75 °C.
- ▶ To prevent EMC interferences (particularly common-mode interferences) the measures described in EN 60204-1 must be executed. This includes the separate routing of cables of the control circuits (input, start and feedback loop) from other cables for energy transmission or the shielding of cables, for example.
- ▶ Adequate protection circuit must be provided on all output contacts with capacitive and inductive loads.
- ▶ The power supply must comply with the regulations for extra low voltages with protective electrical separation (SELV, PELV) in accordance with VDE 0100, Part 410.

Preparing for operation

Supply voltage/input circuit/ feedback loop	AC	DC
Contact expansion module PNOZ s20	/	

Connect the N/C contacts from external contactors to the feedback loop on the base unit.



NOTICE

If you supply the contact expansion module PNOZ s20 via a separate power supply:

- Connect L- on the power supply to A2 on the base unit or
- Connect L- on the power supply to B2 on the expansion module PNOZ s7.1

Safety output	Single-channel operation	Dual-channel operation

With dual-channel operation, always use both safety outputs for a safety function.

Application examples

Combined with PNOZ s4

- ▶ Emergency stop
- ▶ Dual-channel
- ▶ with detection of shorts across contacts
- ▶ monitored start
- ▶ falling edge with feedback loop monitoring

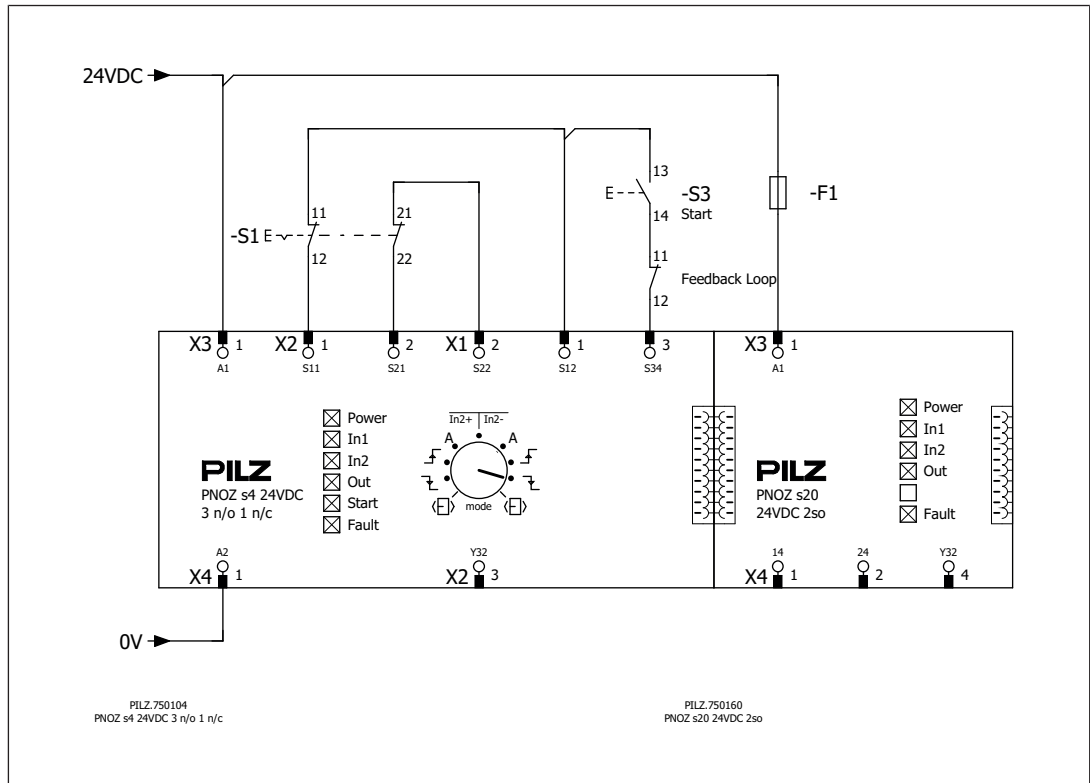

Combination with PNOZ s7.1 and PNOZ s4

- ▶ Emergency stop
- ▶ Dual-channel
- ▶ with detection of shorts across contacts
- ▶ monitored start
- ▶ falling edge with feedback loop monitoring

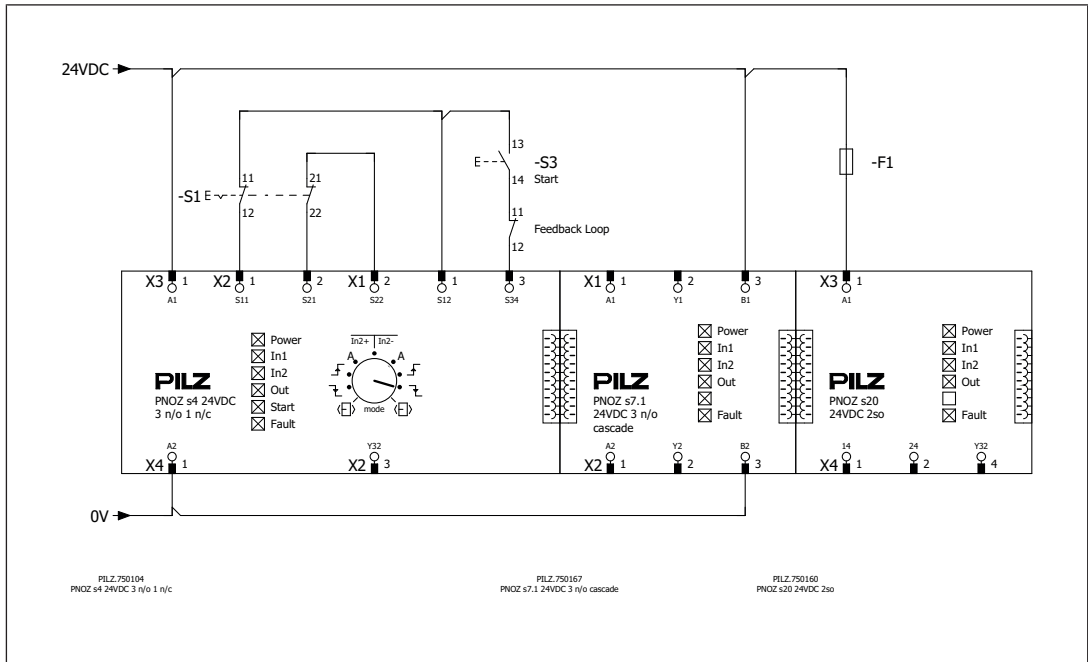

Operation



NOTICE

The safety functions should be checked after initial commissioning and each time the plant/machine is changed. The safety functions may only be checked by qualified personnel.



INFORMATION

The safety outputs are constantly checked via test pulses. This may generate a humming noise on the connected contactors, which does not affect the function. The test pulses also mean that, when measured with a multi-meter, the voltage at the safety outputs is displayed to be less than it actually is.

LEDs indicate the status and errors during operation:

 LED on

Status indicators

 **In1**
Input circuit 1 activated and safety outputs on the base unit closed.

 **In2**
Input circuit 2 activated and safety outputs on the base unit closed.

 **In1, In2, Out**
Safety outputs 14 and 24 have a high signal.

 **Fault**
See [Faults – Interference](#) [ 16]

Faults – Interference

If an error occurs on the contact expansion module PNOZ s20, the base unit can no longer be activated.



NOTICE

Malfunction of the contacts on the base unit

If the contacts on the base unit have welded, reactivation of the PNOZ s20 will not be possible after the input circuit has opened.

Fault conditions are indicated by flashing the LEDs. Some faults are displayed through periodic flashing, while with other faults it is possible to establish an error code through the number of flashes. These faults are always indicated by three short flashes of the Fault LED. After a longer pause, the LED will then flash at one second intervals. The number of LED flashes corresponds to a digit in the error code.

The error code can consist of up to 4 digits. The digits are separated by a longer period without flashing. The entire sequence is constantly repeated.



INFORMATION

Leading zeros are not downloaded. Error code 0: 16 flashes

LED	Error	Remedy
LEDs unlit	Supply voltage is missing, too low, wrongly connected	Connect supply voltage: A1 / +24 VDC Permitted voltage range: 20.4 ... 26.4 VDC
POWER flashes briefly on start-up	Initialisation phase	No remedy required
POWER flashes constantly	Supply voltage is outside the permitted voltage range	Check the power supply and change if necessary

LED	Error	Remedy
Fault flashes	Internal or external fault	Switch U _B off and on, change unit
Fault flashes a code	See error coding table	

Examples

Error code 1, 3:

The Fault LED flashes

- ▶ 3 times, short
- ▶ Pause
- ▶ Once for one second
- ▶ Pause
- ▶ 3 times, for one second each
- ▶ 3 times, short

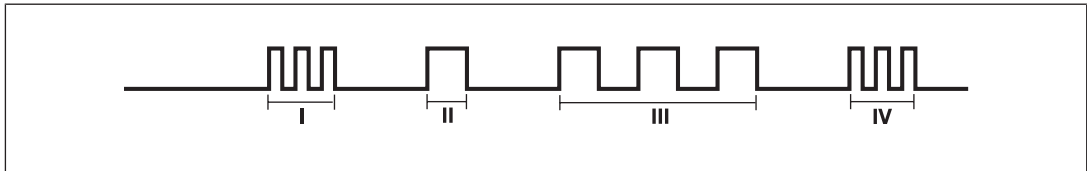

Error code 1:

The Fault LED flashes

- ▶ 3 times, short
- ▶ Pause
- ▶ Once for one second
- ▶ 3 times, short

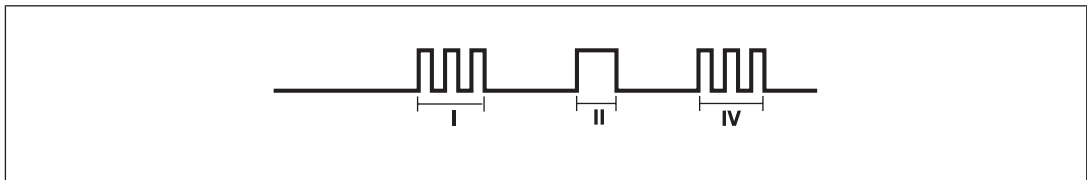

Error code 1, 0:

The Fault LED flashes

- ▶ 3 times, short
- ▶ Pause
- ▶ Once for one second
- ▶ Pause
- ▶ 16 times, for one second each
- ▶ 3 times, short



I	Code for error message
II	Code for 1st digit
III	Code for 2nd digit
IV	Code for error message repeated

The table below shows the relationship between the number of flashes and the error code. The key to the error codes is described in the Error coding table.

Number of flashes	1	2	3	4	5	6	7	8	9	10	11	12	13	14	15	16
Decimal error code	1	2	3	4	5	6	7	8	9	10	11	12	13	14	15	0

Error coding



INFORMATION

The table below describes the error codes for faults that users can rectify themselves. If error codes are not listed, that means they are internal faults.

In the case of an internal fault, switch the supply voltage off and then on again. If nothing helps, change the unit.

Decimal error code	Number of flashes	Description	Remedy
4	3x short – 4x long – 3x short	In the initialisation phase, short circuit between the safety outputs and +24 VDC	Rectify wiring error at terminals 14, 24
5	3x short – 5x long – 3x short		
6	3x short – 6x long – 3x short		
9	3x short – 9x long – 3x short		
10	3x short – 10x long – 3x short	During operation, short circuit between safety outputs and +24 VDC	Rectify wiring error at terminals 14, 24
12	3x short – 12x long – 3x short		
14	3x short – 14x long – 3x short		
15	3x short – 15x long – 3x short		
1, 0	3x short – 1x long – 16x long – 3x short		
1, 1	3x short – 1x long – 1x long – 3x short		
1, 9	3x short – 1x long – 9x long – 3x short		
10.1	3x short – 10x long – 1x long – 3x short		
14.5	3x short – 14x long – 5x long – 3x short		
11	3x short – 11x long – 3x short		
1, 2	3x short – 1x long – 2x long – 3x short	During operation, short circuit between the safety outputs and 0 VDC or $U_B < 20.4$ VDC	Rectify wiring error at terminals 14, 24; comply with the supply voltage range 20.4 ... 26.4 VDC
1, 3	3x short – 1x long – 3x long – 3x short		
1, 12	3x short – 1x long – 12x long – 3x short		
1, 13	3x short – 1x long – 13x long – 3x short		
5, 10	3x short – 5x long – 10x long – 3x short	$U_B < 20.4$ VDC	Comply with the supply voltage range 20.4 ... 26.4 VDC

Decimal error code	Number of flashes	Description	Remedy
8, 2	3x short – 8x long – 2x long – 3x short	Supply interrupted, possibly caused by a short to earth. Short circuit of safety outputs 14 or 24 to 0 VDC.	Rectify wiring error at terminal A1 or check supply voltage. Rectify short circuit. If the remedy does not help the user – Send unit to Pilz
8, 3	3x short – 8x long – 3x long – 3x short		
14, 13	3x short – 14x long – 13x long – 3x short		
2, 0, 0	3x short – 2x long – 16x long – 16x long – 3x short	$U_B < 20.4$ VDC	Comply with the supply voltage range 20.4 ... 26.4 VDC
2, 0, 1	3x short – 2x long – 16x long – 1x long – 3x short		
2, 0, 2	3x short – 2x long – 16x long – 2x long – 3x short	In the initialisation phase, short circuit between the safety outputs and +24 VDC	Rectify wiring error at terminals 14, 24
2, 0, 3	3x short – 2x long – 16x long – 3x long – 3x short	$U_B < 20.4$ VDC	Comply with the supply voltage range 20.4 ... 26.4 VDC

Dimensions in mm

* with spring-loaded terminals

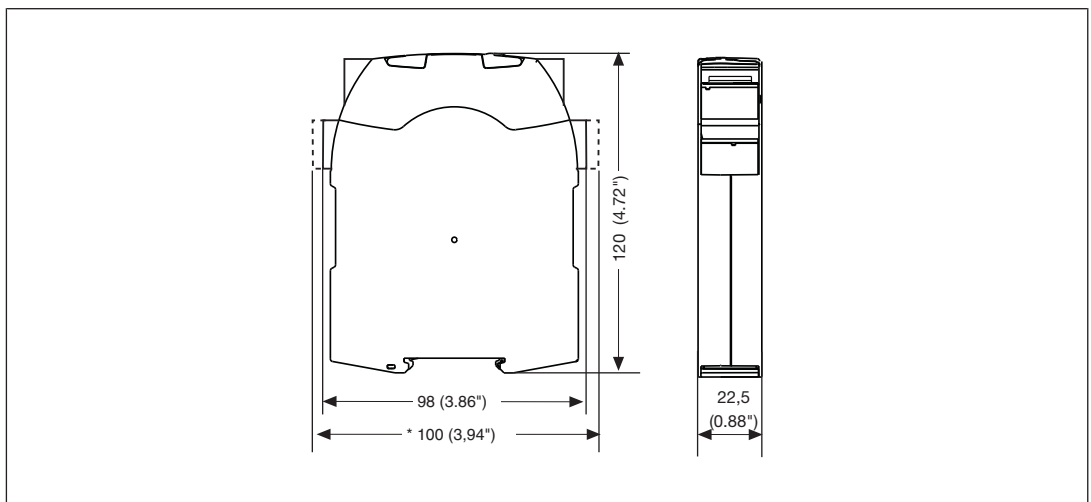

Technical details

Where standards are undated, the 2022-09 valid editions apply.

General	750160	751160
Certifications	CCC, CE, EAC, TÜV, UKCA, cULus Listed	CCC, CE, EAC, TÜV, UKCA, cULus Listed
Electrical data	750160	751160
Supply voltage		
for	Module supply	Module supply
Voltage	24 V	24 V
Kind	DC	DC
Voltage tolerance	-15 %/+10 %	-15 %/+10 %
Output of external power supply (DC)	95 W	95 W
Output of external power supply (DC) at no load	1,6 W	1,6 W
Residual ripple DC	20 %	20 %
Duty cycle	100 %	100 %
External unit fuse protection F1 max.	4 A, circuit breaker 24 VAC/DC, characteristic B	4 A, circuit breaker 24 VAC/DC, characteristic B
Semiconductor outputs	750160	751160
Overall performance ext. Load, semiconductor	93 W	93 W
Number of safety outputs		
Instantaneous	2	2
Number of auxiliary outputs	1	1
Residual current at "0" signal	2 mA	2 mA
Max. internal voltage drop	1 V	1 V
Max. duration of off time during self test	600 µs	600 µs
Switching capability, 2 safety outputs under load		
Current	1,5 A	1,5 A
Power	40 W	40 W
Switching capability, 1 safety output under load		
Current	2 A	2 A
Power	50 W	50 W
Switching capability auxiliary outputs		
Current	0,5 A	0,5 A
Power	13 W	13 W
Conditional rated short circuit current	100 A	100 A
Lowest operating current	3 mA	3 mA

Semiconductor outputs	750160	751160
Utilisation category in accordance with EN 60947-1	DC-12	DC-12
Max. cable capacitance at the outputs without load	2 nF	2 nF
Times	750160	751160
Switch-on delay		
Max. switch-on delay after power on	4 s	4 s
with automatic start typ.	60 ms	60 ms
with automatic start max.	210 ms	210 ms
Recovery time at max. switching frequency 1/s		
after E-STOP	50 ms	50 ms
after power failure	50 ms	50 ms
Response time t_r semiconductor outputs		
typ.	25 ms	25 ms
max.	35 ms	35 ms
Environmental data	750160	751160
Climatic suitability	EN 60068-2-78	EN 60068-2-78
Ambient temperature		
Temperature range	-10 - 55 °C	-10 - 55 °C
Storage temperature		
Temperature range	-40 - 85 °C	-40 - 85 °C
Climatic suitability		
Humidity	93 % r. h. at 40 °C	93 % r. h. at 40 °C
Condensation during operation	Not permitted	Not permitted
EMC	EN 60947-5-1, EN 61000-6-2, EN 61000-6-4, EN 61326-3-1	EN 60947-5-1, EN 61000-6-2, EN 61000-6-4, EN 61326-3-1
Vibration		
in accordance with the standard	EN 60068-2-6	EN 60068-2-6
Frequency	10 - 55 Hz	10 - 55 Hz
Amplitude	0,35 mm	0,35 mm
Airgap creepage		
in accordance with the standard	EN 60947-1	EN 60947-1
Overvoltage category	III	III
Pollution degree	2	2
Rated insulation voltage	30 V	30 V
Rated impulse withstand voltage	0,8 kV	0,8 kV
Protection type		
Housing	IP40	IP40
Terminals	IP20	IP20
Mounting area (e.g. control cabinet)	IP54	IP54
Mechanical data	750160	751160
Mounting position	Any	Any

Mechanical data	750160	751160
Material		
Bottom	PC	PC
Front	PC	PC
Top	PC	PC
Connection type	Screw terminal	Spring-loaded terminal
Mounting type	plug-in	plug-in
Conductor cross section with screw terminals		
1 core flexible	0,25 - 2,5 mm², 24 - 12 AWG	–
2 core with the same cross section, flexible with crimp connectors, no plastic sleeve	0,25 - 1 mm², 24 - 16 AWG	–
2 core with the same cross section, flexible without crimp connectors or with TWIN crimp connectors	0,2 - 1,5 mm², 24 - 16 AWG	–
Torque setting with screw terminals	0,5 Nm	–
Stripping length with screw terminals	7 mm	–
Conductor cross section with spring-loaded terminals: Flexible with/without crimp connector	–	0,2 - 2,5 mm², 24 - 12 AWG
Spring-loaded terminals: Terminal points per connection	–	2
Stripping length with spring-loaded terminals	–	9 mm
Dimensions		
Height	98 mm	100 mm
Width	22,5 mm	22,5 mm
Depth	120 mm	120 mm
Weight	120 g	120 g

Safety characteristic data



NOTICE

You must comply with the safety characteristic data in order to achieve the required safety level for your plant/machine.

Operating mode	EN ISO 13849-1: 2015 PL	EN ISO 13849-1: 2015 Category	EN IEC 62061 SIL CL/max. SIL	EN IEC 62061 61508 PFH [1/h]	EN/IEC 61511 61508 SIL	EN/IEC 61511 61508 PFD	EN ISO 13849-1: 2015 T _M [year]
1-channel	PL d	Cat. 2	SIL 2	1,32E-08	SIL 2	1,17E-03	20
2-channel	PL e	Cat. 4	SIL 3	2,03E-09	SIL 3	1,85E-04	20

Explanatory notes for the safety-related characteristic data:

- ▶ T_M is the maximum mission time in accordance with EN ISO 13849-1. The value also applies as the retest interval in accordance with EN/IEC 61508-6 and EN/IEC 61511 and as the proof test interval and mission time in accordance with EN IEC 62061

All the units used within a safety function must be considered when calculating the safety characteristic data.



INFORMATION

A safety function's SIL/PL values are **not** identical to the SIL/PL values of the products used and may differ from these.

Supplementary data

Operating height in accordance with EN 60664-1

The values stated in the technical details apply to the use of the product in operating heights up to max. 2000 m above sea level. When used in greater heights, constraints have to be taken into account:

- ▶ Permitted maximum operating height 5000 m
- ▶ From an operating height of 2000 m the max. permitted ambient temperature is reduced by 0.5 °C/100 m

Operating height	Permitted ambient temperature
3000 m	50 °C
4000 m	45 °C
5000 m	40 °C

Remove plug-in terminals

Procedure

► Insert a suitable screwdriver into the housing recess behind the terminal.

Do **not** remove the terminals by pulling the cables!

► Lever the terminal out.

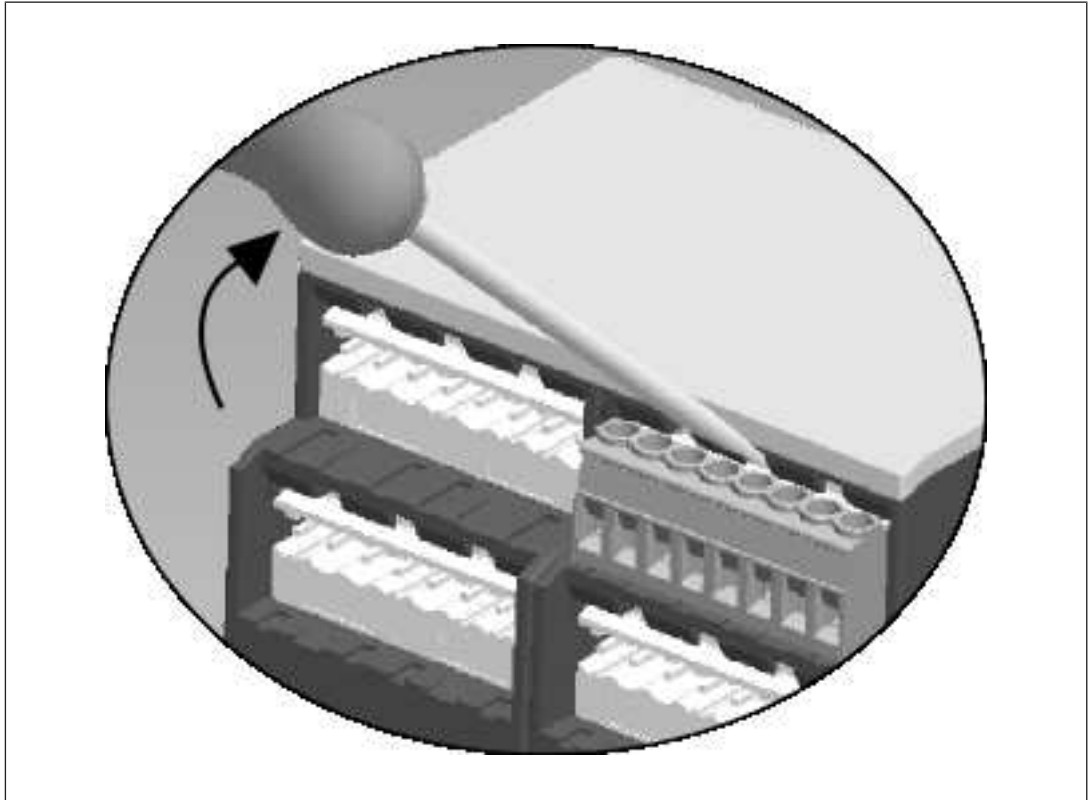

Order reference

Product type	Features	Connection type	Order no.
PNOZ s20	24 V DC	Screw terminals	750160
PNOZ s20 C	24 V DC	Spring-loaded terminals	751160

EC declaration of conformity

This product/these products meet the requirements of the directive 2006/42/EC on machinery of the European Parliament and of the Council. The complete EC Declaration of Conformity is available on the Internet at www.pilz.com/downloads.

Representative: Pilz GmbH & Co. KG, Felix-Wankel-Str. 2, 73760 Ostfildern, Germany

UKCA-Declaration of Conformity

This product(s) complies with following UK legislation: Supply of Machinery (Safety) Regulation 2008.

The complete UKCA Declaration of Conformity is available on the Internet at www.pilz.com/downloads.

Representative: Pilz Automation Technology, Pilz House, Little Colliers Field, Corby, Northamptonshire, NN18 8TJ United Kingdom, eMail: mail@pilz.co.uk

Support

Technical support is available from Pilz round the clock.

Americas

Brazil

+55 11 97569-2804

Canada

+1 888 315 7459

Mexico

+52 55 5572 1300

USA (toll-free)

+1 877-PILZUSA (745-9872)

Asia

China

+86 400-088-3566

Japan

+81 45 471-2281

South Korea

+82 31 778 3300

Australia and Oceania

Australia

+61 3 95600621

New Zealand

+64 9 6345350

Europe

Austria

+43 1 7986263-444

Belgium, Luxembourg

+32 9 3217570

France

+33 3 88104003

Germany

+49 711 3409-444

Ireland

+353 21 4804983

Italy, Malta

+39 0362 1826711

Scandinavia

+45 74436332

Spain

+34 938497433

Switzerland

+41 62 88979-32

The Netherlands

+31 347 320477

Türkiye

+90 216 5775552

United Kingdom

+44 1536 462203

You can reach our international hotline on:

+49 711 3409-222

support@pilz.com

Pilz develops environmentally-friendly products using ecological materials and energy-saving technologies. Offices and production facilities are ecologically designed, environmentally-aware and energy-saving. So Pilz offers sustainability, plus the security of using energy-efficient products and environmentally-friendly solutions.



We are represented internationally. Please refer to our homepage www.pilz.com for further details or contact our headquarters.

Headquarters: Pilz GmbH & Co. KG, Felix-Wankel-Straße 2, 73760 Ostfildern, Germany
Telephone: +49 711 3409-0, E-Mail: info@pilz.com, Internet: www.pilz.com

PILZ
THE SPIRIT OF SAFETY

CECE[®], CHRE[®], CMSE[®], INDUSTRIAL P[®], Leansafe[®], Myzei[®], PAS4000[®], PASscal[®], PASconfig[®], Pilz[®], PIT[®], PMSprimo[®], PMSprotego[®], PMCiendo[®], PMD[®], PMI[®], PNOZ[®], Primo[®], PSEN[®], PSS[®], PVS[®], SafetyBUS p[®], SafetyNET p[®], THE SPIRIT OF SAFETY[®] are registered and protected trademarks of Pilz GmbH & Co. KG in some countries. We would point out that product features may vary from the details stated in this document, depending on the status at the time of publication and the scope of the equipment. We accept no responsibility for the validity, accuracy and entirety of the text and graphics presented in this information. Please contact our Technical Support if you have any questions.

1003324-EN-09, 2025-02 Printed in Germany
© Pilz GmbH & Co. KG, 2019