



## ► PNOZ m EF PDP Link

**PILZ**  
THE SPIRIT OF SAFETY

Operating Manual-1003019-EN-09

- Configurable, safe small controllers PNOZmulti 2



This document is a translation of the original document.

Where unavoidable, for reasons of readability, the masculine form has been selected when formulating this document. We do assure you that all persons are regarded without discrimination and on an equal basis.

All rights to this documentation are reserved by Pilz GmbH & Co. KG. Copies may be made for the user's internal purposes. Suggestions and comments for improving this documentation will be gratefully received.

CECE®, CHRE®, CMSE®, INDUSTRIAL PI®, Leansafe®, MYZEL®, PAS4000®, PAS-cal®, PASconfig®, Pilz®, PIT®, PMCprimo®, PMCprotego®, PM Ctendo®, PMD®, PMI®, PNOZ®, Primo®, PSEN®, PSS®, PVIS®, SafetyBUS p®, SafetyEYE®, SafetyNET p®, THE SPIRIT OF SAFETY® are registered and protected trademarks of Pilz GmbH & Co. KG in some countries.



SD means Secure Digital

<b>1</b>	<b>Introduction</b> .....	<b>5</b>
1.1	Validity of documentation .....	5
1.2	Using the documentation .....	5
1.3	Definition of symbols .....	5
<b>2</b>	<b>Overview</b> .....	<b>7</b>
2.1	Scope of supply .....	7
2.2	Product features .....	7
2.3	Front view .....	8
<b>3</b>	<b>Safety and Security</b> .....	<b>9</b>
3.1	Intended use .....	9
3.1.1	Product .....	9
3.1.2	Application ranges .....	9
3.1.3	Application conditions .....	10
3.1.4	Use of qualified personnel .....	10
3.1.5	Prerequisites for operation .....	10
3.1.6	Specific measures for intended use .....	10
3.1.7	Improper use .....	11
3.1.8	Security environment .....	11
3.1.9	Third-party manufacturer licence information .....	11
3.2	System requirements .....	11
3.3	Safety regulations .....	11
3.3.1	Applicable documentation .....	11
3.3.2	Safety assessment .....	12
3.3.3	Warranty and liability .....	12
3.3.4	For your safety .....	12
3.4	General security information .....	12
3.5	Security measures .....	13
3.5.1	Required security measures .....	13
<b>4</b>	<b>Function description</b> .....	<b>14</b>
4.1	Integrated protection mechanisms .....	14
4.2	Functions .....	14
4.3	System reaction time .....	15
4.4	Block diagram .....	15
<b>5</b>	<b>Installation</b> .....	<b>16</b>
5.1	General installation guidelines .....	16
5.2	Dimensions in mm .....	16
5.3	Connect the base unit and expansion modules .....	17
<b>6</b>	<b>Commissioning</b> .....	<b>18</b>
6.1	Wiring .....	18
6.1.1	Insulation voltage test .....	19
6.2	Connection .....	19
6.3	Download modified project to the PNOZmulti safety system .....	19
6.4	Series connection of 4 decentralised modules .....	20

6.5	Voltage drop.....	20
6.5.1	Guidelines for various cable types.....	20
6.5.2	Calculation example.....	21
<b>7</b>	<b>Operation</b> .....	<b>22</b>
7.1	LED indicators.....	22
7.2	Fault detection.....	22
<b>8</b>	<b>Maintenance and testing</b> .....	<b>24</b>
<b>9</b>	<b>Decommissioning</b> .....	<b>25</b>
9.1	Disposal .....	25
<b>10</b>	<b>Technical details</b> .....	<b>26</b>
10.1	Safety characteristic data.....	28
<b>11</b>	<b>Order reference</b> .....	<b>29</b>
11.1	Product.....	29
11.2	Accessories.....	29
11.2.1	Terminals .....	29
11.2.2	Connector plug.....	29
11.2.3	By the metre.....	29
11.2.4	Cable.....	30
11.2.5	Adapter.....	31
11.2.6	Plug-in connector .....	31
<b>12</b>	<b>EU/EC declaration of conformity</b> .....	<b>33</b>
<b>13</b>	<b>UKCA-Declaration of Conformity</b> .....	<b>34</b>

# 1 Introduction

## 1.1 Validity of documentation

This documentation is valid for the product PNOZ m EF PDP Link. It is valid until new documentation is published.

This operating manual explains the function and operation, describes the installation and provides guidelines on how to connect the product.

## 1.2 Using the documentation

This document is intended for instruction. Only install and commission the product if you have read and understood this document. The document should be retained for future reference.

## 1.3 Definition of symbols

Information that is particularly important is identified as follows:



### **DANGER!**

This warning must be heeded! It warns of a hazardous situation that poses an immediate threat of serious injury and death and indicates preventive measures that can be taken.



### **WARNING!**

This warning must be heeded! It warns of a hazardous situation that could lead to serious injury and death and indicates preventive measures that can be taken.



### **CAUTION!**

This refers to a hazard that can lead to a less serious or minor injury plus material damage, and also provides information on preventive measures that can be taken.



### **NOTICE**

This describes a situation in which the product or devices could be damaged and also provides information on preventive measures that can be taken. It also highlights areas within the text that are of particular importance.



**INFORMATION**

This gives advice on applications and provides information on special features.

## 2 Overview

### 2.1 Scope of supply

- ▶ Expansion module PNOZ m EF PDP Link
- ▶ Jumper

### 2.2 Product features

Application of the product PNOZ m EF PDP Link:

Link module to safely connect decentralised input/output modules to a configurable control system PNOZmulti 2

The product has the following features:

- ▶ Can be configured in the PNOZmulti Configurator
- ▶ Max. 4 PNOZ m EF PDP Link can be connected to the base unit
- ▶ Max. 4 decentralised modules can be connected to the link module PNOZ m EF PDP Link
- ▶ LEDs for
  - Operating state
  - Error
  - Connection status
- ▶ Plug-in connection terminals:  
Either spring-loaded terminal or screw terminal available as an accessory (see Order references for accessories).

## 2.3 Front view

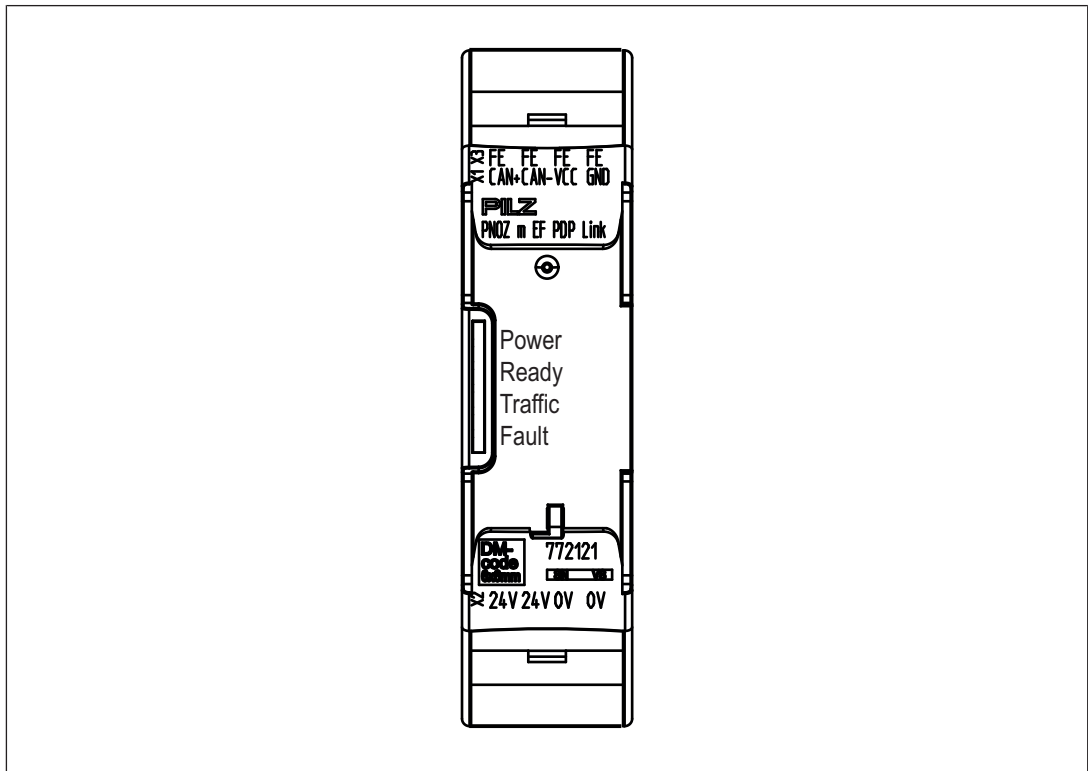

Legend:

- ▶ 0 V, 24 V:  
Supply connections
- ▶ CAN+, CAN-, VCC, GND:  
Connection for decentralised modules
- ▶ FE:  
Functional earth

## 3 Safety and Security

### 3.1 Intended use

#### 3.1.1 Product

The expansion module is used to connect decentralised input/output modules to a configurable control system PNOZmulti 2 .

The expansion module may only be connected to a base unit from the configurable system PNOZmulti 2 (please refer to the document "PNOZmulti System Expansion" for details of the base units that can be connected).

#### 3.1.2 Application ranges

The configurable system PNOZmulti 2 is used for the safety-related interruption of safety circuits and is designed for use in:

- ▶ Emergency stop equipment
- ▶ Safety circuits in accordance with VDE 0113 Part 1 and EN 60204-1

##### Lifts Directive

The product can be used as a PESSRAL (programmable electronic system in safety-related applications for lifts) in accordance with the Lifts Directive 2014/33/EU. It meets the requirements for passenger and goods lifts in accordance with EN 81-1/2, EN 81-20, EN 81-22 and EN 81-50, as well as the requirements for escalators and moving walks in accordance with EN 115-1.

The safety controller should be installed in a protected environment that meets at least the requirements of pollution degree 2.

Example: a protected indoor space or control cabinet with a protection type of IP54 and appropriate climate control.

##### Use in furnaces

The product PNOZ m EF PDP Link can be used in furnaces in accordance with EN 298. Please note:

- ▶ To protect against transient power failures (EN 61000-4-11) the AC power supply used for the system must meet a secondary buffering for 20 ms.
- ▶ If the system is used in a DC network, sufficient surge voltage protection must be ensured.

To limit surge voltage, use external protection elements with the following minimum properties:

Installation class 4 / test level 4 in accordance with EN 61000-4-5 (4kV 1.2/50 µs)

### 3.1.3 Application conditions



#### NOTICE

##### EMC-compliant electrical installation

The product is designed for use in an industrial environment. The product may cause interference if installed in other environments. If installed in other environments, measures should be taken to comply with the applicable standards and directives for the respective installation site with regard to interference.



#### CAUTION!

Inputs and outputs for standard functions must not be used for safety-related applications.

### 3.1.4 Use of qualified personnel

The products may only be assembled, installed, programmed, commissioned, operated, de-commissioned and maintained by persons who are competent to do so.

A competent person is a qualified and knowledgeable person who, because of their training, experience and current professional activity, has the specialist knowledge required. In order to inspect, assess and handle products, devices, systems, plant and machinery, this person must be familiar with the state of the art and the applicable national, European and international laws, directives and standards.

It is the company's responsibility only to employ personnel who

- ▶ Are familiar with the basic regulations concerning health and safety / accident prevention,
- ▶ Have read and understood the section on "Safety" in this description and
- ▶ Have a good knowledge of the generic and specialist standards applicable to the specific application.

### 3.1.5 Prerequisites for operation

This document is intended for instruction. Only install and commission the product if you have read and understood this document.

Only approved accessories and approved consumables may be used.

### 3.1.6 Specific measures for intended use



#### NOTICE

The safety functions should be checked after initial commissioning and each time the plant/machine is changed. The safety functions may only be checked by qualified personnel.

### 3.1.7 Improper use

The following is deemed improper use in particular:

- ▶ Any component, technical or electrical modification to the product,
- ▶ Use of the product outside the areas described in this operating manual,
- ▶ Use of the product outside the technical details (see chapter entitled [Technical Details](#) [ 26]).

### 3.1.8 Security environment

The product must be located in an environment in which physical access to the product and data cables is adequately prevented by mechanical and organisational measures. For example, this can be achieved by installing the product in a lockable control cabinet or in a sufficiently secure machine enclosure.

If the product is operated outside a machine enclosure or control cabinet or if wired communication connections run outside, organisational measures must be taken to ensure that only authorised personnel have physical access to the product. This can be achieved, for example, by controlling access to the workshop.

Further information on Security can be found under General security information and Security measures.

### 3.1.9 Third-party manufacturer licence information

This product includes Open Source software with various licenses.

Further information is available in the document "Third-party manufacturer licence information PNOZ m EF PDP Link" (document number 1006475) at [www.pilz.com](http://www.pilz.com).

## 3.2 System requirements

Please refer to the "Product Modifications PNOZmulti" document in the "Version overview" section for details of which versions of the base unit and PNOZmulti Configurator can be used for this product.

## 3.3 Safety regulations

### 3.3.1 Applicable documentation

This document includes only part of the information required for the use of the product. To understand and correctly use the product you must read further documents.

Please read the following documents:

- ▶ "PNOZmulti Safety Manual" (document number 21103)
- ▶ "PNOZmulti Installation Manual" (document number 1002265)
- ▶ The advanced functions of the device are described in the online help for the PNOZmulti Configurator, in the document "PNOZmulti 2 Communication Interfaces" and in the document "PNOZmulti Special Applications". Only use these functions once you have read and understood the documentation.

- ▶ The connectable PNOZmulti base units, the max. number of connectable modules and the system reaction times can be taken from the document "PNOZmulti System Expansion" (document number 1002217).

### 3.3.2 Safety assessment

Before using the product, a risk assessment is required in accordance with the Machinery Regulation.

Connecting additional units may result in further risks. Take the necessary measures to protect against corruption.

The product as an individual component fulfils the functional safety requirements in accordance with EN/IEC 61508, EN ISO 13849-1/2 and EN IEC 62061. However, this does not guarantee the functional safety of the overall plant/machine. To achieve the relevant safety level of the overall plant/machine's required safety functions, each safety function needs to be considered separately.

It is the responsibility of the user/operator to carry out a risk assessment for their application, in which they consider the impact of assumed errors in the wiring and take appropriate measures to control or avoid these errors.

### 3.3.3 Warranty and liability

All claims to warranty and liability will be rendered invalid if

- ▶ The product was used contrary to the purpose for which it is intended,
- ▶ Damage can be attributed to not having followed the guidelines in the manual,
- ▶ Operating personnel are not suitably qualified,
- ▶ Any type of modification has been made (e.g. exchanging components on the PCB boards, soldering work etc.).

### 3.3.4 For your safety

The unit meets all the necessary conditions for safe operation. However, you should always ensure that the following safety requirements are met:

- ▶ This operating manual only describes the basic functions of the unit. The expanded functions are described in the PNOZmulti Configurator's online help. Only use these functions once you have read and understood the documentations.
- ▶ Do not open the housing or make any unauthorised modifications.
- ▶ Please make sure you shut down the supply voltage when performing maintenance work (e.g. exchanging contactors).

## 3.4 General security information

To protect plants, systems, machines and networks against cyberthreats it is necessary to implement (and continuously maintain) an overall Industrial Security concept that is state of the art.

Carry out a risk assessment in accordance with VDI/VDE 2182 or IEC 62443-3-2 and plan the security measures with care.

If you have any questions about implementation, please contact technical support at [support@pilz.com](mailto:support@pilz.com).

You can reach the Pilz Product Security Incident Response Team (PSIRT) at <https://www.pilz.com/psirt>.

With regard to a Pilz product, this is where you can:

- ▶ Report security vulnerabilities and security incidents
- ▶ Ask questions about security vulnerabilities and security incidents
- ▶ View Security Advisories

## **3.5 Security measures**

### **3.5.1 Required security measures**

- ▶ The product is not protected from physical manipulation or from reading of memory contents during physical access. Use appropriate measures to ensure that there is no physical access by unauthorised persons. You should also use security seals so that you can detect any manipulation of the product or interfaces. Installation inside a lockable control cabinet is recommended as a minimum measure.

## 4 Function description

### 4.1 Integrated protection mechanisms

The relay meets the following safety requirements:

- ▶ The circuit is redundant with built-in self-monitoring.
- ▶ The safety device remains effective in the case of a component failure.

### 4.2 Functions

The link module PNOZ m EF PDP Link is used to safely transfer the input information from decentralised modules to the control system PNOZmulti 2.

The function of the inputs and outputs on the control system depends on the safety circuit created using the PNOZmulti Configurator. A chip card is used to download the safety circuit to the base unit. The base unit has 2 microcontrollers that monitor each other. They evaluate the input circuits on the base unit and expansion modules and switch the outputs on the base unit and expansion modules accordingly.

The LEDs on the base unit and expansion modules indicate the status of the configurable control system PNOZmulti.

The online help on the PNOZmulti Configurator contains descriptions of the operating modes and all the functions of the control system, plus connection examples.

#### **Data exchange:**

- ▶ Communication with the decentralised modules is via a safe data link.
- ▶ The link module PNOZ m EF PDP Link reads the input information from the decentralised modules as part of each cycle and then forwards it to the base unit.
- ▶ At the end of a PNOZmulti cycle, the base unit sends its output data to its link module. This output data is immediately sent to the decentralised modules.

#### **Linking several decentralised modules:**

- ▶ A maximum of 4 link modules can be connected to a base unit PNOZmulti 2.
- ▶ A maximum of 4 decentralised modules can be connected to a link module PNOZ m EF PDP Link.
- ▶ If a decentralised module receives data intended for a different decentralised module that is connected, the data is forwarded without being processed.

### 4.3 System reaction time

Calculation of the maximum reaction time between an input switching off and a linked output in the system switching off is described in the document "PNOZmulti System Expansion".

### 4.4 Block diagram

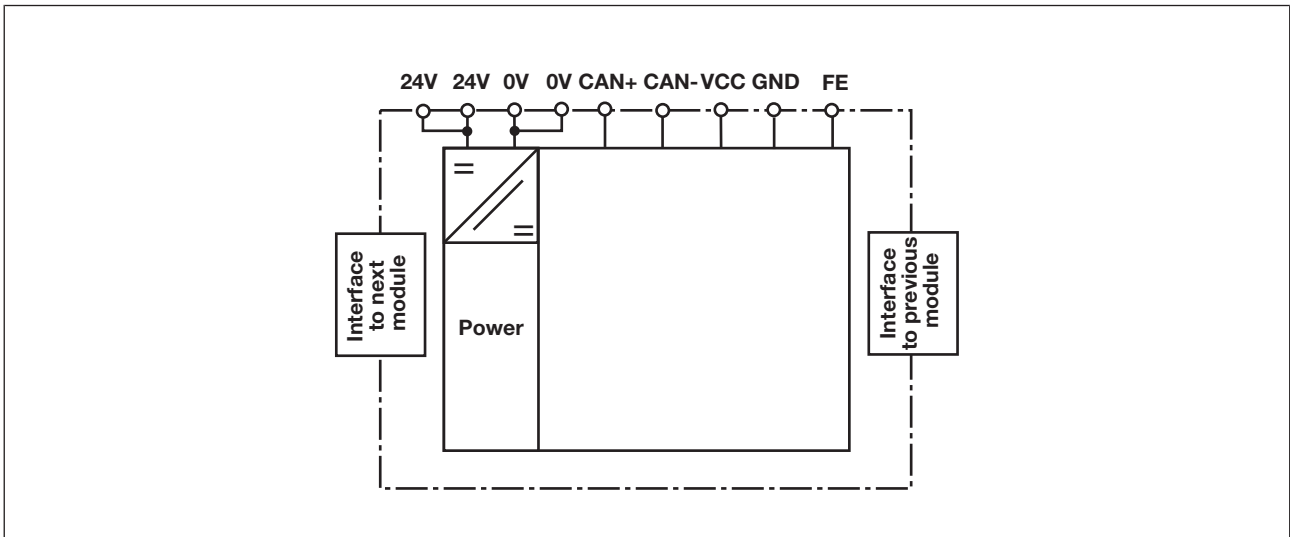

## 5 Installation

### 5.1 General installation guidelines

- ▶ The unit should be installed in a control cabinet with a protection type of at least IP54.
- ▶ Fit the safety system to a horizontal mounting rail. The venting slots must face upward and downward. Other mounting positions could damage the safety system.
- ▶ Use the locking elements on the rear of the unit to attach it to a mounting rail.
- ▶ In environments exposed to heavy vibration, the unit should be secured using a fixing element (e.g. retaining bracket or end angle).
- ▶ Open the locking slide before lifting the unit from the mounting rail.
- ▶ To comply with EMC requirements, the mounting rail must have a low impedance connection to the control cabinet housing.
- ▶ The ambient temperature of the PNOZmulti units in the control cabinet must not exceed the figure stated in the technical details. Air conditioning may otherwise be required.



#### NOTICE

Damage due to electrostatic discharge!

Electrostatic discharge can damage components. Ensure against discharge before touching the product, e.g. by touching an earthed, conductive surface or by wearing an earthed armband.

### 5.2 Dimensions in mm

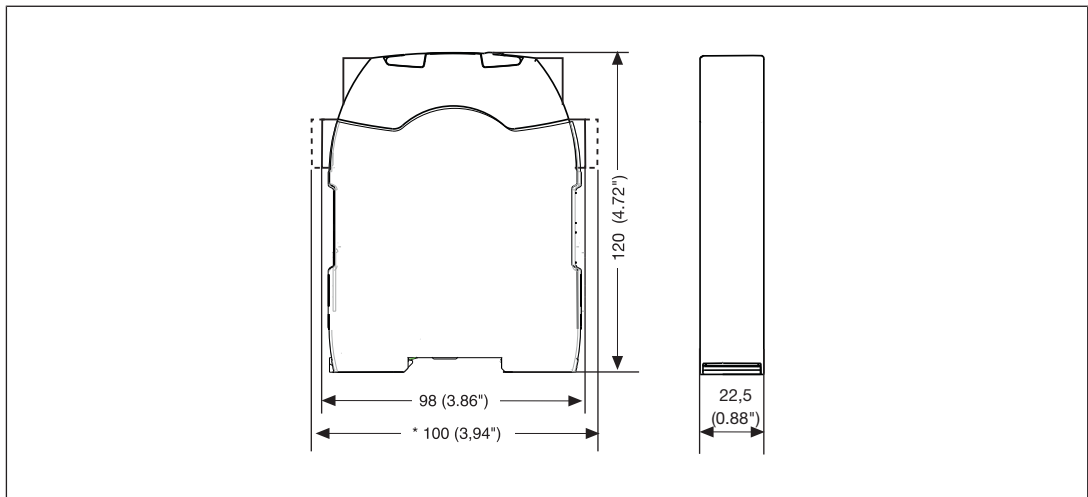

### 5.3 **Connect the base unit and expansion modules**

Connect the base unit and the expansion module as described in the operating instructions for the base units.

- ▶ Connect the black/yellow terminator to the expansion module.
- ▶ Install the expansion module in the position in which it is configured in the PNOZmulti Configurator.

The position of the expansion modules is defined in the PNOZmulti Configurator. The expansion modules are connected to the left or right of the base unit, depending on the type.

Please refer to the document "PNOZmulti System Expansion" for details of the number of modules that can be connected to the base unit and the module types.

## 6 Commissioning

### 6.1 Wiring

The wiring is defined in the circuit diagram of the PNOZmulti Configurator.

Please note:

- ▶ Information given in the [Technical details \[26\]](#) must be followed.
- ▶ The position of the expansion module is specified in the Hardware configuration of the PNOZmulti Configurator.
- ▶ Use copper wiring with a temperature stability of 75 °C.
- ▶ External measures must be used to connect the FE terminal to the functional earth (e.g. mounting rail).
- ▶ The power supply must meet the regulations for extra low voltages with protective electrical separation (SELV, PELV).
- ▶ Use a power supply with a buffer of 20 ms as a protection against temporary interruption of the supply voltage.
- ▶ 2 connection terminals are available for each of the supply connections 24 V and 0 V. This means that the supply voltage can be looped through several connections. The current at each terminal may not exceed 3 A.
- ▶ Please refer to the technical details for information on the maximum cable length. Please also read the section entitled "Voltage drop".
- ▶ With a cable length of 30 m or above, or in environments with strong interfaces, shielded cables must be used.
- ▶ If there are signal interferences/EMC problems that are to be expected or present, we recommend that you use a shielded cable from the beginning. In addition, you can place the braided shield of the cables directly next to the device via a shielded terminal to the functional earth (mounting rail).
- ▶ Pilz pre-assembled cable can be used to connect the decentralised modules (see order reference).
- ▶ The plug-in connection terminals are either designed as cage clamp terminals or screw terminals (see order reference).



#### CAUTION!

Only connect and disconnect the expansion module when the supply voltage is switched off.

### 6.1.1 Insulation voltage test

The product PNOZ m EF PDP Link is connected to functional earth  via protection elements on the supply voltage. Insulation voltage tests are only possible with voltages up to ca. 42 V.

## 6.2 Connection

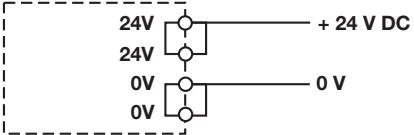
Supply voltage	AC	DC
	/	

**Connection to a decentralised input module PDP67 when using the PSEN op cable axial M12 5-pole from Pilz (see order reference)**

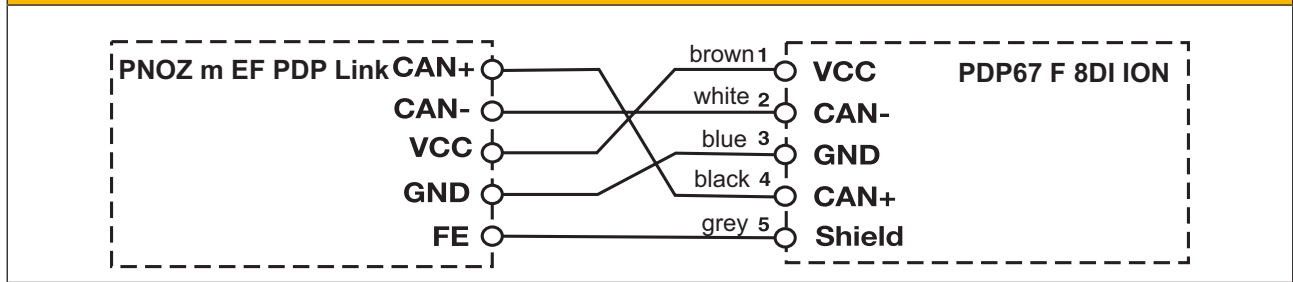

**Connection when using the PSS SB BUSCABLE LC in conjunction with a Pilz self-assembly "PSS67 M12 connector" (see order reference in the Technical Catalogue)**

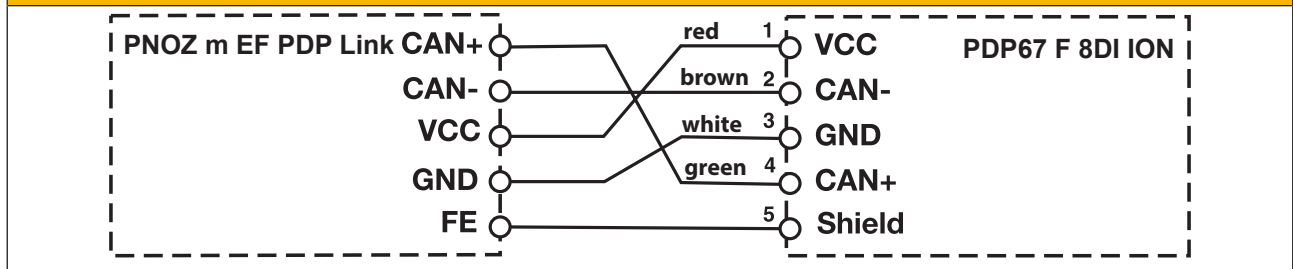

### 6.3 Download modified project to the PNOZmulti safety system

As soon as an additional expansion module has been connected to the system, the project must be amended in the PNOZmulti Configurator and downloaded back into the base unit. Proceed as described in the operating manual for the base unit.



**NOTICE**

For the commissioning and after every user program change, you must check whether the safety devices are functioning correctly.

## 6.4 Series connection of 4 decentralised modules

You can connect up to 4 decentralised modules in series to a PNOZmulti link module.

The cable length between every connection must be max. 100 m (see [Technical details \[26\]](#)).

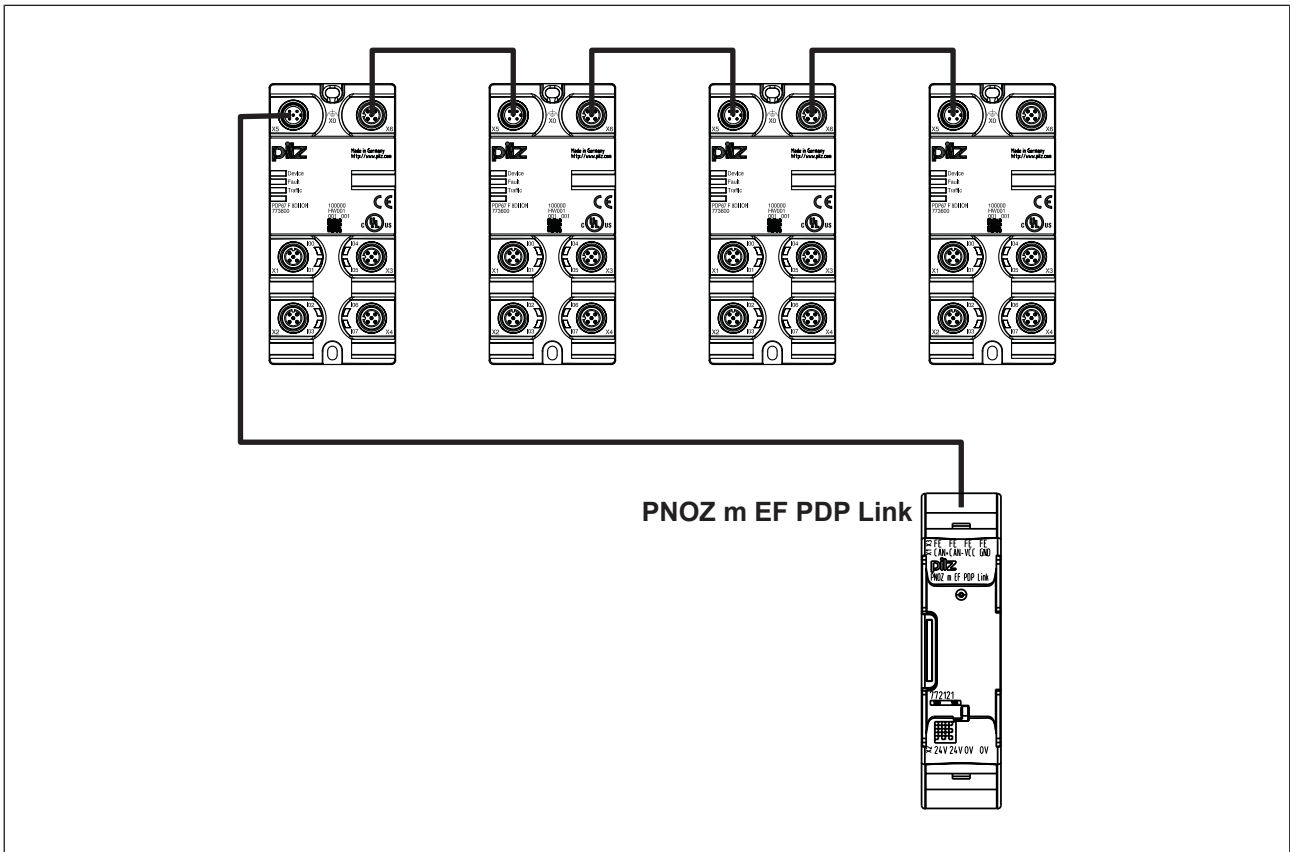

## 6.5 Voltage drop

The max. cable length depends on the voltage drop in the supply voltage cables. The level of voltage drop is determined by the:

- ▶ Cable resistance on the supply voltage cables
- ▶ Operating current of the modules
- ▶ Load on the modules

To increase the max. cable length, the input voltage can be permanently increased by the voltage tolerance (see Technical Details).

### 6.5.1 Guidelines for various cable types

Cable type	Voltage drop per 10 m and per 100 mA
PSS SB BUSCABLE LC	0.1 V
Sensor cable 0.25 mm <sup>2</sup>	0.15 V
Sensor cable 0.34 mm <sup>2</sup>	0.11 V
Sensor cable 0.5 mm <sup>2</sup>	0.07 V

### 6.5.2 Calculation example

- ▶ The PSS SB BUSCABLE LC is used in accordance with the pin assignment in section 6.2.2.

Voltage drop per 10 m and per 100 mA: 0.1 V

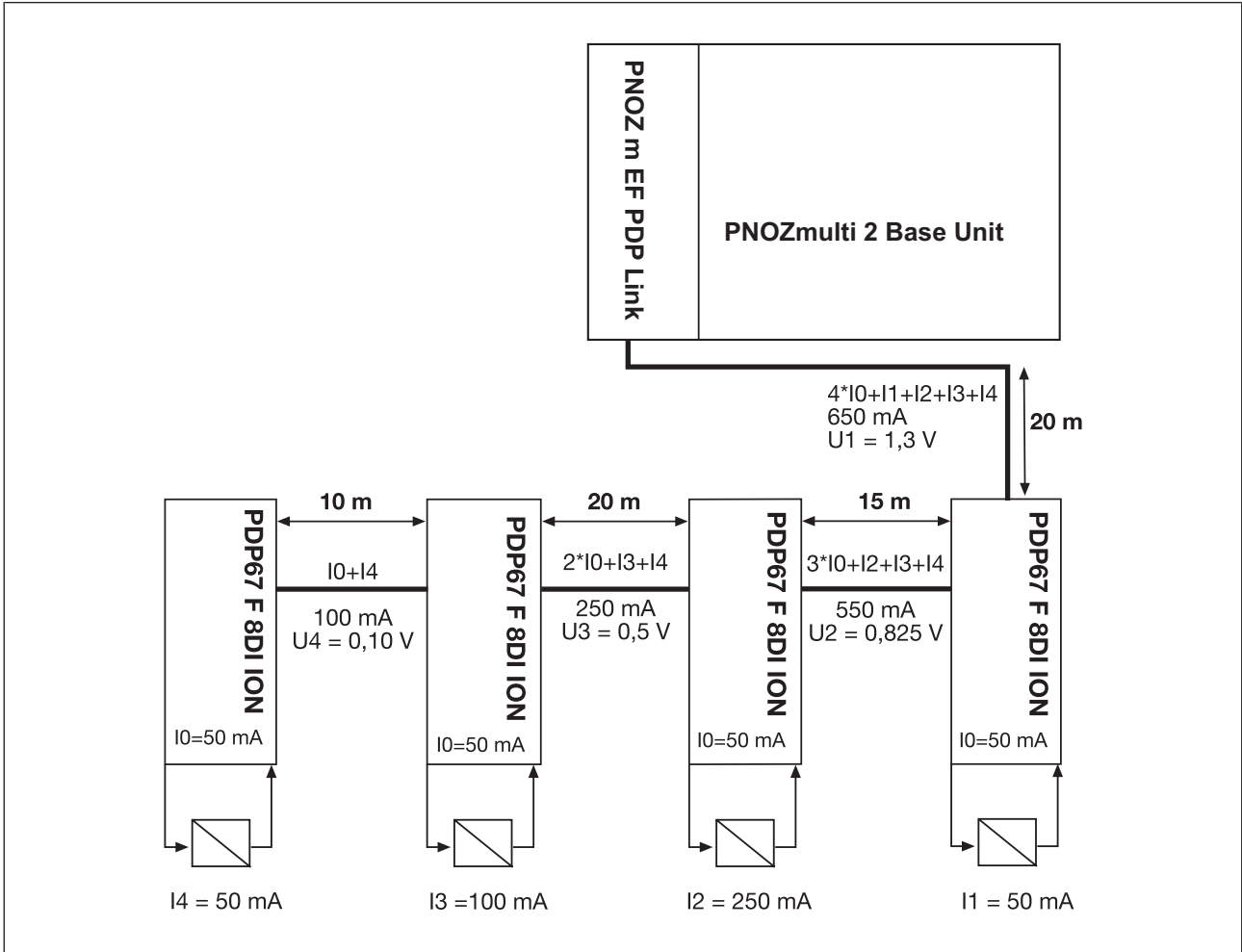

Legend:

- ▶  $I_0$ : Module's consumption.
- ▶  $I_1 \dots I_5$ : Load current taken from the module
- ▶  $U_1 \dots U_4$ : Voltage drop on the respective connection path

Total voltage drop from the link module PNOZ m EF PDP Link to the final PDP67 F 8DI ION:

$$U_{\text{total}} = U_1 + U_2 + U_3 + U_4$$

$$U_{\text{total}} = 1.3 \text{ V} + 0.825 \text{ V} + 0.5 \text{ V} + 0.10 \text{ V} = 2.725 \text{ V}$$

# 7 Operation

## Prerequisites

- ▶ The product is configured in the PNOZmulti 2 project.
- ▶ The product is installed and wired correctly.
- ▶ You have read the chapter on Safety and Security and complied with the requirements.



## Procedure







- ▶ Switch off the supply voltage on the base unit.

The PNOZmulti safety system is ready for operation when the "POWER" and "RUN" LEDs on the base unit and the "READY" LED on the PNOZ m EF PDP Link are lit continuously.

## 7.1 LED indicators

### Legend

-  LED on
-  LED flashes
-  LED off

LED	LED status		Meaning
Power	●		No supply voltage
		Green	Supply voltage is present
Ready		Green	The unit is ready for operation
	●		The unit is not ready for operation
Fault		Red	External error
		Red	Internal error
	●		No fault
Traffic		Yellow	Connection to a decentralised module available
		Yellow	Connection is not available to all decentralised modules.
	●		No connection to a decentralised module

## 7.2 Fault detection

The base unit contains information about the

- ▶ Link module (in order, defective, no supply voltage)
- ▶ Status of communication with the decentralised modules (data valid, data invalid)

If the connection to a decentralised module is interrupted or there is a major error on the decentralised module, the inputs on the devices connected to the link module are set to zero. The base unit remains in a RUN condition.

## 8 Maintenance and testing

It is not necessary to perform maintenance work on the product in normal operation.

- ▶ Please return any faulty product to Pilz.

## 9 Decommissioning



### INFORMATION

If you take the product PNOZ m EF PDP Link out of operation, no further security measures are required. There is no need to delete user data, remove passwords or restore factory settings.

### 9.1 Disposal

- ▶ In safety-related applications, please comply with the mission time  $T_M$  stated in the safety-related characteristic data.
- ▶ When decommissioning, please comply with local regulations regarding the disposal of electronic devices (e.g. Electrical and Electronic Equipment Act).

## 10 Technical details

Where standards are undated, the 2026-01 valid editions apply.

<b>General</b>	
Certifications	<b>CE, EAC, KOSHA, TÜV, UKCA, cULus Listed</b>
Application range	<b>Failsafe</b>
<b>Electrical data</b>	
Supply voltage	
for	<b>Module supply</b>
Voltage	<b>24 V</b>
Kind	<b>DC</b>
Voltage tolerance	<b>-15 %/+20 %</b>
Output of external power supply (DC)	<b>100 W</b>
Output of external power supply (DC) at no load	<b>2,5 W</b>
External unit fuse protection F1	<b>6 A, circuit breaker 24 V DC, characteristic B</b>
Supply voltage	
for	<b>Module supply</b>
internal	<b>Via base unit</b>
Voltage	<b>3,3 V</b>
Kind	<b>DC</b>
Max. current consumption	<b>60 mA</b>
Power consumption	<b>0,2 W</b>
Max. power dissipation of module	<b>4 W</b>
Status indicator	<b>LED</b>
<b>Inputs</b>	
Maximum input delay	<b>15 ms</b>
<b>Semiconductor outputs</b>	
Switch-off delay	<b>5 ms</b>
<b>Test pulse outputs</b>	
Maximum output current, decentralised module supply	<b>4 A</b>
Short circuit protection of decentralised module supply	<b>Yes</b>
<b>Environmental data</b>	
Ambient temperature	
in accordance with the standard	<b>EN 60068-2-14</b>
Temperature range	<b>0 - 60 °C</b>
Storage temperature	
in accordance with the standard	<b>EN 60068-2-1/-2</b>
Temperature range	<b>-25 - 70 °C</b>
Climatic suitability	
in accordance with the standard	<b>EN 60068-2-30, EN 60068-2-78</b>
Condensation during operation	<b>Not permitted</b>
Max. operating height above SL	<b>2000 m</b>

<b>Environmental data</b>	
EMC	<b>EN 61131-2</b>
Vibration	
in accordance with the standard	<b>EN 60068-2-6</b>
Frequency	<b>5 - 55 Hz</b>
Acceleration	<b>1g</b>
Shock stress	
in accordance with the standard	<b>EN 60068-2-27</b>
Acceleration	<b>15g</b>
Duration	<b>11 ms</b>
Airgap creepage	
in accordance with the standard	<b>EN 61131-2</b>
Overvoltage category	<b>II</b>
Pollution degree	<b>2</b>
Protection type	
in accordance with the standard	<b>EN 60529</b>
Housing	<b>IP20</b>
Terminals	<b>IP20</b>
Mounting area (e.g. control cabinet)	<b>IP54</b>
<b>Potential isolation</b>	
Potential isolation between	<b>Module and system voltage</b>
Type of potential isolation	<b>Functional insulation</b>
Rated insulation voltage	<b>30 V</b>
Rated surge voltage	<b>2500 V</b>
<b>Mechanical data</b>	
Mounting position	<b>horizontally on mounting rail</b>
DIN rail	
Top hat rail	<b>35 x 15 EN/IEC 60715, 35 x 7,5 EN/IEC 60715</b>
Recess width	<b>27 mm</b>
Max. cable length unshielded	<b>30 m</b>
Max. cable length shielded	<b>100 m</b>
Material	
Bottom	<b>PC</b>
Front	<b>PC</b>
Top	<b>PC</b>
Connection type	<b>Spring-loaded terminal, screw terminal</b>
Mounting type	<b>plug-in</b>
Conductor cross section with screw terminals	
1 core flexible	<b>0,25 - 2,5 mm<sup>2</sup>, 24 - 12 AWG</b>
2 core with the same cross section, flexible without crimp connectors or with TWIN crimp connectors	<b>0,2 - 1,5 mm<sup>2</sup>, 24 - 16 AWG</b>
Torque setting with screw terminals	<b>0,5 Nm</b>
Conductor cross section with spring-loaded terminals:	
Flexible with/without crimp connector	<b>0,2 - 2,5 mm<sup>2</sup>, 24 - 12 AWG</b>
Spring-loaded terminals: Terminal points per connection	<b>2</b>

**Mechanical data**

Stripping length with spring-loaded terminals **9 mm**

Dimensions

Height **101,4 mm**

Width **22,5 mm**

Depth **120 mm**

Weight **96 g**

Where standards are undated, the 2026-01 latest editions shall apply.

**Year of manufacture**

The year of manufacture is specified on the product after the reference YOM (Year of Manufacturing).

**10.1 Safety characteristic data**



**NOTICE**

You must comply with the safety characteristic data in order to achieve the required safety level for your plant/machine.

Operating mode	EN ISO 13849-1: 2023	EN ISO 13849-1: 2023	EN IEC 62061 SIL CL/max.	EN IEC 62061 61508	EN/IEC 61511 61508	EN/IEC 61511 61508	EN ISO 13849-1: 2023
	PL	Category	SIL	PFH [1/h]	SIL	PFD	T <sub>M</sub> [year]
–	PL e	Cat. 4	SIL 3	5,35E-09	SIL 3	3,30E-05	20

Explanatory notes for the safety-related characteristic data:

- ▶ T<sub>M</sub> is the maximum mission time in accordance with EN ISO 13849-1. The value also applies as the retest interval in accordance with EN IEC 61508-6 and EN IEC 61511 and as the proof test interval and mission time in accordance with EN IEC 62061.

All the units used within a safety function must be considered when calculating the safety characteristic data.



**INFORMATION**

A safety function's SIL/PL values are **not** identical to the SIL/PL values of the products used and may differ from these.

# 11 Order reference

## 11.1 Product

Product type	Features	Order no.
PNOZ m EF PDP Link	Configurable safe small controllers PNOZmulti 2, expansion module, safe connection decentralised I/O modules.	772121

## 11.2 Accessories

### 11.2.1 Terminals

Product type	Features	Product ID
Spring terminals PNOZ mml2p	Spring-loaded terminals, PNOZ mml2p, 1 set.	783540
Screw terminals PNOZ mml2p	Plug-in screw terminals, PNOZ mml2p, 1 set.	793540
Spring terminals PNOZ mml2p 10 pcs.	Spring-loaded terminals, PNOZ mml2p, 10 sets.	783541
Screw terminals PNOZ mml2p 10 pcs.	Plug-in screw terminals, PNOZ mml2p, 10 sets.	793541

### 11.2.2 Connector plug

Product type	Features	Order no.
PNOZ mm0.xp connector left (10 pcs)	Connector plug to connect the modules to the left-hand side of the PNOZmulti base unit, yellow/black (10 pieces).	779260

### 11.2.3 By the metre

Product type	Features	Order no.
PSS SB BUSCABLE LC	By the metre, bus/power hybrid line, PUR, yellow RAL1003, 2x0.38+2x0.24+1x0.38, colour of the single wires: Red, white, green, brown	311074
PSS67 I/O Cable	By the metre, PUR, yellow RAL1003, 5x0.25, colour of the single wires: Brown, white, blue, black, grey	380320

### 11.2.4 Cable

Product type	Features	Order no.
PSS67 Cable M8sf M12sm, 3m	Connection cable, PUR, yellow RAL1003, suitable for drag chains, 4-pin, socket straight M8, on connector straight M12, A-coded, cable length: 3 m.	380200
PSS67 Cable M8sf M12sm, 5m	Connection cable, PUR, yellow RAL1003, suitable for drag chains, 4-pin, socket straight M8, on connector straight M12, A-coded, cable length: 5 m	380201
PSS67 Cable M8sf M12sm, 10m	Connection cable, PUR, yellow RAL1003, suitable for drag chains, 4-pin, socket straight M8, on connector straight M12, A-coded, cable length: 10 m	380202
PSS67 Cable M8sf M12sm, 30m	Connection cable, PUR, yellow RAL1003, suitable for drag chains, 4-pin, socket straight M8, on connector straight M12, A-coded, cable length: 30 m	380203
PSS67 Cable M8af M12sm, 3m	Connection cable, PUR, yellow RAL1003, suitable for drag chains, 4-pin, socket angled M8, on connector straight M12, A-coded, cable length: 3 m	380204
PSS67 Cable M8af M12sm, 5m	Connection cable, PUR, yellow RAL1003, suitable for drag chains, 4-pin, socket angled M8, on connector straight M12, A-coded, cable length: 5 m	380205
PSS67 Cable M8af M12sm, 10m	Connection cable, PUR, yellow RAL1003, suitable for drag chains, 4-pin, socket angled M8, on connector straight M12, A-coded, cable length: 10 m	380206
PSS67 Cable M8af M12sm, 30m	Connection cable, PUR, yellow RAL1003, suitable for drag chains, 4-pin, socket angled M8, on connector straight M12, A-coded, cable length: 30 m	380207
PSS67 Cable M12sf M12sm, 3m	Connection cable, PUR, yellow RAL1003, 5-pin, socket straight, on connector straight M12, A-coded, cable length: 3 m	380208
PSS67 Cable M12sf M12sm, 5m	Connection cable, PUR, yellow RAL1003, 5-pin, socket straight, on connector straight M12, A-coded, cable length: 5 m	380209
PSS67 Cable M12sf M12sm, 10m	Connection cable, PUR, yellow RAL1003, 5-pin, socket straight, on connector straight M12, A-coded, cable length: 10 m	380210
PSS67 cable M12-5sf, M12-5sm, 20m	Connection cable, PUR, yellow RAL1003, 5-pin, socket straight, on connector straight M12, A-coded, cable length: 20 m	380220
PSS67 Cable M12sf M12sm, 30m	Connection cable, PUR, yellow RAL1003, 5-pin, socket straight, on connector straight M12, A-coded, cable length: 30 m	380211
PSS67 Cable M12af M12am, 3m	Connection cable, PUR, yellow RAL1003, 5-pin, socket angled, on connector angled M12, A-coded, cable length: 3 m	380212
PSS67 Cable M12af M12am, 5m	Connection cable, PUR, yellow RAL1003, 5-pin, socket angled, on connector angled M12, A-coded, cable length: 5 m	380213
PSS67 Cable M12af M12am, 10m	Connection cable, PUR, yellow RAL1003, 5-pin, socket angled, on connector angled M12, A-coded, cable length: 10 m	380214
PSS67 Cable M12af M12am, 30m	Connection cable, PUR, yellow RAL1003, 5-pin, socket angled, on connector angled M12, A-coded, cable length: 30 m	380215
PSEN op cable axial M12 5-pole 3m	Connection cable, PUR, yellow, RAL1003, 5-pin, socket straight M12, on open line end, A-coded, cable length: 3 m	630310

Product type	Features	Order no.
PSEN op cable axial M12 5-pole 5m	Connection cable, PUR, yellow, RAL1003, 5-pin, socket straight M12, on open line end, A-coded, cable length: 5 m	630311
PSEN op cable axial M12 5-pole 10m	Connection cable, PUR, yellow, RAL1003, 5-pin, socket straight M12, on open line end, A-coded, cable length: 10 m	630312
PSEN cable M12-5sf 20m	Connection cable, PUR, yellow, RAL1003, 5-pin, socket straight M12, on open line end, A-coded, cable length: 20 m	630298
PSEN op cable axial M12 5-pole 30m	Connection cable, PUR, yellow, RAL1003, 5-pin, socket straight M12, on open line end, A-coded, cable length: 30 m	630297

### 11.2.5 Adapter

Product type	Features	Order no.
PSEN ma adapter	Cable, adapter, IP68, M12 female connector, black, straight, 4-pin, A-coded on M12 male connector, black, angled, 5-pin, A-coded, PUR, 0.1 m, 4x 0.34 mm <sup>2</sup> , black, for connecting the sensors PSEN-mag (safety switch)/PIT en1.0 (enabling switch) to PSS67 and PDP67.	380300
PSEN cs adapter	Cable, adapter, IP68, M12 female connector, black, straight, 8-pin, A-coded on M12 male connector, black, angled, 5-pin, A-coded, PUR, 0.1 m, 5x 0.25 mm <sup>2</sup> , black, with shielding (wire mesh), for connecting a PSENcode sensor (coded safety switch) to PSS67 and PDP67.	380301
PSEN sl adapter	Cable, adapter, IP68, M12 female connector, black, straight, 8-pin, A-coded on M12 male connector, black, angled, 5-pin, A-coded, PUR, 0.1 m, 5x 0.25 mm <sup>2</sup> , black, with shielding (wire mesh), for connecting a PSENSlock sensor (safety gate monitoring) to PSS67 and PDP67.	380325

### 11.2.6 Plug-in connector

Product type	Features	Order no.
PSS67 M12 connector, straight, male, 5 pole	Plug-in connector, 5-pin, straight M12 connector, A-coded, screw connection, material ring nut: CuZn nickel-plated, outer cable diameter: 4 - 6 mm	380308
PSS67 M12 connector straight, female, 5pin	Plug-in connector, 5-pin, straight M12 socket, A-coded, screw connection, material ring nut: CuZn nickel-plated, outer cable diameter: 4 - 6 mm	380309
PSS67 M12 connector, angled, male, 5pole	Plug-in connector, 5-pin, angled M12 connector, A-coded, screw connection, material ring nut: CuZn nickel-plated, outer cable diameter: 4 - 6 mm	380310
PSS67 M12 connector, angled, female, 5pole	Plug-in connector, 5-pin, angled M12 socket, A-coded, screw connection, material ring nut: CuZn nickel-plated, outer cable diameter: 4 - 6 mm	380311
M12 con., straight, male, 4-pin, D	Plug-in connector, 4-pin, straight M12 connector, D-coded, IDC connection, material ring nut: Die-cast zinc nickel-plated, cable screw connection Pg9, outer cable diameter 6 - 8 mm	380316

Product type	Features	Order no.
M12 con., straight, female, 5 pin, L, S	Plug-in connector, 5-pin (4+FE), shielded, straight M12 socket, L-coded (power), crimp connection, material ring nut: Die-cast zinc nickel-plated, cable screw connection Pg11, outer cable diameter 5 - 9 mm	380317
M12 con., straight, male, 5 pin, L, S	Plug-in connector, 5-pin (4+FE), shielded, straight M12 socket, L-coded (power), crimp connection, material ring nut: Die-cast zinc nickel-plated, cable screw connection Pg11, outer cable diameter 5 - 9 mm	380318

## 12 EU/EC declaration of conformity

These products meet the requirements of the directive 2006/42/EC on machinery up to and including 19 January 2027, and the EU regulation 2023/1230 of the European Parliament and of the Council from 20 January 2027. The full EU and EC declaration of conformity is available to download at [www.pilz.com/manuals](http://www.pilz.com/manuals).

Authorised representative: Pilz GmbH & Co. KG, Felix-Wankel-Str. 2, 73760 Ostfildern, Germany

## 13 UKCA-Declaration of Conformity

These products comply with following UK legislation: Supply of Machinery (Safety) Regulation 2008.

The complete UKCA Declaration of Conformity is available on the Internet at [www.pilz.com/manuals](http://www.pilz.com/manuals).

Representative: Pilz Automation Technology, Pilz House, Little Colliers Field, Corby, Northamptonshire, NN18 8TJ United Kingdom, eMail: [mail@pilz.co.uk](mailto:mail@pilz.co.uk)

# Support

Technical support is available from Pilz round the clock.

## Americas

### Brazil

+55 11 97569-2804

### Canada

+1 888 315 7459

### Mexico

+52 55 5572 1300

### USA (toll-free)

+1 877-PILZUSA (745-9872)

## Asia

### China

+86 400-088-3566

### Japan

+81 45 471-2281

### South Korea

+82 31 778 3390

## Australia and Oceania

### Australia

+61 3 95600621

### New Zealand

+64 9 6345350

## Europe

### Austria

+43 1 7986263-444

### Belgium, Luxembourg

+32 9 3217570

### France

+33 3 88104003

### Germany

+49 711 3409-444

### Ireland

+353 21 4804983

### Italy, Malta

+39 0362 1826711

## Scandinavia

+45 74436332

## Spain

+34 938497433

## Switzerland

+41 62 88979-32

## The Netherlands

+31 347 320477

## Türkiye

+90 216 5775552

## United Kingdom

+44 1536 460866

## You can reach our international hotline on:

+49 711 3409-222

support@pilz.com

## Reporting security vulnerabilities or security incidents

If you would like to report a security vulnerability or a security incident in connection with a Pilz product, please contact our **Pilz Product Security Incident Response Team (PSIRT)**.

You can reach us at: [www.pilz.com/psirt](http://www.pilz.com/psirt)

Pilz develops environmentally-friendly products using ecological materials and energy-saving technologies. Offices and production facilities are ecologically designed, environmentally-aware and energy-saving. So Pilz offers sustainability, plus the security of using energy-efficient products and environmentally-friendly solutions.



[www.pilz.com/facebook](http://www.pilz.com/facebook)



[www.pilz.com/linkedin](http://www.pilz.com/linkedin)



[www.pilz.com/xing](http://www.pilz.com/xing)



[www.pilz.com/youtube](http://www.pilz.com/youtube)



1003019-EN-09, 2026-03 Printed in Germany  
© Pilz GmbH & Co. KG, 2024

CECE, CHRE, CMSE®, IndustrialPi®, Leansate®, MYZEL®, PAS4000®, PAScal®, PASconfig®, Pilz®, PIIT®, PMCprimo®, PMCprotego®, PMCTendo®, PMD®, PMI®, PNOZ®, Primo®, PSEN®, PSS®, PVS®, SafetyBUS p®, SafetyNET p®, THE SPIRIT OF SAFETY® are registered and protected trademarks of Pilz GmbH & Co. KG in some countries. We would point out that product features may vary from the details stated in this document, depending on the status at the time of publication and the scope of the equipment. We accept no responsibility for the validity, accuracy and entirety of the text and graphics presented in this information. Please contact our Technical Support if you have any questions.

We are represented internationally. Please refer to our homepage [www.pilz.com](http://www.pilz.com) for further details or contact our headquarters.

Headquarters: Pilz GmbH & Co. KG, Felix-Wankel-Straße 2, 73760 Ostfildern, Germany  
Telephone: +49 711 3409-0, E-Mail: [info@pilz.com](mailto:info@pilz.com), Internet: [www.pilz.com](http://www.pilz.com)

**PILZ**  
THE SPIRIT OF SAFETY