



PMD s10

PILZ
THE SPIRIT OF SAFETY

► Monitoring relays

This document is the original document.

All rights to this documentation are reserved by Pilz GmbH & Co. KG. Copies may be made for the user's internal purposes. Suggestions and comments for improving this documentation will be gratefully received.

Source code from third-party manufacturers or open source software has been used for some components. The relevant licence information is available on the Internet on the Pilz homepage.

Pilz®, PIT®, PMI®, PNOZ®, Primo®, PSEN®, PSS®, PVIS®, SafetyBUS p®, SafetyEYE®, SafetyNET p®, the spirit of safety® are registered and protected trademarks of Pilz GmbH & Co. KG in some countries.



SD means Secure Digital

1	Introduction	5
1.1	Validity of documentation	5
1.2	Using the documentation	5
1.3	Definition of symbols	5
2	Safety	7
2.1	Intended use	7
2.2	Safety regulations	7
2.2.1	Use of qualified personnel	7
2.2.2	Warranty and liability	7
2.2.3	Disposal	8
2.3	For your safety	8
3	Unit features	9
4	Block diagram	10
5	Function description	11
6	Installation	14
7	Commissioning	15
7.1	Wiring	15
7.2	Connection	15
7.3	Application	15
7.3.1	Circuit for three-phase motor	16
7.3.2	Circuit for three-phase motor with CT and VT	17
7.3.3	Circuit for motor (1 AC)	18
7.3.4	Circuit for motor (1 AC) with CT	19
7.4	Read and set parameters	19
7.5	Display menu - Configuration	19
7.5.1	Rotary knob	19
7.5.2	Display	20
7.5.3	Use chip card	20
7.5.3.1	Insert chip card	21
7.5.3.2	Write data to chip card	22
7.5.3.3	Read data from chip card	22
7.5.3.4	Transfer device parameters	22
7.5.4	Menu overview	23
7.5.4.1	"Settings" menu and sub-menu	23
7.5.4.2	"Advanced Settings" menu and sub-menu	23
7.5.4.3	"Info" menu	24
7.5.4.4	"Settings", "Advanced Settings" and "Info" menu (schematic representation)	25
7.5.5	Set the parameter value	26
7.6	Procedure for setting parameters	27
7.6.1	Example configuration	28

8	Operation	30
8.1	Status messages	30
8.1.1	Error messages	30
9	Technical details	31
10	Order reference	35
11	EC declaration of conformity	36

1 Introduction

1.1 Validity of documentation

This documentation is valid for the true power converter PMD s10 from Version 2.0. It is valid until new documentation is published.

This operating manual explains the function and operation, describes the installation and provides guidelines on how to connect the product.

1.2 Using the documentation

This document is intended for instruction. Only install and commission the product if you have read and understood this document. The document should be retained for future reference.

1.3 Definition of symbols

Information that is particularly important is identified as follows:



DANGER!

This warning must be heeded! It warns of a hazardous situation that poses an immediate threat of serious injury and death and indicates preventive measures that can be taken.



WARNING!

This warning must be heeded! It warns of a hazardous situation that could lead to serious injury and death and indicates preventive measures that can be taken.



CAUTION!

This refers to a hazard that can lead to a less serious or minor injury plus material damage, and also provides information on preventive measures that can be taken.



NOTICE

This describes a situation in which the product or devices could be damaged and also provides information on preventive measures that can be taken. It also highlights areas within the text that are of particular importance.



INFORMATION

This gives advice on applications and provides information on special features.

2 Safety

2.1 Intended use

The true power converter PMD s10 used to measure and monitor the rated power or true power on electrical consumers.

It is designed for use on:

- ▶ True power converter for single and three-phase electrical machinery
- ▶ Trip device for underload and overload

The following is deemed improper use in particular

- ▶ Any component, technical or electrical modification to the product,
- ▶ Use of the product outside the areas described in this manual,
- ▶ Use of the product outside the technical details (see [Technical details](#)  31]).



NOTICE

EMC-compliant electrical installation

The product is designed for use in an industrial environment. The product may cause interference if installed in other environments. If installed in other environments, measures should be taken to comply with the applicable standards and directives for the respective installation site with regard to interference.

2.2 Safety regulations

2.2.1 Use of qualified personnel

The products may only be assembled, installed, programmed, commissioned, operated, maintained and decommissioned by competent persons.

A competent person is a qualified and knowledgeable person who, because of their training, experience and current professional activity, has the specialist knowledge required. To be able to inspect, assess and operate devices, systems and machines, the person has to be informed of the state of the art and the applicable national, European and international laws, directives and standards.

It is the company's responsibility only to employ personnel who

- ▶ Are familiar with the basic regulations concerning health and safety / accident prevention,
- ▶ Have read and understood the information provided in the section entitled Safety
- ▶ Have a good knowledge of the generic and specialist standards applicable to the specific application.

2.2.2 Warranty and liability

All claims to warranty and liability will be rendered invalid if

- ▶ The product was used contrary to the purpose for which it is intended,
- ▶ Damage can be attributed to not having followed the guidelines in the manual,

- ▶ Operating personnel are not suitably qualified,
- ▶ Any type of modification has been made (e.g. exchanging components on the PCB boards, soldering work etc.).

2.2.3 Disposal

- ▶ When decommissioning, please comply with local regulations regarding the disposal of electronic devices (e.g. Electrical and Electronic Equipment Act).

2.3 For your safety

The unit meets all the necessary conditions for safe operation. However, please note the following:

- ▶ Transport, storage and operating conditions should all conform to EN 60068-2-6 (see "Technical details"). The unit must be disposed of properly when it reaches the end of its service life.
- ▶ Sufficient protection must be provided on all output contacts with capacitive and inductive loads.
- ▶ Note for overvoltage category III:
If voltages higher than low voltage (>50 V AC or >120 V DC) are present on the unit, connected control elements and sensors must have a rated insulation voltage of at least 250 V

3 Unit features

- ▶ Relay outputs:
 - 2 auxiliary changeover contacts (C/O)
- ▶ Analogue output for current and voltage
- ▶ Galvanic isolation of analogue outputs
- ▶ Automatic measuring range is set automatically for current and voltage
- ▶ The following unit parameter settings are menu-driven and infinitely variable via a display and rotary knob with key function (turn and push):
 - Maximum true power
 - Switching threshold for underload and overload
 - Warning threshold
 - Monitoring reaction time
 - Start-up suppression time
 - Allocation of switching threshold to relay
 - Hysteresis of the switching thresholds
 - Automatic/manual reset
 - Range selection for Uout and Iout
 - Offset for Uout and Iout
 - Relay function norm. on/off
 - CT 1 : 1 ... 1000 : 1
 - VT 1 : 1 ... 100 : 1
- ▶ LED display for:
 - Supply voltage
 - Switching threshold for overload
 - Switching threshold for underload
 - Output 1
 - Output 2
 - Error
- ▶ Display for measured value indicator, diagnostics and menu navigation
- ▶ Operating cycle counter for K1 and K2
- ▶ Diagnostics: Umax and Imax
- ▶ Display of operating hours and load hours (resettable)
- ▶ Device parameters can be saved to chip card (write)
- ▶ Device parameters can be restored from the chip card (load)
- ▶ Suitable for use with frequency-controlled drives
- ▶ Suitable for current transformers
- ▶ Suitable for voltage transformers

4 Block diagram

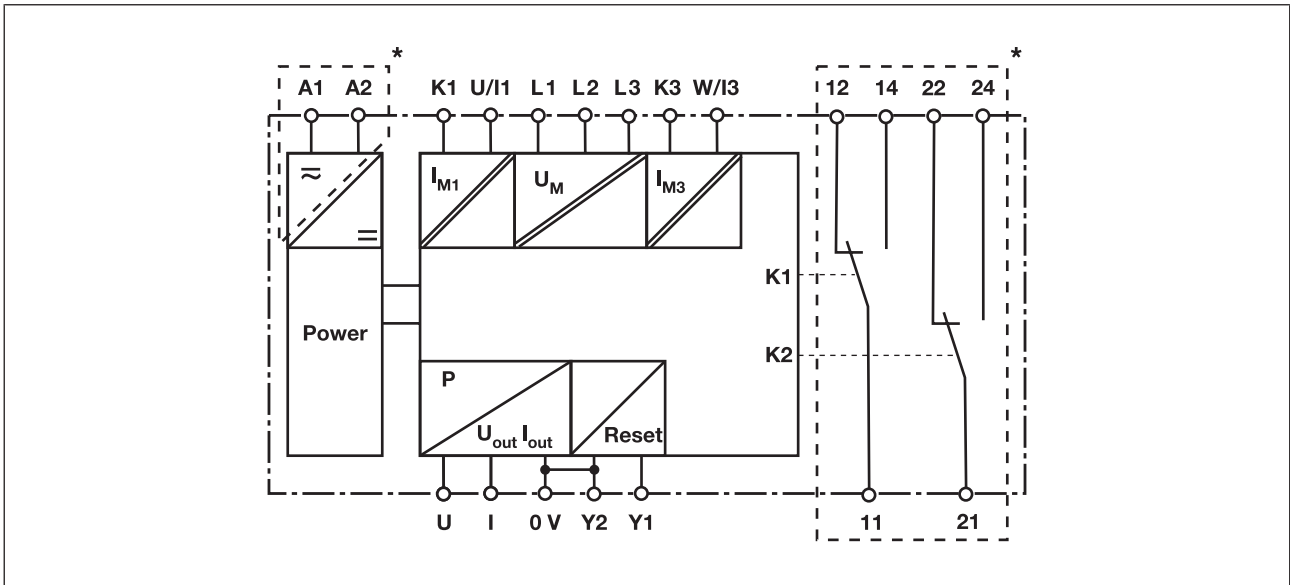

*Insulation between the non-marked area and the relay contacts: Basic insulation (over-voltage category III), Protective separation (over-voltage category II)

5 Function description

The PMD s10 monitors the set upper and lower true power limit on a single or three phase supply or on the DC supply. The unit operates in accordance with the principle of Aron circuit.

▶ Relay outputs (K1 and K2):

K1 and K2 operate in normally energised mode. In their default state, auxiliary contacts 11-14 and 21-24 are closed and auxiliary contacts 11-12 and 21-22 are open. Normally energised mode is the default setting. This setting can be changed via the menu.

▶ Analogue outputs (Uout and Iout):

The unit forms two output signals which are proportional to the true power. The final value /limit value/ end value corresponds to Pmax (see function diagram). The status of the threshold monitoring function is displayed at the auxiliary contacts and LEDs, along with the analogue output signals. The hysteresis of the switching thresholds can be set between 0 % ... 50 %.

▶ Current transformer CT:

With continuous currents > 12 A the measuring current must be measured via an external current transformer.

▶ Voltage transformer VT:

With constant voltage > 500 V the voltage has to be measured via an external voltage transformer.

▶ Po function (K1 overload):

If the measured true power exceeds the switching threshold Po, the LED "> max" is lit. Once the reaction time has elapsed (tr), the auxiliary contact switches (default: relay K1) and the "Out 1" LED is lit.

▶ Pwo function (overload warning threshold):

Serves as a warning. See Po function (K1 overload).

▶ Po function (K2 underload):

If the measured true power exceeds the switching threshold Po, the LED "> min" is lit. Once the reaction time has elapsed (tr), the auxiliary contact switches (default: relay K2) and the "Out 2" LED is lit.

▶ Pwu function (underload warning threshold):

Serves as a warning. See Pu function (K2 underload).

▶ Start-up suppression time (tstart):

The measurement is suppressed during the machine's start-up phase, in order to avoid spurious output signals. The start-up suppression time tstart is infinitely variable.

▶ Reaction time (tr):

In the case of transient load fluctuations, the switching threshold can be suppressed. The reaction time tr is infinitely variable.

▶ Reset mode (Reset):

The fault status (value below Pu or above Po) can be reset automatically or via an external reset button.



INFORMATION

If the measured values contain harmonics or are not sinusoidal, discrepancies may occur between the calculated true power and the actual true power.

Function diagram 1

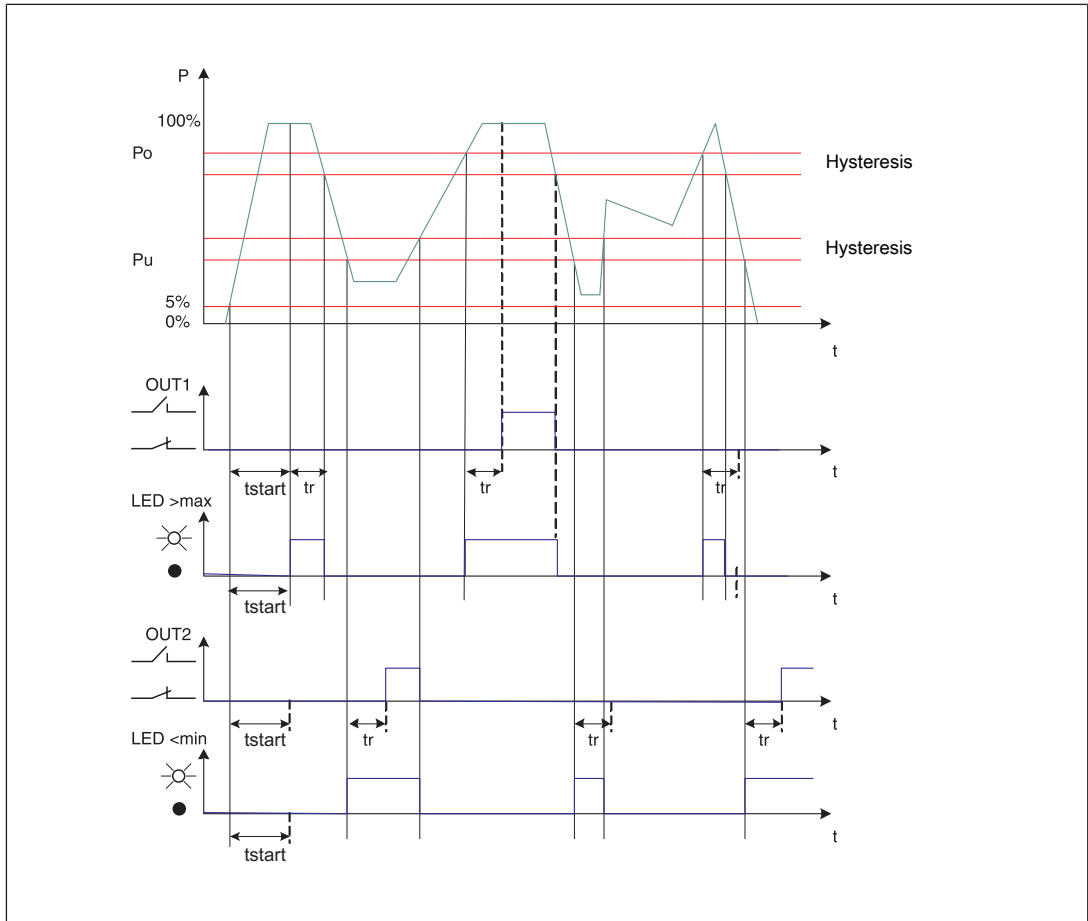

Legend

- ▶ P: Actual true power
- ▶ t_{start} : Start-up suppression time
- ▶ t_r : Reaction time

Function diagram 2

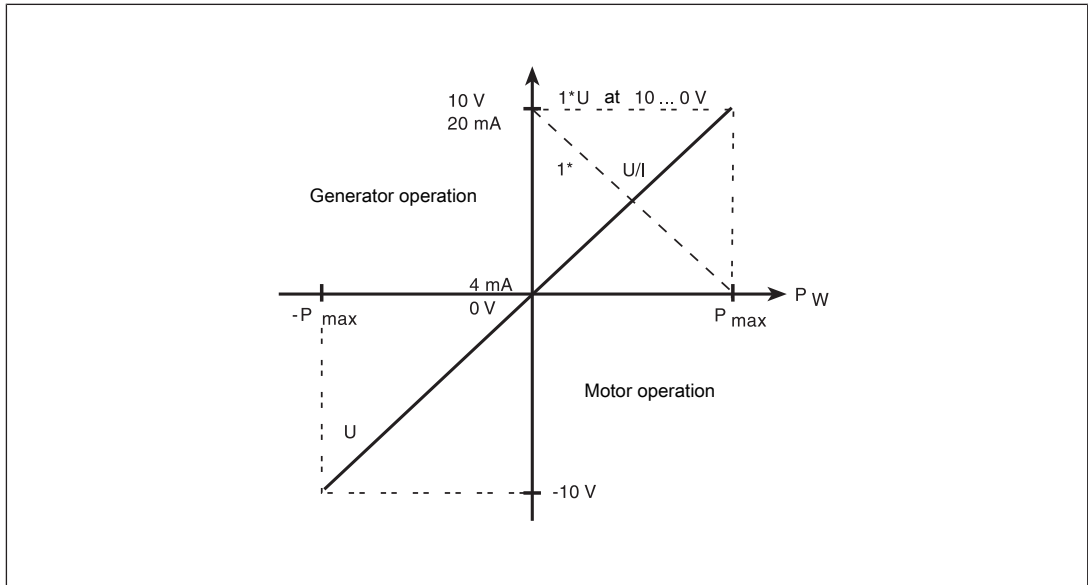

Legend

- ▶ P: Actual true power
- ▶ U/I: Analogue output signal



INFORMATION

Measuring range limit value Pmax (selectable)

When simultaneously using an external current and an external voltage transformer, the selectable measuring range limit value is calculated from the following formula:

$$P_{max} = (1.0 \text{ W} \dots 11.5 \text{ kW}) \times CT \times VT$$

Examples:

1. Current transformer CT 100 : 1 and no voltage transformer VT 1 : 1
 $P_{max} = (1.0 \text{ W} \dots 11.5 \text{ kW}) \times 100 \times 1 = 100 \text{ W} \dots 1.5 \text{ MW}$
2. Current transformer CT 1000 : 1 and voltage transformer VT 100 : 1
 $P_{max} = (1.0 \text{ W} \dots 11.5 \text{ kW}) \times 1000 \times 100 = 100 \text{ kW} \dots 1.5 \text{ GW}$

6 Installation

- ▶ The unit should be installed in a control cabinet with a protection type of at least IP54.
- ▶ Use the notch on the rear of the unit to attach it to a mounting rail.
- ▶ In environments exposed to heavy vibration or when installing on a vertical mounting rail (35 mm), the unit should be secured using a fixing element (e.g. retaining bracket or end angle).
- ▶ Push the unit upwards or downwards before lifting it from the mounting rail.

7 Commissioning

7.1 Wiring

Please note:

- ▶ Only wire the unit when the supply voltage is switched off!
- ▶ Use copper wiring.
- ▶ To prevent contact welding, a fuse should be connected before the output contacts (see [Technical details \[31\]](#)).
- ▶ Ensure that the cables are laid carefully, because an open circuit in the measuring circuit will cause the unit to malfunction.
- ▶ Information given in the [Technical details \[31\]](#) must be followed.



NOTICE

Ensure that there is adequate fuse protection on the connection cables to terminals L1, L2, L3, K1, K3, A1 and A2!

7.2 Connection

- ▶ Connect the supply voltage UB to A1/A2.
- ▶ Single-phase:
 - Measuring voltage UM: Connect to terminals L1 and L2
 - Link terminals L1-K1
 - Measuring circuit: Connect phase L1 of the motors to terminal U/I1
- ▶ Three-phase:
 - Measuring voltage UM: Connect to terminals L1, L2 and L3
 - Link terminals L1-K1, L3-K3
 - Measuring circuit: Connect phase L1 of the motor to terminal U/I1, phase L2 to terminal L2 and L3 to W/I3
- ▶ Please refer to the connection diagrams for details of how to connect the external current transformer, the external voltage transformer and the external reset (see [application example \[17\]](#)).
- ▶ Connect the output contacts in accordance with the relevant application circuit.

7.3 Application



NOTICE

Only connect the unit as shown in the examples below! Do not connect unlabelled terminals.

The following circuit examples are typical applications of the true power converter PMD s10.

With continuous currents of > 12 A the measuring current has to be measured via an external current transformer. With voltage > 500 V the voltage has to be measured via an external voltage transformer.

7.3.1 Circuit for three-phase motor

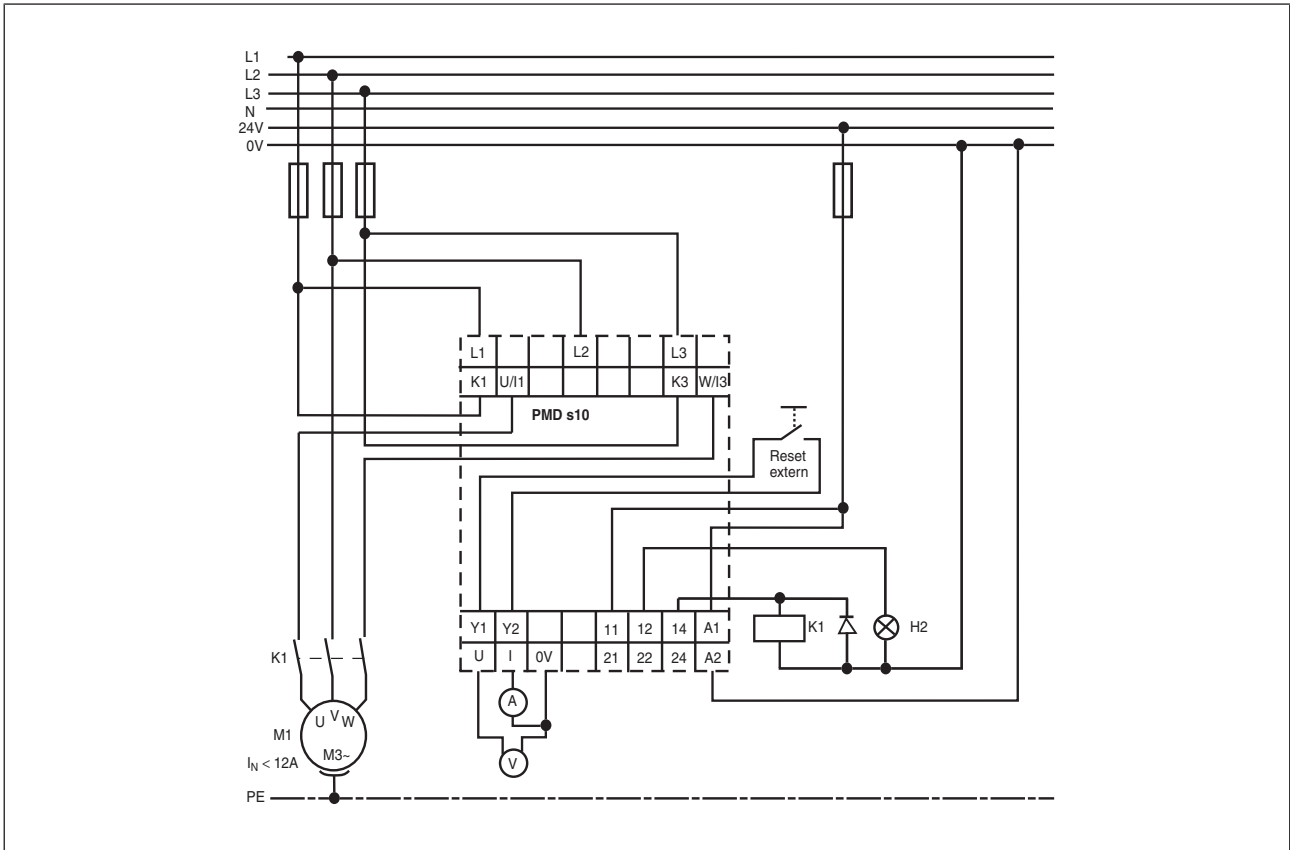

7.3.2 Circuit for three-phase motor with CT and VT

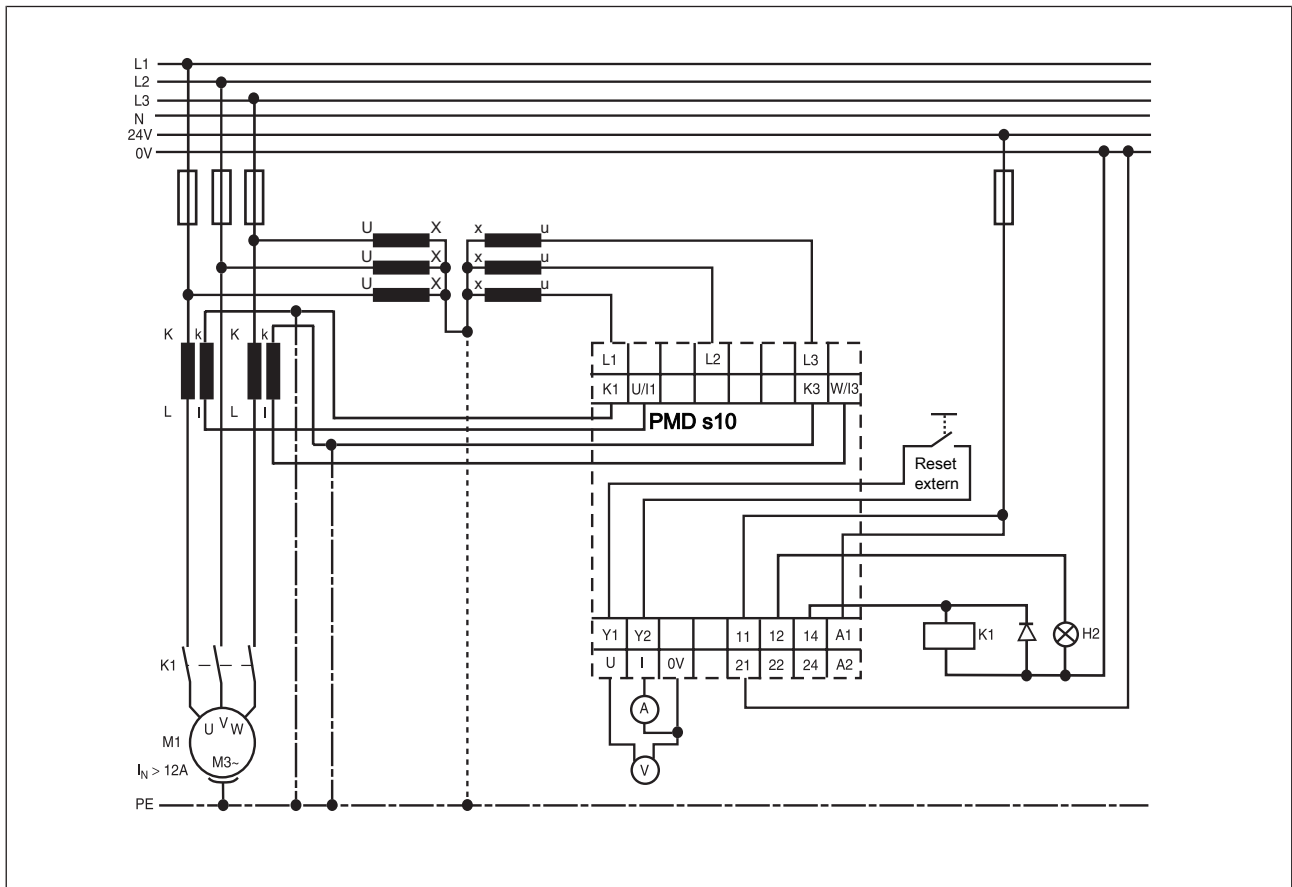

7.3.3 Circuit for motor (1 AC)

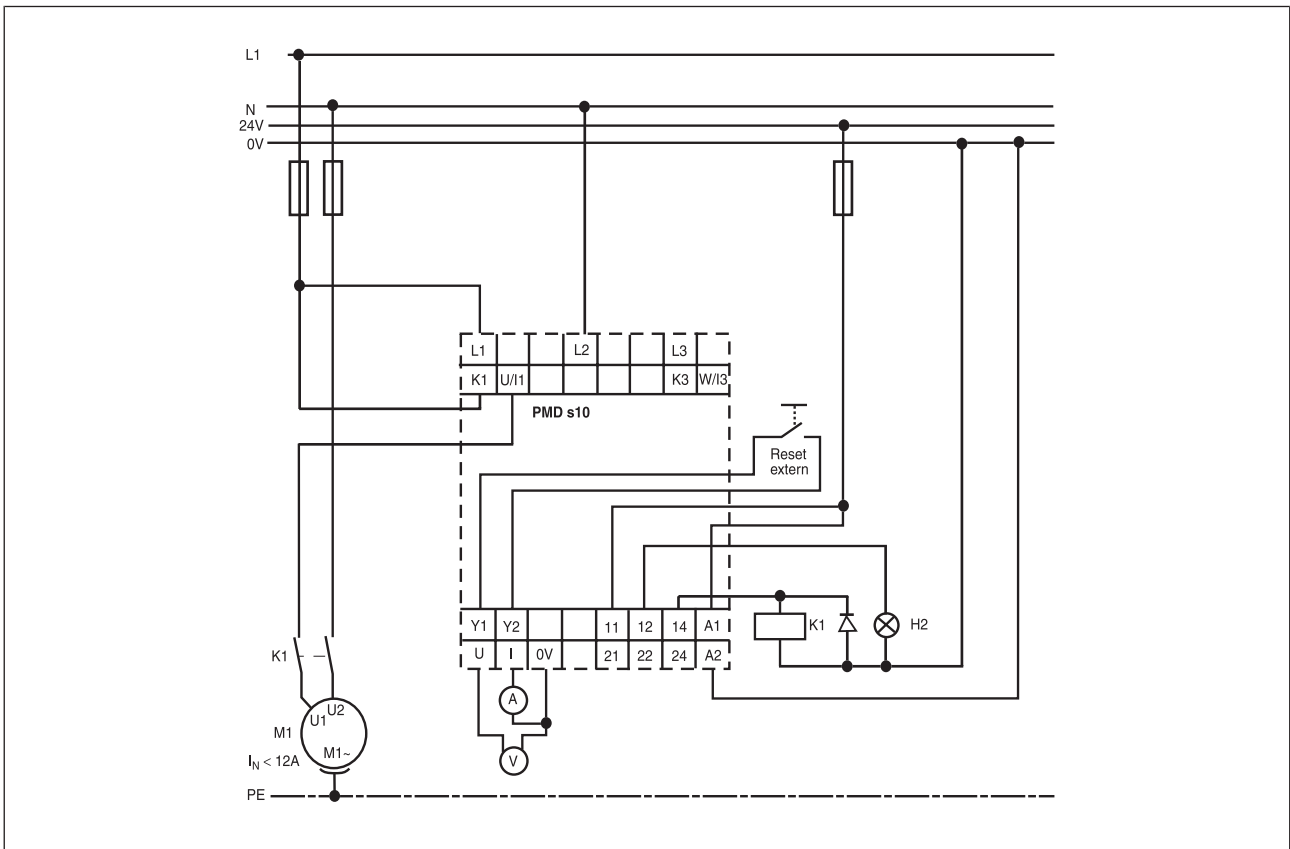

7.3.4 Circuit for motor (1 AC) with CT

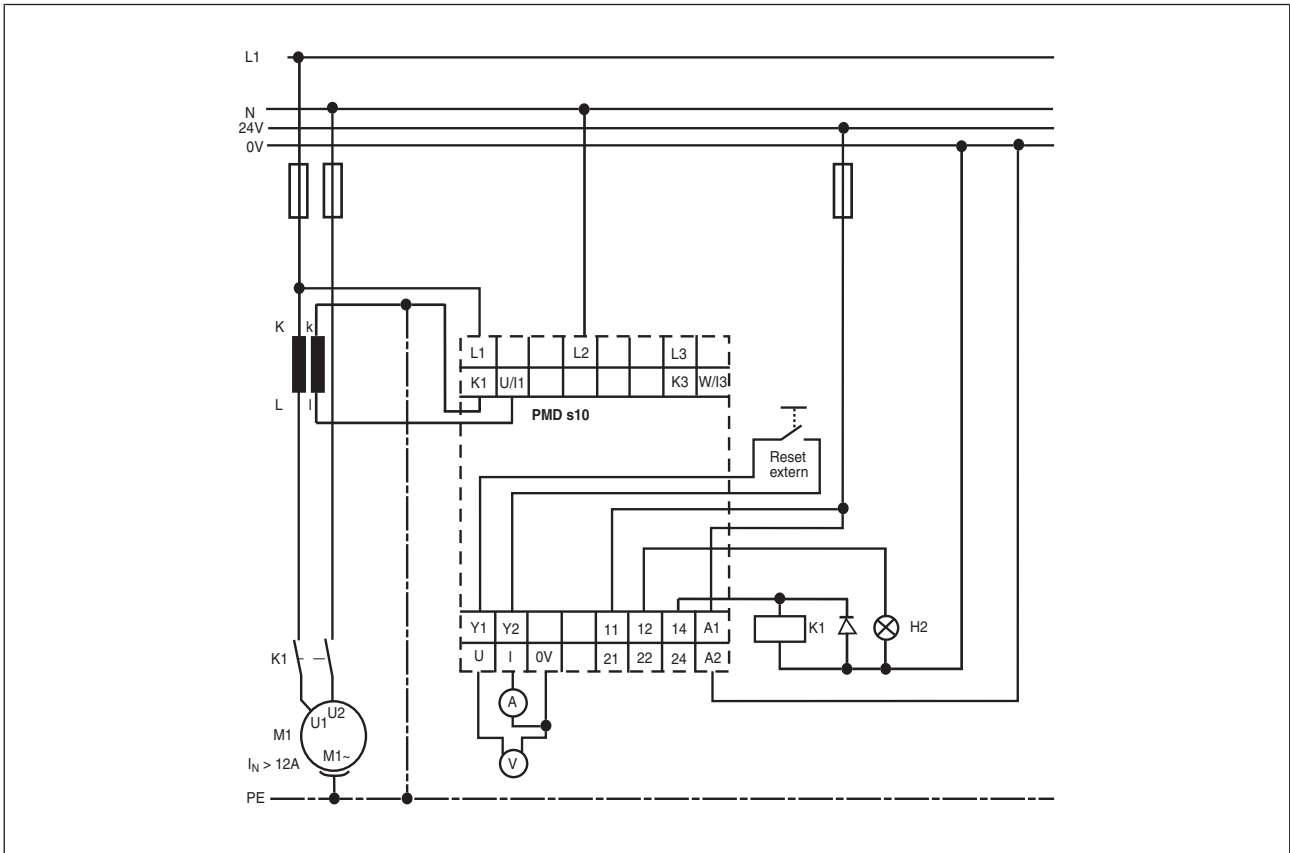

7.4 Read and set parameters

Some settings are required in the unit's menu in order to operate the unit. Before you start, make sure you know how to read values from the display and use the rotary knob to set parameters (see [Sample configuration \[28\]](#)).

7.5 Display menu - Configuration

7.5.1 Rotary knob

Function

The menu settings are made on the unit's display via a rotary knob. You have the option to make the settings on the knob by hand or with a screwdriver. If you make the settings with a screwdriver, the knob can remain within the unit.

Pull out and retract the knob

Knob :

- ▶ (A) pull out until it locks into position
- ▶ (B) release and push it back into the unit:
 - Press the bar on the side of the knob [1] towards the centre of the knob. This releases the knob.

– Press the knob downwards [2] while keeping the bar pressed in

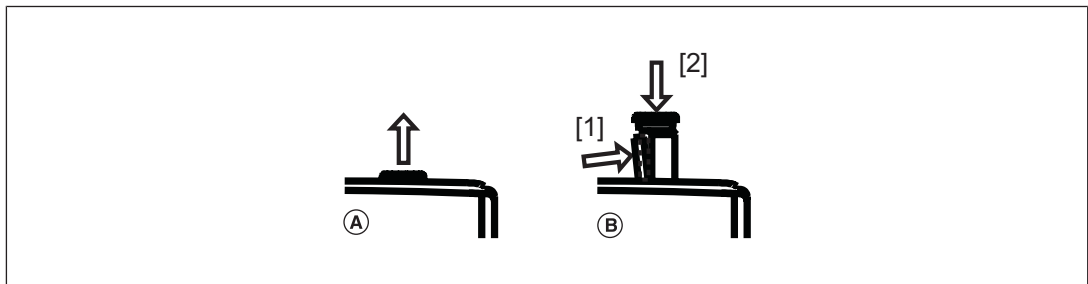

Rotate and press the knob



Rotate

- ▶ Select menu item
- ▶ Set the parameter/numeric value with the following rotational speed:
 - Slowly: Units
 - Quickly: Tens
 - Very quickly: Hundreds



Press

- ▶ Confirm selection/setting
- ▶ Switch to menu

7.5.2

Display

Display	Meaning
->	Value can be set
Power P	Parameter name
.... W	Value and unit



INFORMATION

Once an action has been taken in the menu, the display switches back to the default display if a value is not set or modified within 30 s. The current setting remains unchanged.

7.5.3

Use chip card

The parameters that are set on a unit can be stored on the chip card. The data is stored along with a device identifier. We recommend that you always operate the unit with a chip card.

- ▶ If the parameters on a unit have been changed due to an error, they can be restored using the backup copy from the chip card.
- ▶ If a unit requires maintenance or needs to be exchanged, the chip card can be used to download the parameters to another unit.



INFORMATION

If you operate the unit without a chip card, the "Fault" LED will light and the following message will appear once only: **Insert SIM Card**. If you change the parameters, the **Insert SIM Card** message will reappear.

When the chip card is inside the unit,

- ▶ the chip card is checked to verify the device identifier and ensure that the data is identical.
- ▶ Unit parameters are automatically saved to the chip card during operation. As a result, the chip card always contains a copy of the unit's current internal data. Exception: If you select **Write SIM? no**.

7.5.3.1

Insert chip card



NOTICE

The chip card contact is only guaranteed if the contact surface is clean and undamaged. For this reason please protect the chip card's contact surface from

- Contamination
- Contact
- Mechanical impact, such as scratches.



NOTICE

Switch off the product before inserting or exchanging the chip card.

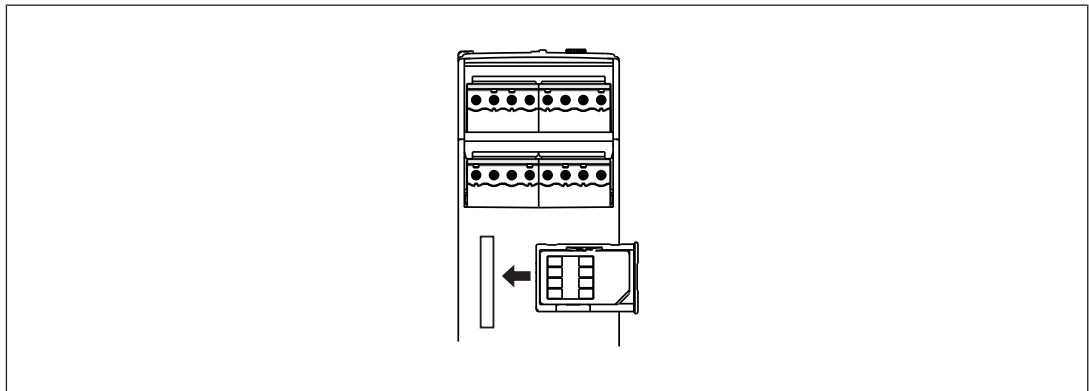

Make sure that you do not bend the chip card as you insert it into the chip card slot.



7.5.3.2 Write data to chip card

If you are inserting a chip card which has not yet been written by a PMD s10, you have the option to:

Allow data to be written to the chip card

Insert chip card		1. -> select		2.	Data is written to the chip card
Insert SIM Card	Write SIM? no		Write SIM? yes		Power P



Do not allow data to be written to the chip card

Insert chip card		1.			Data is not written to the chip card
Insert SIM Card	Write SIM? no				Insert SIM Card

7.5.3.3 Read data from chip card

If you are inserting a chip card which has not yet been written by a PMD s10, you have the option to:

Allow data to be read from the chip card

Insert chip card	Data on chip card different to data on unit	1. -> select		2.	Data is read into the unit
Power P	Load SIM? no		Load SIM? yes		Power P

Do not allow data to be read from the chip card

Insert chip card	Data on chip card different to data on unit	1.			Data is not read into the unit, data is written to the chip card
Power P	Load SIM? no				Power P

7.5.3.4 Transfer device parameters

You can transfer device parameters from one device to another using the chip card.

Proceed as follows:

- ▶ Remove chip card containing the data from unit 1.
- ▶ Insert chip card in unit 2.
- ▶ Confirm the message **Load SIM yes?**.
The data is transferred.

**INFORMATION**

Note that device parameters with data from device version 2.0 cannot be transferred to a unit with version 1.0. In this case the message appears

Write SIM no?

7.5.4 Menu overview

7.5.4.1 "Settings" menu and sub-menu

- ▶ Constant display parameter, to be shown on the display during operation
- ▶ Measuring range limit value (Pmax)
Maximum true power of the load. For limitation of the switching thresholds and Uout, Iout.
- ▶ Switching threshold for overload (Po)
- ▶ Switching threshold for underload (Pu)
- ▶ Start-up suppression time (tstart)
- ▶ Reaction time (tr)
- ▶ Reset mode

7.5.4.2 "Advanced Settings" menu and sub-menu

- ▶ Overload warning threshold (Pwo)
- ▶ Underload warning threshold (Pwu)
- ▶ Switching hysteresis (Hyst.)
Value for automatic reset of the fault status (see function diagram)
- ▶ Range selection for Uout
- ▶ Range selection for Iout
- ▶ Offset output voltage (Uoffset)
Selectable offset for the output voltage Uout
- ▶ Offset output current (Ioffset)
Selectable offset for the output current Iout
- ▶ Switching threshold allocation (Rel. K1)
Allocation of switching thresholds to auxiliary contact K1
- ▶ Switching threshold allocation (Rel. K2)
Allocation of switching thresholds to auxiliary contact K2
- ▶ Switching direction (Rel. K1)
Normally de-energised or energised mode for auxiliary contact K1
- ▶ Switching direction (Rel. K2)
Normally de-energised or energised mode for auxiliary contact K2
- ▶ External output Ext. CT)
Transmission ratio of the external current transformer; if there is no external current transformer set 1 : 1
- ▶ External voltage transformer (ext. VT)
Transmission ratio of the external current transformer; if there is no external current transformer set 1 : 1

- ▶ Load default values (Load Default)
Reset all parameters to the factory default settings

7.5.4.3

"Info" menu

- ▶ Operating hours (tOperate)
Operating hours of the PMD s10
- ▶ Operating hours load/generator (tLoad)
Operating hours of the load/generators; can be reset
- ▶ Max. voltage applied (Umax)
highest voltage to have been applied
- ▶ Max. current applied (Imax)
highest current to have been applied
- ▶ Cycles for relay K1 (K1 cycle)
- ▶ Cycles for relay K2 (K2 cycle)
- ▶ Software version (Software)

7.5.4.4 "Settings", "Advanced Settings" and "Info" menu (schematic representation)

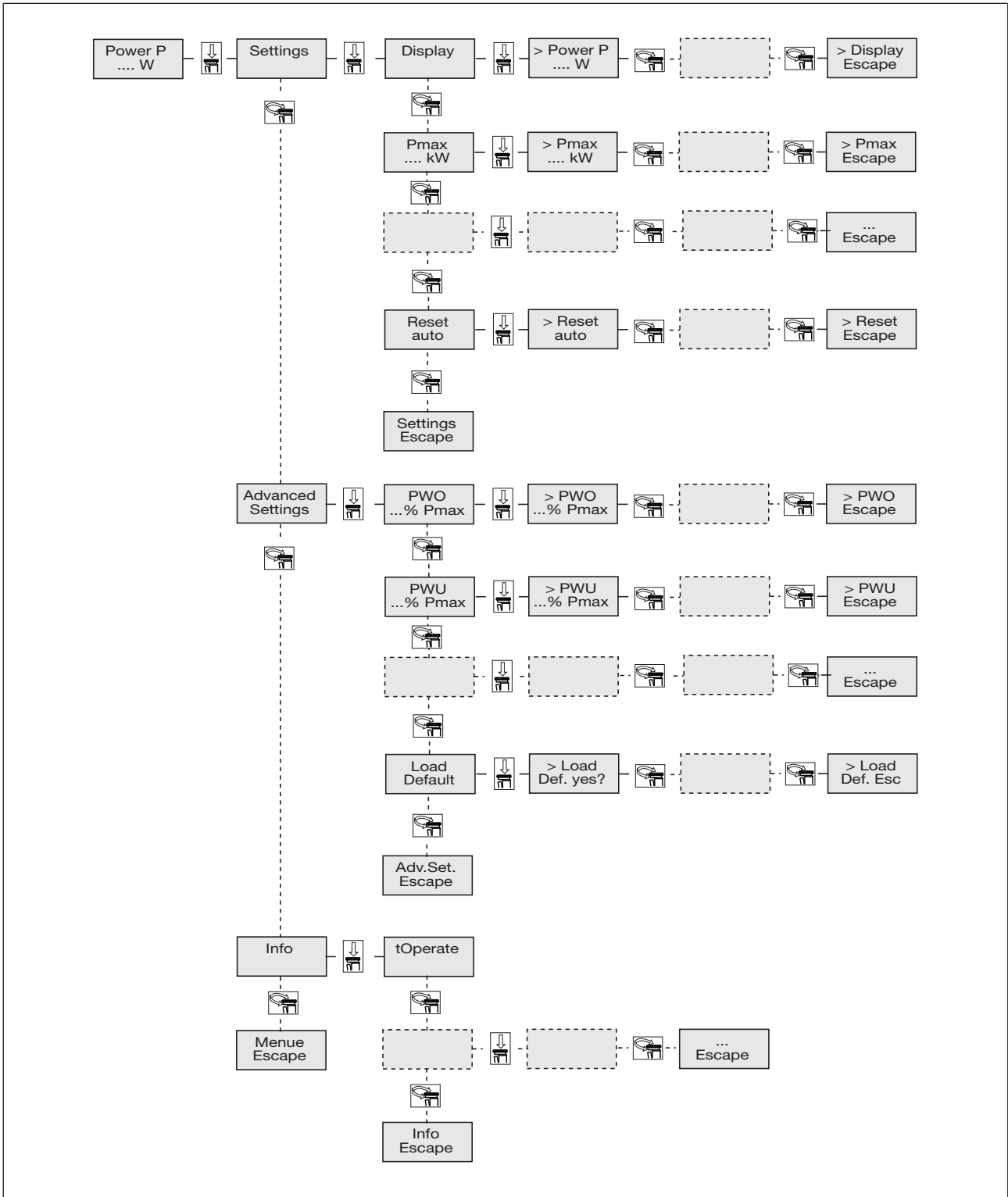

7.5.5 Set the parameter value

Set parameters "Settings" menu

Default value	Parameters can be set from ... to		Leave unchanged
Pmax 5.50 kW	-> Pmax 1.00 W	-> Pmax 11.5 KW	-> Pmax Escape
Po 80 % Pmax	-> Po 0% Pmax	-> Po 100 % Pmax	-> Po Escape
Pu 20 % Pmax	-> Pu 0% Pmax	-> Pu 100 % Pmax	-> Pu Escape
tstart 3.0 s	-> tstart 0.0 s	-> tstart 30.0 s	-> tstart Escape
tr 0.10 s	-> tr 0.00 s	-> tr 30.0 s	-> tr Escape
Reset auto	-> Reset auto	-> Reset manual	-> Reset Escape
			Settings Escape

Set parameters "Advanced Settings"

Default value	Parameters can be set from ... to		Leave unchanged
Pwo 70 % Pmax	-> Pwo 0 % Pmax	-> Pwo 100 % Pmax	-> Pwo Escape
Pwu 30 % Pmax	-> Pwu 0 % Pmax	-> Pwu 100 % Pmax	-> Pwu Escape
Hyst. 15 % Pmax	-> Hyst. 0 % Pmax	-> Hyst. 50 % Pmax	-> Hyst. Escape
Uout ± 10 V	-> Uout ± 10 V	-> Uout 10 ... 0 V	-> Uout Escape
Iout 4 ... 20 mA	-> Iout 4 ... 20 mA	-> Iout ± 20 mA	-> Iout Escape
Uoffset 0.0 V	-> Uoffset - 10.0 V	-> Uoffset + 10.0 V	-> Uoffset Escape
Ioffset 0.0 mA	-> Ioffset - 20.0 mA	-> Ioffset + 20.0 mA	-> Ioffset Escape
Rel. K1 Po	-> Rel. K1 Po	-> Rel. K1 Pu	...

Default value	Parameters can be set from ... to		Leave unchanged
...	-> Rel. K1 Po Pu	...	-> Rel. K1 Escape
Rel. K2 Pu	-> Rel. K2 Pu	-> Rel. K2 Pwo	...
...	-> Rel. K2 Pwu	-> Rel. K2 Pwo Pwu	-> Rel. K2 Escape
Rel. K1 norm. on	-> Rel. K1 norm. on	-> Rel. K1 norm. off	-> Rel. K1 Escape
Rel. K2 norm. on	-> Rel. K2 norm. on	-> Rel. K2 norm. off	-> Rel. K2 Escape
ext. CT 1 : 1	-> ext. CT 1 : 1	-> ext. CT 1000 : 1	-> ext. CT Escape
ext. VT 1 : 1	-> ext. VT 1 : 1	-> ext. VT 100 : 1	-> ext. VT Escape
Load Default	-> Load Def. Esc	-> Load Def. yes?	-> Default Loaded
			Adv. Set. Escape

7.6 Procedure for setting parameters



NOTICE

Ensure that the parameters are set correctly for PMD s10. True power overload or underload can damage machinery or disrupt process cycles. Simulate load cases once the parameters have been set!

This section describes the main procedure for setting the parameters. In the following pages, the procedure is described using real examples.

Setting the parameters:

- ▶ If the unit PMD s10 is connected to a current transformer and/or a voltage transformer, set the CT/VT transmission ratio (default setting: 1 : 1).
- ▶ Set the load's maximum true power Pmax:
 - Read the value on the type label or data sheet.
 - or: Operate the motor at the highest permitted load; read the current value on the display and set the Pmax.
- ▶ Set the switching threshold for overload Po.
- ▶ Operate the motor in normal mode.

- ▶ Set the switching threshold for underload P_u : Operate the motor at the lowest permitted load; read the current value on the display and set the switching threshold for the displayed value as a % of P_{max} .
- ▶ Set the start-up suppression time t_{start} : Restart the motor, monitor the output and measure the time it takes for the rated load to be displayed in normal mode. (Default setting: 3 s).
Set the start-up suppression time t_{start} so that the unit masks the start-up phase.
- ▶ Set the reaction time t_r : Set the reaction time t_r so that the unit does not react to transient overload or underload.
- ▶ Optional settings:
 - Manual or automatic reset
 - Display mode during operation



7.6.1 Example configuration

- ▶ P_{max} : 1.00 kW
- ▶ Current transformer: CT 10 : 1



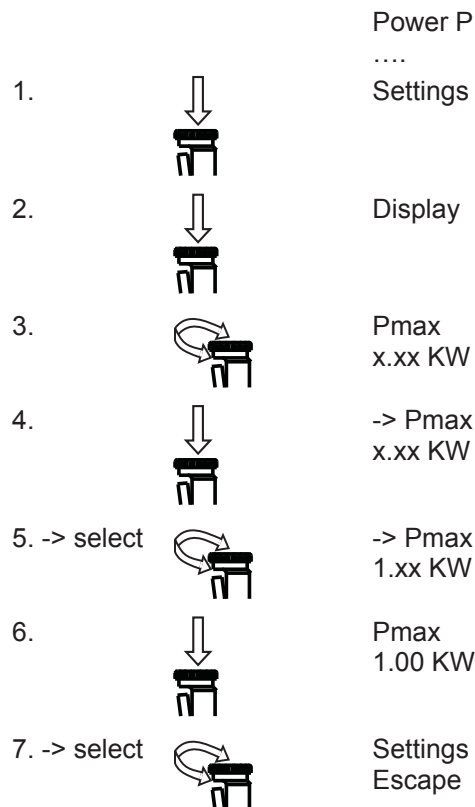







1. Set P_{max} : 1.00 KW

The settings for P_u , t_{start} , t_r and Reset can also be made in the "Settings" menu. The sequence of steps (1 ... 10) is the same.



- 8.  Settings
- 9. -> select  Menue
Escape
- 10.  Power P
....

2. Set current transformer: CT 10 : 1







- Power P
....
- 1.  Settings
- 2. -> select  Advanced Settings
- 3.  P_{wo}
70% Pmax
- 4.  ext. CT
1 : 1
- 5.  -> ext. CT
1 : 1
- 6. -> select  -> ext. CT
1 : 1
- 7.  ext. CT
10 : 1
- 8. -> select  Advanced Settings
Escape
- 9.  Advanced
Settings
- 10. -> select  Menue
Escape
- 11.  Power P
....

8 Operation

8.1 Status messages

LEDs indicate the status and errors during operation:

 LED on

LED status		Meaning
Power	 Green	Supply voltage is present, tOperate counts
> max	 Yellow	Overload switching threshold exceeded
< min	 Yellow	Underload switching threshold exceeded
Out 1	 Yellow	Switch status of auxiliary contact K1
Out 2	 Yellow	Switch status of auxiliary contact K2
Fault	 Red	Error message

8.1.1 Error messages

Display	LED on	Cause	Remedy
Error U > 550 V	Fault	UM too high U > 550 V	Reduce UM
Error I > 12 A	Fault	IM too high I > 12 A	Reduce IM or use current transformer (CT)
Warning P > Pmax	Fault	Pmax too low	Increase Pmax
Insert SIM Card	Fault	Chip card not inserted, not writable or defective	Insert or exchange chip card/
-	Power does not illuminate	No supply voltage	Check supply voltage

9 Technical details

General	760100	761100
Certifications	CE, cULus Listed	CE, cULus Listed
Electrical data	760100	761100
Supply voltage		
Voltage	24,0 - 240,0 V	24,0 - 240,0 V
Kind	AC/DC	AC/DC
Voltage tolerance	-20 %/+10 %	-20 %/+10 %
Output of external power supply (AC)	5,0 VA	5,0 VA
Output of external power supply (DC)	3,0 W	3,0 W
Frequency range AC	50 - 60 Hz	50 - 60 Hz
Duty cycle	100 %	100 %
External unit fuse protection F1 min.	1,00 A	1,00 A
External unit fuse protection F1 max.	Max. conductor cross section	Max. conductor cross section
Measuring circuit	760100	761100
Measuring voltage UM	100 - 550 V	100 - 550 V
Measuring current IM	1 - 12 A	1 - 12 A
Frequency range	0, 15 - 400 Hz	0, 15 - 400 Hz
Measuring range limit value (adjustable) CT/VT 1: 1	1,0 W - 11,5 kW	1,0 W - 11,5 kW
Performance range, current transformer 1A	1,5 - 7,5 VA	1,5 - 7,5 VA
Performance range, current transformer 5 A	2,5 - 15,0 VA	2,5 - 15,0 VA
Current transformer class	3	3
Max. measuring current AC/DC	12 A	12 A
Output signals during motor operation	760100	761100
Output voltage Uout	0 - 10 V	0 - 10 V
Output voltage Uout	10 - 0 V	10 - 0 V
Termination impedance (burden) Rout	1 kOhm	1 kOhm
Output current Iout	4 - 20 mA	4 - 20 mA
Output current Iout	0 - 20 mA	0 - 20 mA
Termination impedance (burden) Rout	0,5 kOhm	0,5 kOhm
Output signals during generator operation	760100	761100
Output voltage Uout	0 - -10 V	0 - -10 V
Output current Iout	0 - -20 mA	0 - -20 mA

Analogue outputs	760100	761100
Temperature coefficient	0,10 %/K	0,10 %/K
Relay outputs	760100	761100
Number of output contacts		
Auxiliary contacts (C/O)	2	2
Utilisation category		
In accordance with the standard	EN 60947-4-1	EN 60947-4-1
Utilisation category of auxiliary contacts		
AC1 at	240 V	240 V
Min. current	0,10 A	0,10 A
Max. current	5,0 A	5,0 A
Max. power	1200 VA	1200 VA
DC1 at	24 V	24 V
Min. current	0,10 A	0,10 A
Max. current	5,0 A	5,0 A
Max. power	120 W	120 W
Utilisation category		
In accordance with the standard	EN 60947-5-1	EN 60947-5-1
Utilisation category of auxiliary contacts		
AC15 at	230 V	230 V
Max. current	5,0 A	5,0 A
DC13 (6 cycles/min) at	24 V	24 V
Max. current	2,0 A	2,0 A
External contact fuse protection, safety contacts		
In accordance with the standard	EN 60947-5-1	EN 60947-5-1
External contact fuse protection, auxiliary contacts		
Blow-out fuse, quick	6 A	6 A
Blow-out fuse, slow	4 A	4 A
Circuit breaker 24 V AC/DC, characteristic B/C	4 A	4 A
Contact material	AgNi10	AgNi10
Times	760100	761100
Typ. reaction time, analogue output at DC	20 ms	20 ms
reaction time, analogue output at 15 ... 60 Hz	70 - 16 ms	70 - 16 ms
reaction time, analogue output at 60 ... 400 Hz	16 ms	16 ms
Reaction time t_r	0,01 - 30,00 s	0,01 - 30,00 s
Start-up suppression time t_{start}	0,0 - 30,0 s	0,0 - 30,0 s
Switch-on delay		
Typ. switch-on delay	700 ms	700 ms
Max. switch-on delay	900 ms	900 ms

Environmental data	760100	761100
Climatic suitability	EN 60068-2-78	EN 60068-2-78
Ambient temperature		
Temperature range	-10 - 55 °C	-10 - 55 °C
Storage temperature		
Temperature range	-25 - 85 °C	-25 - 85 °C
Condensation during operation	Not permitted	Not permitted
EMC	EN 61000-6-2, EN 61000-6-4	EN 61000-6-2, EN 61000-6-4
Vibration		
In accordance with the standard	EN 60068-2-6	EN 60068-2-6
Frequency	10,0 - 55,0 Hz	10,0 - 55,0 Hz
Amplitude	0,35 mm	0,35 mm
Airgap creepage		
In accordance with the standard	EN 60664-1	EN 60664-1
Overvoltage category	III / II	III / II
Pollution degree	2	2
Rated insulation voltage	300 V	300 V
Rated impulse withstand voltage	6,00 kV	6,00 kV
Rated impulse withstand voltage		
Supply voltage, auxiliary contacts, analogue output	4,0 kV	4,0 kV
Protection type		
Mounting area (e.g. control cabinet)	IP54	IP54
Housing	IP40	IP40
Terminals	IP20	IP20
Mechanical data	760100	761100
Mounting position	Any	Any
Mechanical life	10,000,000 cycles	10,000,000 cycles
Material		
Bottom	PC	PC
Front	PC	PC
Top	PC	PC
Connection type	Screw terminal	Cage clamp terminal
Mounting type	plug-in	plug-in
Conductor cross section with screw terminals		
1 core flexible	0,25 - 2,50 mm², 24 - 12 AWG	–
2 core with the same cross section, flexible with crimp connectors, no plastic sleeve	0,25 - 1,00 mm², 24 - 16 AWG	–
2 core with the same cross section, flexible without crimp connectors or with TWIN crimp connectors	0,20 - 1,50 mm², 24 - 16 AWG	–
Torque setting with screw terminals	0,50 Nm	–

Mechanical data	760100	761100
Conductor cross section with spring-loaded terminals: Flexible with/without crimp connector	–	0,20 - 2,50 mm², 24 - 12 AWG
Stripping length with spring-loaded terminals	–	9 mm
Dimensions		
Height	98,0 mm	100,0 mm
Width	45,0 mm	45,0 mm
Depth	120,0 mm	120,0 mm
Weight	340 g	370 g

Where standards are undated, the 2012-01 latest editions shall apply.

10 Order reference

Product type	Features	Connection type	Order no.
PMD s10	24 - 240 V AC/DC	With screw terminals	760 100
PMD s10 C	24 - 240 V AC/DC	With spring-loaded terminals	761 100

11 **EC declaration of conformity**

This/(These) product(s) fulfil the requirements of the low voltage directive 2006/95/EG. The complete EC Declaration of Conformity is available on the Internet at www.pilz.com/downloads.

Representative: Norbert Fröhlich, Pilz GmbH & Co. KG, Felix-Wankel-Str. 2, 73760 Ostfildern, Germany

► Support

Technical support is available from Pilz round the clock.

Americas

Brazil
+55 11 97569-2804

Canada
+1 888 315 7459

Mexico
+52 55 5572 1300

USA (toll-free)
+1 877-PILZUSA (745-9872)

Asia

China
+86 21 60880878-216

Japan
+81 45 471-2281

South Korea
+82 31 778 3300

Australia

+61 3 95600621

Europe

Austria
+43 1 7986263-0

Belgium, Luxembourg
+32 9 3217570

France
+33 3 88104003

Germany
+49 711 3409-444

Ireland
+353 21 4804983

Italy, Malta
+39 0362 1826711

Scandinavia

+45 74436332

Spain

+34 938497433

Switzerland

+41 62 88979-32

The Netherlands

+31 347 320477

Turkey

+90 216 5775552

United Kingdom

+44 1536 462203

You can reach our international hotline on:

+49 711 3409-444
support@pilz.com

Pilz develops environmentally-friendly products using ecological materials and energy-saving technologies. Offices and production facilities are ecologically designed, environmentally-aware and energy-saving. So Pilz offers sustainability, plus the security of using energy-efficient products and environmentally-friendly solutions.

*Energy
saving by Pilz*



We are represented internationally. Please refer to our homepage www.pilz.com for further details or contact our headquarters.

Headquarters: Pilz GmbH & Co. KG, Felix-Wankel-Straße 2, 73760 Ostfildern, Germany
Telephone: +49 711 3409-0, Telefax: +49 711 3409-133, E-Mail: info@pilz.com, Internet: www.pilz.com

PILZ
THE SPIRIT OF SAFETY

22092-EN-05, 2019-07 Printed in Germany
© Pilz GmbH & Co. KG, 2019

CECE®, CHRE®, CMSE®, InduraNET p®, Leansafe®, Master of Safety®, Master of Security®, PAS4000®, PAScall®, PASconfig®, Pilz®, PTT®, PLID®, PMCPirimo®, PMCPiritego®, PMCTendo®, PMD®, PMJ®, PNOZ®, PRBT®, PRCM®, PRCM®, PSEN®, PSS®, PVS®, SafetyBUS p®, SafetyEYE®, SafetyNET p®, THE SPIRIT OF SAFETY® are registered and protected trademarks of Pilz GmbH & Co. KG in some countries. We would point out that product features may vary from the details stated in this document, depending on the status at the time of publication and the scope of the equipment. We accept no responsibility for the validity, accuracy and entirety of the text and graphics presented in this information. Please contact our Technical Support if you have any questions.