



Visualisation; Diagnostics

Easy to Configure

Programming IEC 61131-3

Rapid Installation

PDP67 PN 6FDI 6FDIO 2FDOTP

PILZ

THE SPIRIT OF SAFETY

► Decentralised field devices

This document is the original document.

Where unavoidable, for reasons of readability, the masculine form has been selected when formulating this document. We do assure you that all persons are regarded without discrimination and on an equal basis.

All rights to this documentation are reserved by Pilz GmbH & Co. KG. Copies may be made for the user's internal purposes. Suggestions and comments for improving this documentation will be gratefully received.

Pilz®, PIT®, PMI®, PNOZ®, Primo®, PSEN®, PSS®, PVIS®, SafetyBUS p®, SafetyEYE®, SafetyNET p®, the spirit of safety® are registered and protected trademarks of Pilz GmbH & Co. KG in some countries.



SD means Secure Digital

1	Introduction	6
1.1	Validity of documentation	6
1.2	Using the documentation	6
1.3	Definition of symbols	6
1.4	Third-party manufacturer licence information	7
2	Overview	8
2.1	Unit features	8
2.2	Front view	11
2.3	Scope of supply	12
3	Safety	13
3.1	Intended use	13
3.2	Safety regulations	13
3.2.1	Use of qualified personnel	13
3.2.2	Warranty and liability	14
3.2.3	Disposal	14
3.3	System requirements	14
4	Security	15
4.1	Implemented security measures	15
4.2	Required security measures	15
5	Function description	17
5.1	IO area	18
5.1.1	Digital FS inputs	18
5.1.1.1	Test pulse outputs	27
5.1.2	Digital outputs	29
5.1.2.1	ST outputs	29
5.1.2.2	1-pole FS outputs	29
5.1.2.3	2-pole FS outputs	34
5.2	Device area	40
5.2.1	Integrated protection mechanisms	40
5.2.2	Reset button	40
5.2.3	PDP67 removable data medium (available as an option)	41
5.3	Supply voltages	44
5.4	PROFINET with PROFIsafe	46
5.4.1	MAC addresses	46
5.4.2	Setting the IP address	46
5.4.3	Setting the F-address	46
5.4.4	Deactivation and reactivation	47
5.4.5	Substitute values	47
5.4.6	Projects	48
5.4.7	Process image	49
5.4.8	Device identification	51
5.5	Derating diagram	51
5.6	Reaction times	53

6	Web application	55
6.1	Pre-defined user name	55
6.2	Logging in to the web application	56
6.2.1	Certificates	56
6.3	Start page	59
6.4	Display diagnostics	61
6.5	Configuring the network	63
6.6	Performing the wiring test	64
6.7	Managing users	67
6.8	Settings	68
6.8.1	Managing certificates	69
6.8.2	Adapting the data protection and security information	69
6.8.3	Deactivating the web application	69
6.9	Support	70
7	Installation	71
7.1	General installation guidelines	71
7.1.1	Dimensions	72
7.1.2	Installing the device	72
8	Wiring	75
8.1	General wiring guidelines	75
8.2	Connector pin assignment	77
8.3	Connecting the supply voltage	79
8.4	Connecting the functional earth	82
8.5	Connecting the fieldbus	82
8.6	Wiring examples	83
8.6.1	2-channel safety switch	83
8.6.2	1-channel actuators	85
9	Operation	87
9.1	Display elements	87
9.1.1	MS	88
9.1.2	PWR	88
9.1.3	SD	89
9.1.4	ETH0 (X21), ETH1 (X22)	89
9.1.5	RUN	89
9.1.6	DIAG	90
9.1.7	SO - Safe Operation	90
9.1.8	LEDs at the IO ports of the inputs and outputs	90
9.2	Diagnostics	91
9.2.1	Read diagnostic log	91
9.2.2	Remedies	91
10	Maintenance and testing	92
11	Technical details	93
11.1	Safety characteristic data	97

12	Supplementary data	98
12.1	Network data	98
12.2	EC declaration of conformity	99
12.3	UKCA-Declaration of Conformity	99
13	Order reference	100
13.1	Product.....	100
13.2	Accessories.....	100
14	Appendix	106
14.1	Establishing the F-address (PROFINET with PROFIsafe).....	106

1 Introduction

1.1 Validity of documentation

This documentation is valid for the product PDP67 PN 6FDI 6FDIO 2FDOTP from Version HW 2.0, FW 1.1.x.

This operating manual explains the function and operation, describes the installation and provides guidelines on how to connect the product.

1.2 Using the documentation

This document is intended for instruction. Only install and commission the product if you have read and understood this document. The document should be retained for future reference.

1.3 Definition of symbols

Information that is particularly important is identified as follows:



DANGER!

This warning must be heeded! It warns of a hazardous situation that poses an immediate threat of serious injury and death and indicates preventive measures that can be taken.



WARNING!

This warning must be heeded! It warns of a hazardous situation that could lead to serious injury and death and indicates preventive measures that can be taken.



CAUTION!

This refers to a hazard that can lead to a less serious or minor injury plus material damage, and also provides information on preventive measures that can be taken.



NOTICE

This describes a situation in which the product or devices could be damaged and also provides information on preventive measures that can be taken. It also highlights areas within the text that are of particular importance.



INFORMATION

This gives advice on applications and provides information on special features.

1.4 Third-party manufacturer licence information

This product includes Open Source software with various licenses.

More detailed information is available by calling up the menu **Support** → **Third-party manufacturer licences** in the web application of the PDP67 PN 6FDI 6FDIO 2FDOTP.

2 Overview

2.1 Unit features

Application of the product PDP67 PN 6FDI 6FDIO 2FDOTP:

Device with IO ports for use in a rugged industrial environment up to protection type IP67, to connect the system to PROFINET with PROFINET safe profile.

The product has the following features:

- ▶ PROFINET interface with PROFINET safe profile
- ▶ PROFINET Conformance Class C
- ▶ Supports IRT/ RT
- ▶ Data set I&M 0-4
- ▶ Web application with the following functions:
 - Display device information
 - Display diagnostics
 - Display and configure network settings
 - Perform a wiring test
- ▶ Up to **12** type 1/3 FS inputs in accordance with IEC 61131-2 distributed over 6 ports (X01 ... X06) when ports X02, X04, X06 are configured as FS inputs (default configuration)
- ▶ Up to **6** 1-pole digital FS outputs distributed over 3 ports when ports X02, X04, X06 are configured as FS outputs
- ▶ Up to **12** 1-pole ST outputs distributed over 6 ports when ports X01 ... X06 are configured as ST outputs
- ▶ **2** 2-pole digital FS outputs distributed over 2 ports (X07, X08)
- ▶ Properties of FS inputs:
 - Configurable input filter time: 0 ... 10.0 ms
 - Configurable pulse stretching: 0 ... 255 ms
 - Configurable discrepancy monitoring 10 ... 30000 ms
 - Configurable switch-on delay time 0 ... 5000 ms
 - Configurable bounce monitoring time 1 ... 30 s
- ▶ Properties of test pulse outputs:
 - Current load capacity: 0.5 A
 - Semiconductor technology
 - Overload-proof
 - Configurable max. test pulse duration: 0.3 ... 10.0 ms
 - Short circuit-proof
 - Can be configured either as:
 - Test pulse outputs (default configuration)
 - ST outputs
 - Voltage outputs (24 VDC)

Switched-off outputs

- ▶ Properties of ST outputs:
 - Current load capacity per output: 0.5 A
 - Semiconductor technology
 - 1-pin
 - Positive-switching
 - Short circuit-proof
- ▶ Properties of 1-pole FS outputs:
 - Current load capacity per output: 2 A
 - Semiconductor technology
 - 1-pin
 - Positive-switching
 - Short circuit-proof
 - Overload-proof
 - Configurable switch-off delay
 - Configurable on/off tests
 - Configurable repetition time of the on tests
- ▶ Properties of 2-pole FS outputs:
 - Current load capacity: 2 A
 - Semiconductor technology
 - Switches to 24 V (O0+) and 0 V (O0-)
 - Short circuit-proof
 - Overload-proof
 - Free from feedback
 - Configurable open circuit detection
 - Configurable switch-off delay
 - Configurable maximum test duration
 - Configurable repetition time of the advanced on tests
- ▶ Optional PDP67 removable data medium for a microSD card to store the device project and naming data
- ▶ Reset button
 - For original reset
 - For warm reset
 - To transfer the naming data and/or device project from the microSD card to the device memory

- ▶ LEDs for:
 - Switch status per input/output
 - Status display of the device
- ▶ LEDs for:
 - PROFINET status
 - PROFIsafe status

2.2 Front view

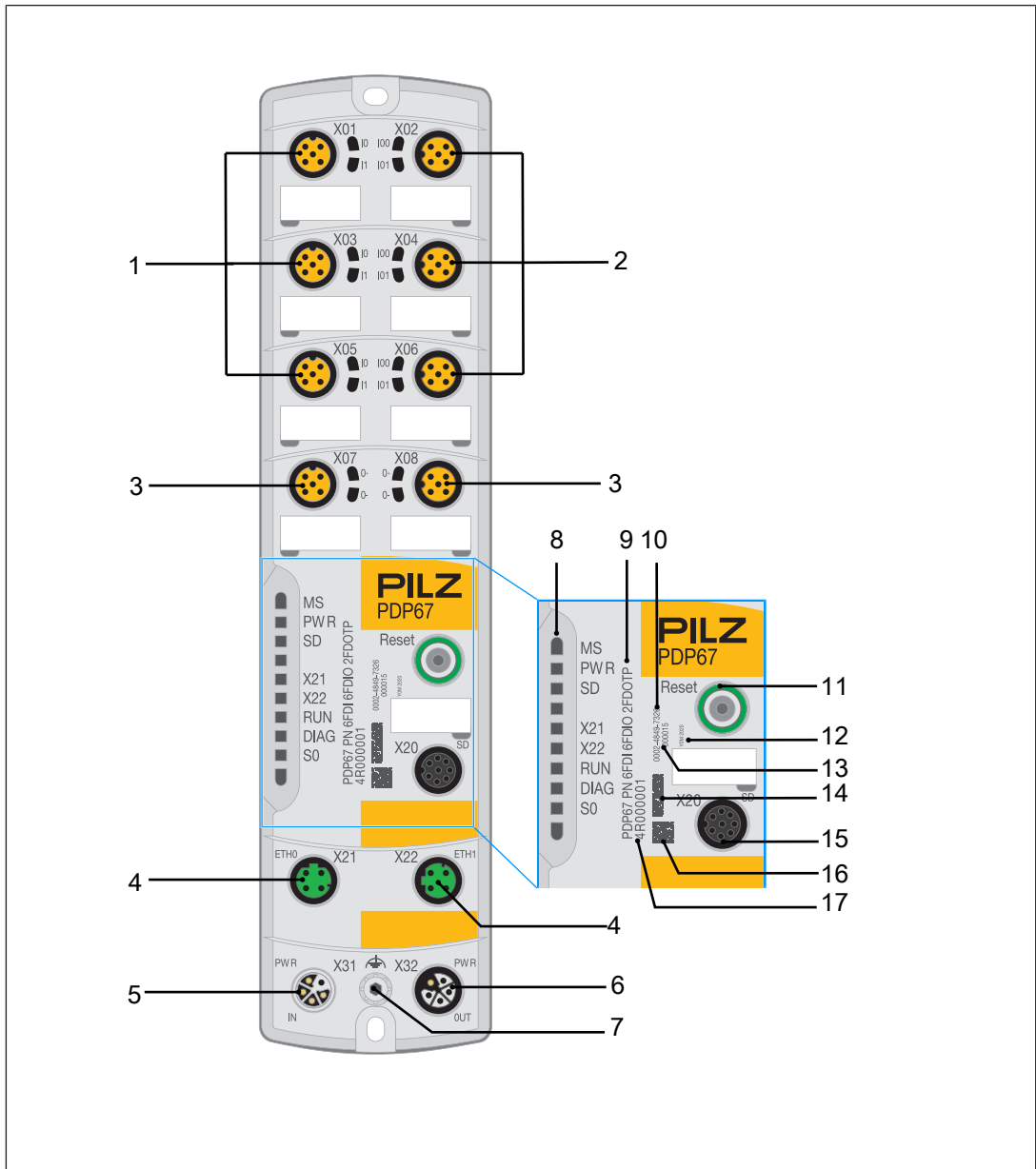

Fig.: Front view PDP67 PN 6FDI 6FDIO 2FDOTP

Legend

- 1 Ports X01, X03, X05
 - ▶ Type FDI: 2 FS inputs
 - ▶ Type SDO: ST outputs
- 2 Hybrid ports X02, X04, X06
 - ▶ Type FDIO: 2 FS inputs or 2 FS outputs, 1-pole
 - ▶ Type SDO: ST outputs
- 3 Ports X07, X08
 - ▶ Type FDOTP: FS outputs, 2-pole

- 4 Ports X21, X22
 - ▶ Type ETH0 / ETH1: Fieldbus interface for PROFINET with PROFI-safe profile
- 5 Port X31
 - ▶ Type PWR: Supply voltage connection
- 6 Port X32
 - ▶ Type PWR: Connection for forwarding the supply voltage
- 7 Functional earth connection
- 8 Status LEDs
- 9 Product name
- 10 Field for MAC address
- 11 Reset button
- 12 Field for year of manufacture
- 13 Field for serial number
- 14 Field for 2D code 11x2.5 mm
- 15 Connection for PDP67 removable data medium
- 16 Field for 2D code 5x5 mm
- 17 Order number

2.3 Scope of supply

- ▶ PDP67 device PDP67 PN 6FDI 6FDIO 2FDOTP with:
 - End cap for the PDP67 removable data medium connection (installed)
 - End cap for the reset button (installed)
 - 2 x M4 locking washers for the functional earth (installed)
 - 1 x M4 screw for the functional earth (installed)
 - Grounding strap (enclosed)
 - End cap for connector X31 (installed)

3 Safety

3.1 Intended use

The device PDP67 PN 6FDI 6FDIO 2FDOTP is suitable for use in a rugged industrial environment up to protection type IP67. It may not be used in a potentially explosive area.

Protection type IP67 is only guaranteed if open plugs and sockets are sealed with end caps.

The device is intended for use in

- ▶ Safety-related applications with
 - PROFINET with PROFI-safe profile
- ▶ Non-safety-related applications with
 - PROFINET

Intended use includes making the electrical installation EMC-compliant. The device is designed for use in an industrial environment. Interference may occur if used within a domestic environment.

The following is deemed improper use in particular

- ▶ Any component, technical or electrical modification to the device,
- ▶ Use of the device outside the areas described in this operating manual,
- ▶ Any use of the device that is not in accordance with the technical details.

Guidelines for UL approval

UL Markings

- ▶ If the equipment is used in a manner not specified by the manufacturer, the protection provided by the equipment may be impaired.

3.2 Safety regulations

3.2.1 Use of qualified personnel

The products may only be assembled, installed, programmed, commissioned, operated, maintained and decommissioned by persons who are competent to do so.

A competent person is a qualified and knowledgeable person who, because of their training, experience and current professional activity, has the specialist knowledge required. To be able to inspect, assess and operate devices, systems and machines, the person has to be informed of the state of the art and the applicable national, European and international laws, directives and standards.

It is the company's responsibility only to employ personnel who

- ▶ Are familiar with the basic regulations concerning health and safety / accident prevention,
- ▶ Have read and understood the information provided in the section entitled Safety
- ▶ Have a good knowledge of the generic and specialist standards applicable to the specific application.

3.2.2 Warranty and liability

All claims to warranty and liability will be rendered invalid if:

- ▶ The product was used contrary to the purpose for which it is intended
- ▶ Damage can be attributed to not having followed the guidelines in the manual or
- ▶ Operating personnel are not suitably trained.

3.2.3 Disposal

- ▶ In safety-related applications, please comply with the mission time T_M in the safety-related characteristic data.
- ▶ When decommissioning, please comply with local regulations regarding the disposal of electronic devices (e.g. Electrical and Electronic Equipment Act).

3.3 System requirements



INFORMATION

The device is supported by

- ▶ PASconfig from version 5.1.0
 - We recommend that you always use the latest version (download from www.pilz.com).



INFORMATION

Always use the latest version of the MDF file (module description file) (download from www.pilz.com).

An MDF file for the module must be available in the configuration tool PASconfig in order to use the module. The version of the MDF file is displayed in the MDF library and also supports all older modules. An MDF file contains multiple firmware versions to enable it to support older modules. It is important that the firmware version selected in PASconfig matches the firmware version on the connected system (see PASconfig online help, select "Firmware version for configuration").

4 Security

To secure plants, systems, machines and networks against cyberthreats it is necessary to implement (and continuously maintain) an overall industrial security concept that is state of the art.

Perform a risk assessment in accordance with VDI/VDE 2182 or IEC 62443-3-2 and plan the security measures with care. If necessary, seek advice from Pilz Customer Support.

4.1 Implemented security measures

- ▶ The web application is protected against unauthorised access by a password prompt.
- ▶ The password is saved in an encrypted format.
- ▶ If a password is changed, you will be prompted to enter the old password for authentication.
- ▶ A user will automatically be logged out of the web application after a session duration of 24 hours.
- ▶ A user will automatically be logged out of the web application after 10 minutes of inactivity.
- ▶ Defend against CSRF attacks (Cross-Site Request Forgery) by assigning a unique token to a session.
- ▶ No firmware downgrades are allowed. This prevents outdated firmware with vulnerabilities from being loaded onto the product.

4.2 Required security measures

- ▶ The configuration computer that accesses the product has to be protected from attacks by a firewall or other suitable measures. We recommend that a virus scanner is used on this configuration computer and updated regularly.
- ▶ If necessary, protect the configuration computer and the product from unauthorised use by assigning passwords and taking further measures if required. We also recommend that the user logged on to this configuration computer does not have administrator rights.
- ▶ Ensure that the product is separated by a router (layer 3 switch or firewall) from the company network.
- ▶ Only assign strong passwords and handle the passwords carefully. Be guided by generally accepted guidelines such as NIST 800-63b for example.
- ▶ As soon as possible, install firmware updates that Pilz provides for the product.
- ▶ Log data may contain personal data. Only store exported logs on a storage medium that is adequately protected.
- ▶ Use only one USB memory from a secure source. A manipulated USB memory could compromise the system.

- ▶ Before disposal, the product must be safely decommissioned. To do this, all the data must be deleted from the device.
 - Set the configuration back to its default settings or delete the configuration.
 - Switch off the product.
 - If the product includes a removable data medium, remove it and format it at the computer. Do not carry out a quick formatting. Alternatively, you can use a program to safely delete data or destroy the memory mechanically.

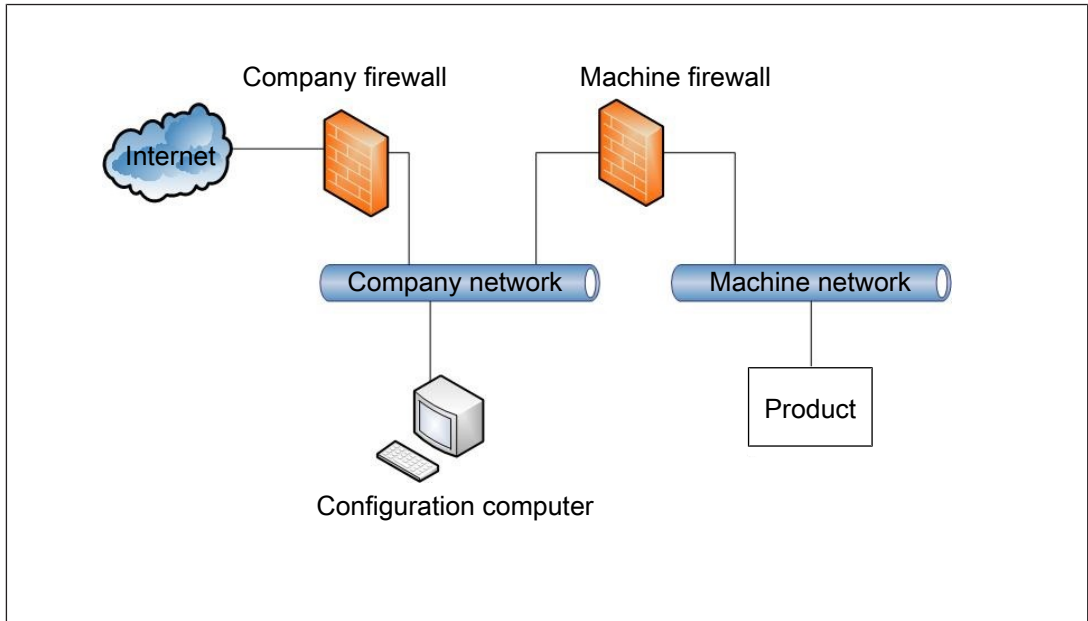

Fig.: Example network topology

- ▶ Note the [network data](#) [📖 98] for risk analysis and the security measures.

5 Function description

Structure of the PDP67 device:

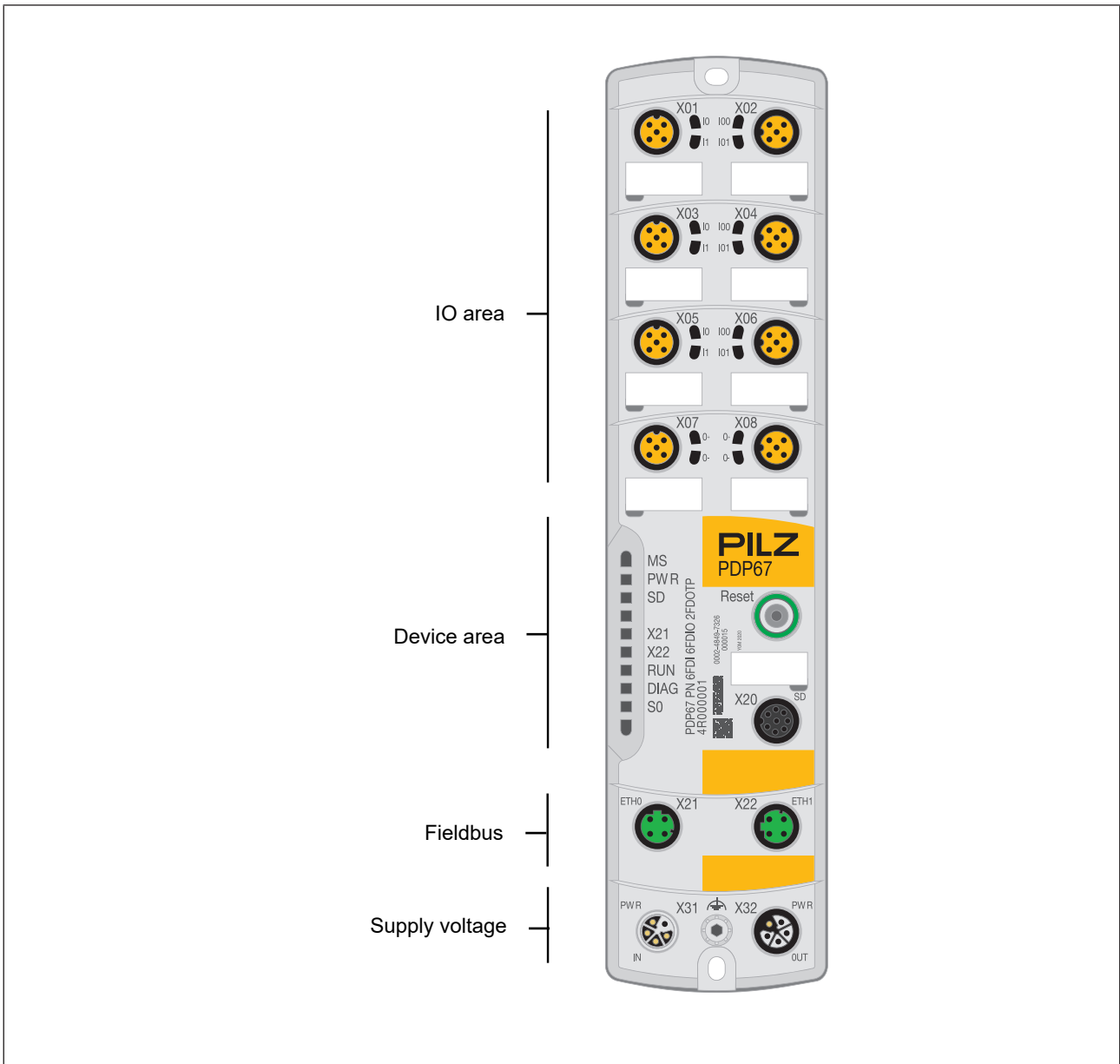





Fig.: Device structure

- ▶ **IO area**  18]:
 - I/O ports (X01 ... X08)
 - Status LEDs of IO ports
 - Replaceable inscription labels for the IO ports
- ▶ **Device area**  40]:
 - Reset button with label
 - Port for connecting the PDP67 removable data medium (X20)
 - Device status LEDs
 - Replaceable inscription label for the device

- ▶ [PROFINET with PROFIsafe](#)  46]:
 - 2 PROFINET ports (X21, X22)
- ▶ [Supply voltages](#)  44]:
 - 1 port to feed the supply voltage (X31)
 - 1 port to distribute the supply voltage (X32)
 - Functional earth connection

5.1 IO area

In its default configuration the device has 12 FS inputs and two 2-pole FS outputs. The IO ports named X02, X04, X06 can be used as an FS input or FS output, depending on the configuration. These IO ports are called hybrid IO ports.

5.1.1 Digital FS inputs

Depending on the configuration, the device has up to 12 type 1/3 FS inputs in accordance with IEC 61131-2, distributed over 6 IO ports. Contact-based sensors (e.g. safety gate switches) or electronic sensors with 24 V semiconductor outputs can be connected to the inputs.

The device can detect the following errors at the inputs:

- ▶ Shorts between the inputs and short circuits to 24 V (see [Test pulse outputs](#)  27])
- ▶ Discrepancy error

Signal requirements at the inputs:

- ▶ The signals must be present at the input for longer than the hardware filter time + the configured software filter time.

Functions

Configuration options for the FS inputs

Configurable properties	Configurable values	Default value
Pin state	<ul style="list-style-type: none"> ▶ Activated ▶ Deactivated 	Activated
Software filter time	0 ... 10 ms	1 ms
Pulse stretching	0 ... 255 ms	0 ms
Use discrepancy monitoring	<ul style="list-style-type: none"> ▶ Activated ▶ Deactivated 	Deactivated
Reintegration after discrepancy time	<ul style="list-style-type: none"> ▶ With restart interlock ▶ Without restart interlock 	With restart interlock
Sensor type	<ul style="list-style-type: none"> ▶ Non-equivalent ▶ Equivalent 	Non-equivalent
Discrepancy behaviour	<ul style="list-style-type: none"> ▶ Set value to zero ▶ Keep last valid value 	Set value to zero

Configurable properties	Configurable values	Default value
Discrepancy time	30 ... 30000 ms	100 ms
Switch-on delay time	0 ... 5000 ms	0 ms
Bounce monitoring time	1 ... 30 s	5 s
Test pulse	<ul style="list-style-type: none"> ▶ T0 ▶ T1 	<ul style="list-style-type: none"> ▶ I0: T0 ▶ I1: T1

Pin state

A digital input can be deactivated. If the digital input is deactivated, then the input will not be read. The process image of inputs for the deactivated input and the valid bit have the value FALSE "0". The LEDs for the input are switched off.

Software filter time

The software filter time can be configured for the inputs. When a filter time is configured, the value read at the input will not be forwarded to the process image of inputs until the filter time has elapsed.

Pulse stretching

The device stretches a "1" signal or "0" signal at the pins to the configured pulse stretch time $t_{stretch}$. If the signal is longer than the pulse stretch time, then it is not stretched any further.

Signal requirements at the inputs:

The 0-signal and the subsequent 1-signal together must be present at the input for longer than twice the configured pulse stretch time $t_{stretch}$.

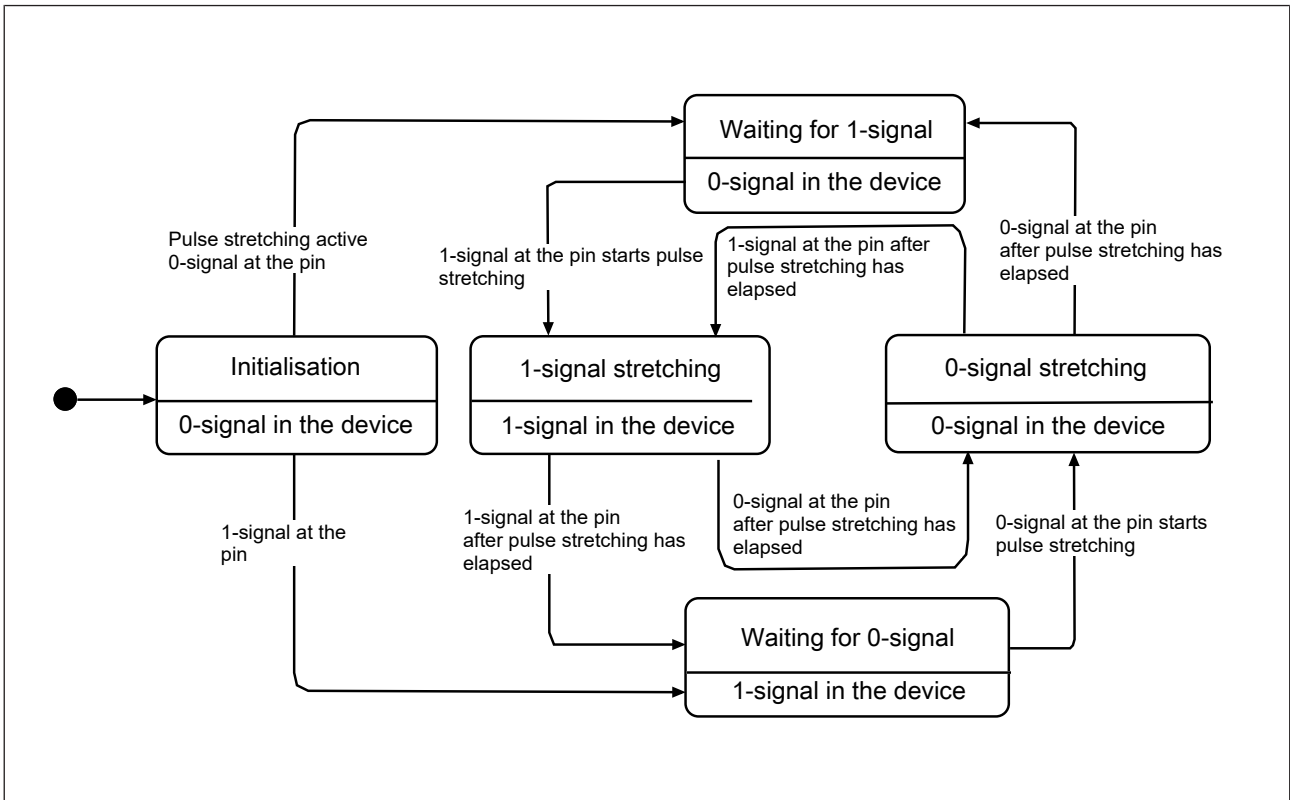

Fig.: States for pulse stretching

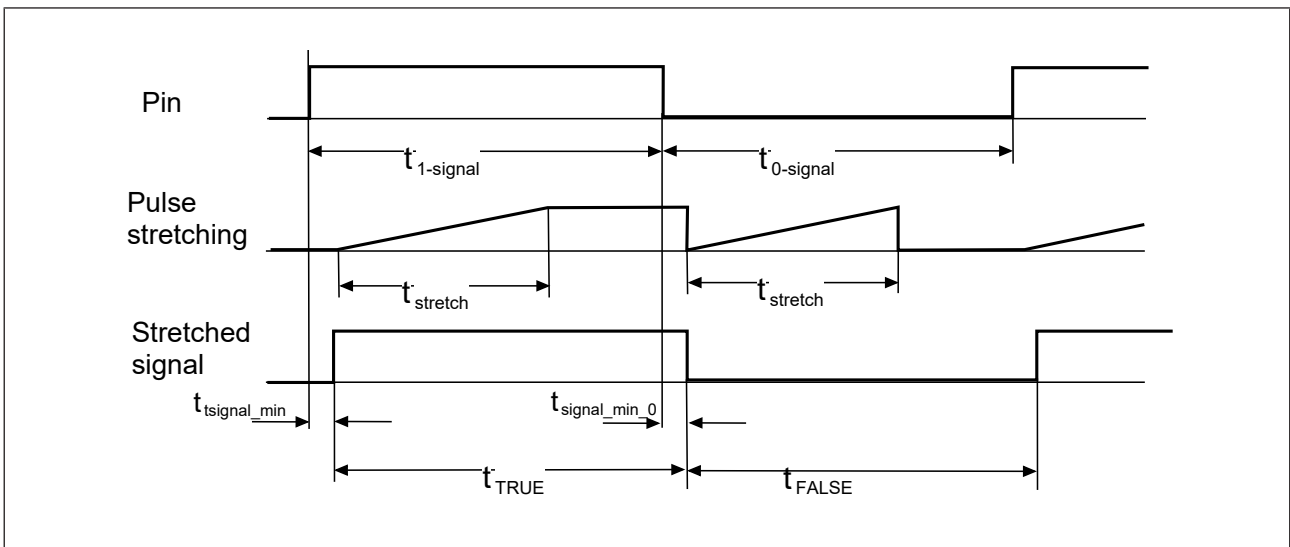

Fig.: Timing diagram: pulse stretching \leq signal duration of 1-signal

Legend

- Pin Signal at the input (pin)
- Pulse stretching Pulse stretching
- Stretched signal Stretched signal
- $t_{1\text{-signal}}$ Duration of 1-signal
- t_{stretch} Duration of pulse stretching

- $t_{\text{signal_min_0}}$ Time for which a 0-signal must be present in order to be detected safely
- $t_{\text{signal_min}}$ Time for which a 1-signal must be present in order to be detected.
- t_{TRUE} Stretched 1-signal in the device
- t_{FALSE} Stretched 0-signal in the device

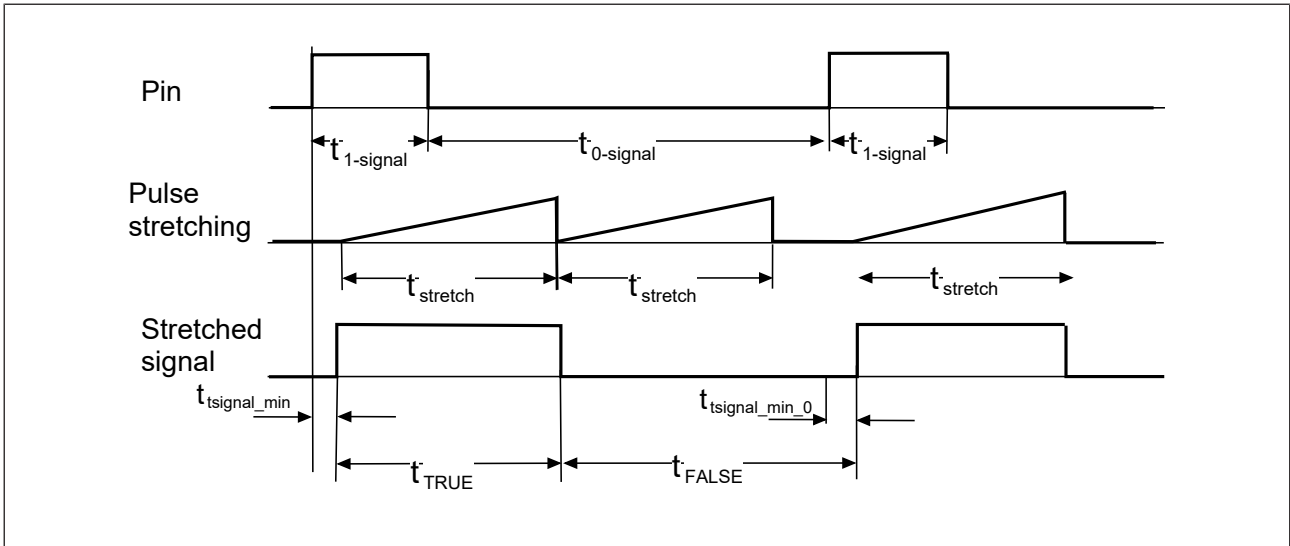

Fig.: Timing diagram: pulse stretching > signal duration of 1-signal

Legend

- Pin Signal at the input (pin)
- Pulse stretching Pulse stretching
- Stretched signal Stretched signal
- $t_{1\text{-signal}}$ Duration of 1-signal
- t_{stretch} Duration of pulse stretching
- $t_{\text{signal_min_0}}$ Time for which a 0-signal must be present in order to be detected safely
- $t_{\text{signal_min}}$ Time for which a 1-signal must be present in order to be detected.
- t_{TRUE} Stretched 1-signal in the device
- t_{FALSE} Stretched 0-signal in the device

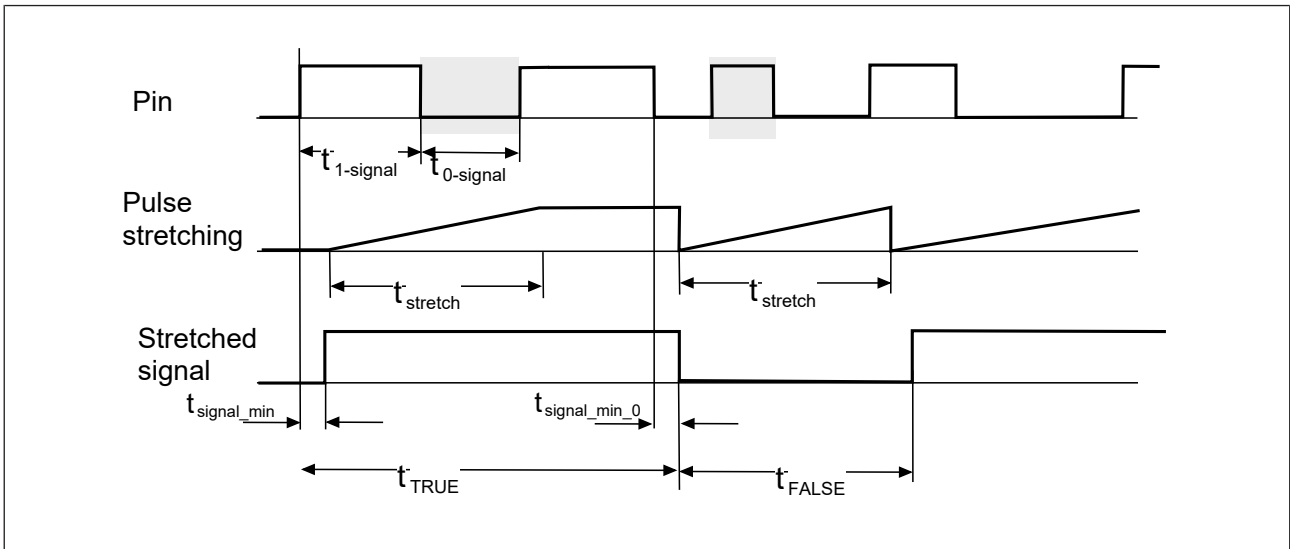

Fig.: Timing diagram: pulse stretching with variable signal duration

Legend

Pin Signal at the input (pin)

Pulse stretching Pulse stretching

Stretched signal Stretched signal

$t_{1\text{-signal}}$ Duration of 1-signal

t_{stretch} Duration of pulse stretching

$t_{\text{signal_min_0}}$ Time for which a 0-signal must be present in order to be detected safely

$t_{\text{signal_min}}$ Time for which a 1-signal must be present in order to be detected.

t_{TRUE} Stretched 1-signal in the device

t_{FALSE} Stretched 0-signal in the device

Discrepancy monitoring

With discrepancy monitoring, two individual FS inputs can be linked to a 2-channel FS input. Only inputs situated on an IO port may be used for discrepancy monitoring. Discrepancy monitoring evaluates the two input signals on a 2-channel sensor and forwards the result to the user program as a boolean safety enable signal via the process image of inputs.

An input pair always consists of the two inputs I0 and I1 on a port. 2-channel equivalent or non-equivalent sensors can be connected.

Signals with equivalent sensors:

Input	Sensor operated (safety demand)	Sensor not operated (enable)	Invalid signal 1	Invalid signal 2
I0	0	1	0	1
I1	0	1	1	0

Signals with non-equivalent sensors:

Input	Sensor operated (safety demand)	Sensor not operated (enable)	Invalid signal 1	Invalid signal 2
I0	0	1	0	1
I1	1	0	0	1

Discrepancy time

The configurable maximum duration of discrepancy monitoring ($t_{\text{conf_discr}}$) is used to determine how long a discrepant signal at the inputs will be tolerated before a discrepancy error is reported. If the configured duration has elapsed and the expected signals are not present, then a discrepancy error is reported. During this time the process image of inputs depends on the configured discrepancy behaviour.

Discrepancy behaviour

The process image during discrepancy can be configured.

- ▶ Set the value for the input pair in the PII to "0".

The value "0" is provided in the PII as soon as a discrepancy is detected. The reaction time is not determined by the time t_{discr} .

- ▶ Retain the last valid value in the PII.

The value that is evaluated is the last valid value for the lower order input of an input pair (in this example input I0) before the discrepancy arose. This value stays in the PII until the two input signals are as expected or until the time t_{discr} has elapsed and a discrepancy error has been detected. The reaction is extended by the configured time t_{discr} .

Example:

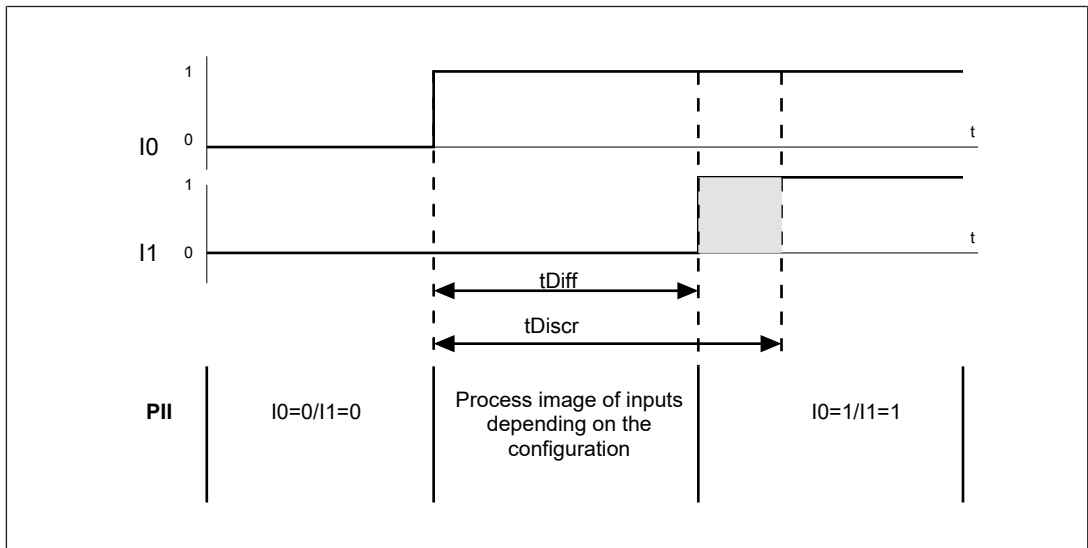

Fig.: Example for discrepancy monitoring of equivalent signals

Legend

I0 Input I0

I1 Input I1

PII Process image of inputs

t_{discr} Discrepancy time

Discrepancy monitoring is restarted as soon as both signals are as expected.

The PII during this time depends on the configuration:

- ▶ Keep last valid value: I0=0 (I1 is not evaluated)
- ▶ Set value to "0": I0=0/I1=0

t_{conf_discr} Configurable maximum duration of discrepancy monitoring

Behaviour in the event of a discrepancy error

An error message is issued for each input of a terminal pair. Both errors take into account the last valid state of both inputs before the discrepancy time elapsed.

Reintegration after a discrepancy error

After an error, discrepancy monitoring will either start automatically as soon as there is no longer a discrepancy or it will start with a restart interlock, depending on the configuration.

- ▶ **Without restart interlock** (no acknowledgement required)

As soon as there is no longer a discrepancy, monitoring begins again

► **With restart interlock** (acknowledgement required)

Equivalent sensor:

A "0" signal must be present at both inputs in a discrepancy group in order to start a new monitoring task.

Non-equivalent sensor:

Within a discrepancy group, a "0" signal must be present at input I0 and a "1" signal at input I1.

Example 1: Sensor type is configured as "non-equivalent".

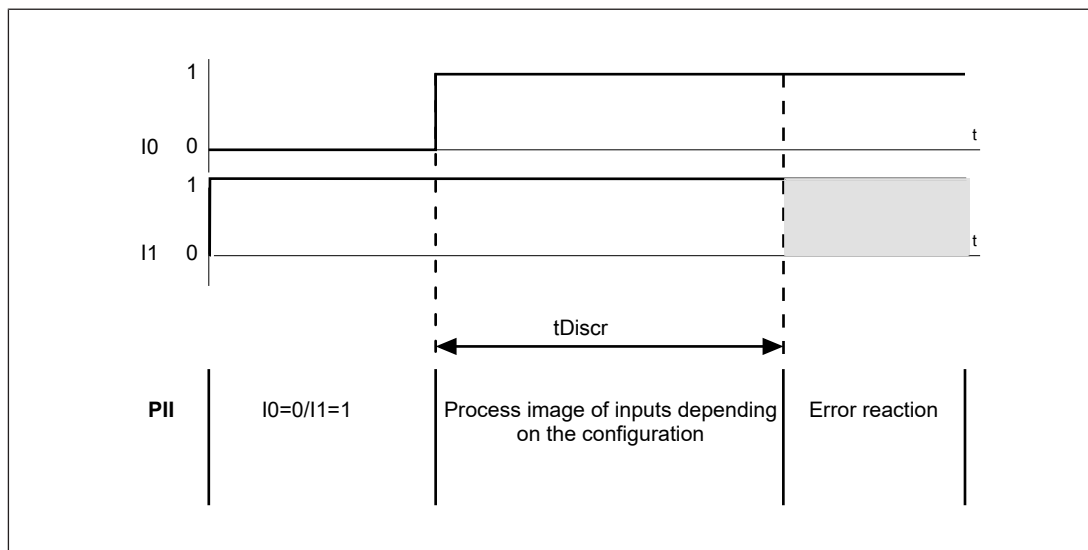

Legend

I0 Input I0

I1 Input I1

PII Process image of inputs

t_{Discr} Maximum duration of discrepancy monitoring

The PII during this time depends on the configuration:

- Keep last valid value: I0=0 (I1 is not evaluated)
- Set value to "0": I0=0/I1=0

Error messages:

Input I0: Discrepancy error. Signal at input I0 is "1"

Input I1: Discrepancy error. Signal at input I1 is "1"

Example 2: Sensor type is configured as "equivalent".

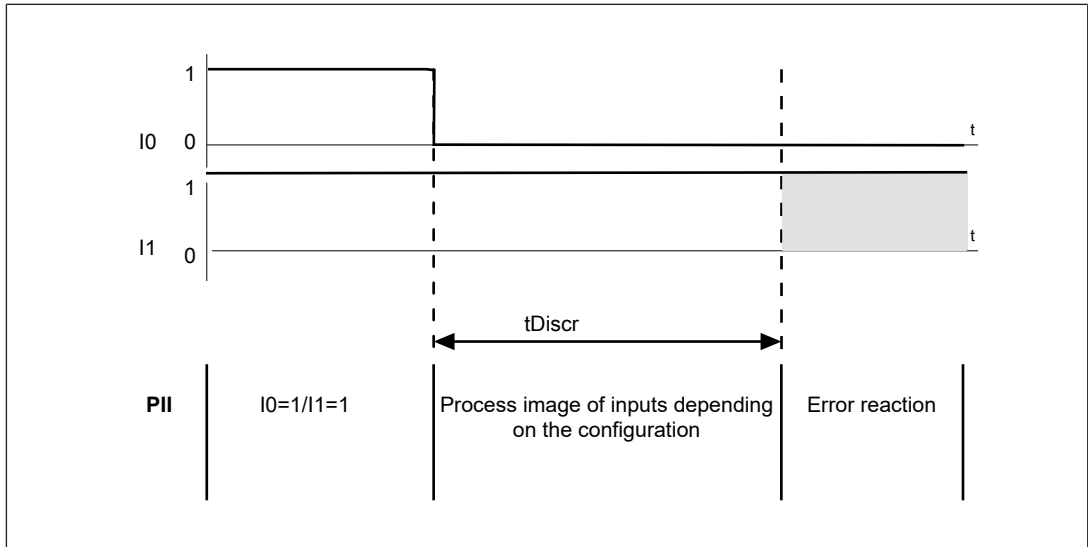

Legend

I0 Input I0

I1 Input I1

PII Process image of inputs

t_{Discr} Maximum duration of discrepancy monitoring

During this time the process image of inputs depends on the configuration:

- ▶ Keep last valid value: I0=1 (I1 is not evaluated)
- ▶ Set value to "0": I0=0/I1=0

Error messages:

Input I0: Discrepancy error. Signal at input I0 is "0"

Input I1: Discrepancy error. Signal at input I1 is "1"

Switch-on delay time

Switch-on delay time can be used to suppress the bounce from 2-channel contact-based sensors. This prevents the safety demands being triggered ("0" signal with equivalent sensors) due to bounce from contact-based sensors (e.g. when closing a safety gate).

- ▶ The switch-on delay time starts as soon as there is an enable signal ("1" signal with an equivalent sensor) at both inputs.
- ▶ If the enable signal is still present at both inputs after the switch-on delay time has elapsed and bounce monitoring time has not yet elapsed, then the enable signal is forwarded to the user program via the process image of inputs.

Bounce monitoring time

The bounce monitoring time is used to determine the maximum length of time permitted between the discrepancy analysis no longer detecting a safety demand from the sensor ("0" signal at an equivalent sensor) and the discrepancy analysis detecting a stable enable signal from the sensor ("1" signal at an equivalent sensor) (i.e. maximum permitted bounce of a 2-channel sensor).

- ▶ The bounce monitoring time starts as soon as there is an enable signal ("1" signal at an equivalent sensor) at one of the two inputs.
- ▶ The bounce monitoring time is only active and effective if a value other than 0 is set for the switch-on delay. The bounce monitoring time is configurable.

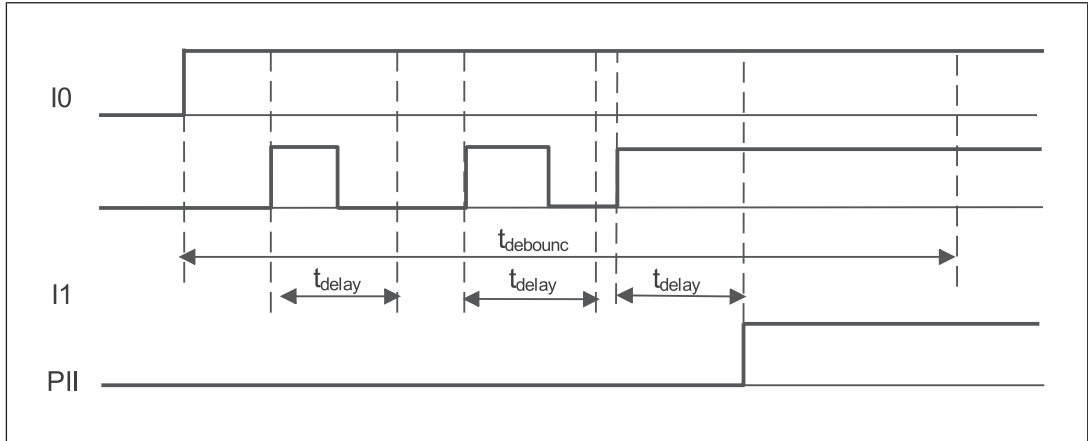

Fig.: Example of the switch-on delay time and bounce monitoring time on equivalent signals

Legend

I0	Input I0
I1	Input I1
PII	Process image of inputs
t_{debounc}	Bounce monitoring time
t_{delay}	Switch-on delay time

5.1.1.1 Test pulse outputs

The test pulses are used to detect shorts between the inputs and to detect short circuits to 24 V.

- ▶ Shorts between the cables of a 2-channel contact-based sensor are detected if:
 - Both test pulse outputs and both inputs are on the same device.
 - Both test pulse outputs are switched on, the test pulses are configured differently (T0, T1) and the emitted test pulses are assigned to the inputs.

Shorts across contacts are not detected on an electronic sensor. The sensor must detect the short circuit (2-channel OSSD).

- ▶ Short circuits to 24 V are detected on a contact-based sensor if:
 - The test pulse output and the input are on the same device.
 - The test pulse output is switched on and the test pulse output is assigned to the input.

Shorts to 24 V are not detected on an electronic sensor. The sensor must detect the short circuit (1-channel OSSD).

- ▶ The test pulses are assigned to the following inputs in the default setting:
 - T0: I0
 - T1: I1
- ▶ Inputs may only be wired to test pulses of the same IO port.

Additional configuration options for the test pulses

- ▶ **24V** option: 24 VDC is available at the test pulse outputs if they are not assigned to an input.
- ▶ **High impedance HiZ** option: The test pulse outputs can be switched off if they are not assigned to an input. The test pulse outputs are then high impedance to the device supply.
- ▶ **ST output** option: The test pulse outputs can be used as 24 VDC ST outputs if they are not assigned to an input.
- ▶ The maximum test pulse duration can be configured: 0.3 ... 10.0 ms
Default setting: 3 ms.

5.1.2 Digital outputs

Digital outputs can be used to switch actuators.

5.1.2.1 ST outputs

Unused test pulse outputs can be configured as ST outputs. If all test pulse outputs are configured as ST outputs, then 12 1-pole ST outputs are available, distributed over 6 ports.

Configuration options for the ST outputs

If the output does not receive a process image of outputs, then substitute values are used for the process data. The value that is to be used as the substitute value can be configured.

Configurable properties	Configurable values	Default value
Substitute value	<ul style="list-style-type: none"> ▶ Output switched off ▶ Output switched on ▶ Last valid value 	Output switched off

5.1.2.2 1-pole FS outputs

The device has up to 6 1-pole FS outputs distributed over 3 ports when the ports (X02, X04, X06) are configured as FS outputs.

Signals at the output

- ▶ "0" signal (0 V) at the output:
 - Output is high impedance
 - No current to the load
- ▶ "1" signal (+24 V) at the output:
 - Output is low impedance
 - Current is supplied to the load

The device can detect the following errors at the outputs:

- ▶ Shorts across contacts and short circuits
- ▶ Overload

General guidelines:

- ▶ The max. capacity at an output depends on the load (see Output capacitance C). Connecting a higher capacity may lead to an error.
- ▶ Use suppression when switching inductive loads.
- ▶ Operation with electronic contactors has not been tested and may lead to errors. Please contact our Customer Support team if you are using electronic contactors.

Configuration options for the 1-pole FS outputs:

Configurable properties	Configurable values	Default value
Pin state	<ul style="list-style-type: none"> ▶ On ▶ Off 	Off
Switch-off delay	0 ... 65535 ms	0 ms
Off test	<ul style="list-style-type: none"> ▶ Activated ▶ Deactivated 	Activated
On test	<ul style="list-style-type: none"> ▶ Activated ▶ Deactivated 	Activated
Max. test duration	0.1 ... 12.7 ms	3.0 ms
Repetition of the on test in error-free operation	▶ 0 ... 255 s	0 s
Repetition of the on test in the event of an error	▶ 0 ... 255 s	30 s
Repetition of the off test	▶ 0 ... 255 s	0 s

Pin state

A 1-pole FS output can be disabled. In this case the output can no longer be set in the process image of outputs. The LEDs for the output are switched off.

Switch-off delay

FS outputs can be switched off with a delay. Even if the process image of outputs switches from "1" to "0", a "1" signal may remain at the output for the duration of the delay. If there is another "1" signal during the switch-off delay, the switch-off delay time is reset again and restarts at the next "0" signal.

In the event of external errors, e.g. if the connection to the controller is lost, the output is switched off after the set switch-off delay.

However, in the event of internal device errors, the switch-off delay cannot be guaranteed.

Default value: 0 ms (switch off immediately).

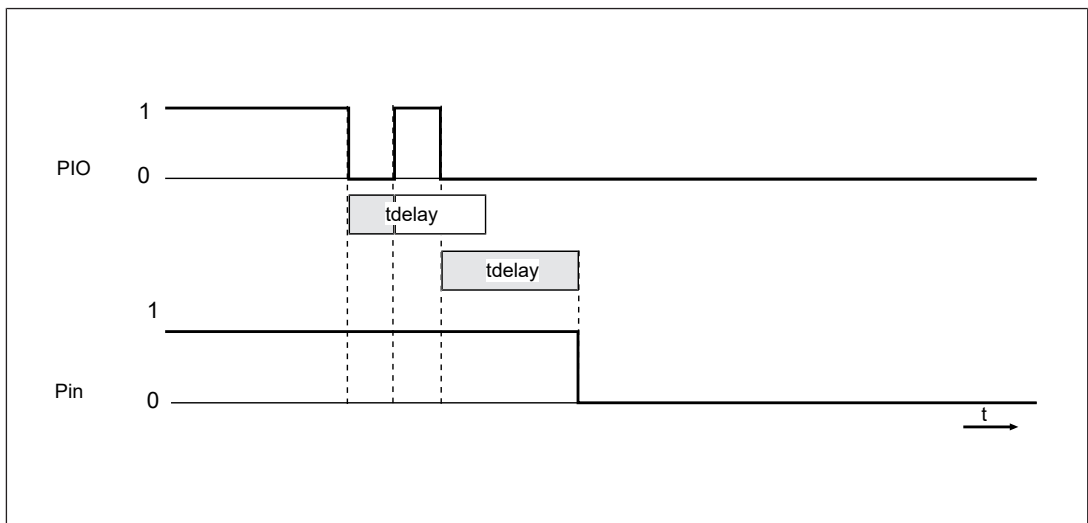

Fig.: Switch-off delay

Legend

PIO	Process image of outputs
t_{delay}	Configured switch-off delay time If there is another "1" signal, the time is reset and restarts at the next "0" signal
Pin	Signal at the pin

Output tests

Outputs that are switched on are checked via regular **off tests**.

- ▶ Off tests are run in each test cycle.
- ▶ The maximum duration of the off test can be configured (default value: 3 ms).
- ▶ Outputs that are switched on are switched off for the duration of the off test.
- ▶ The load must not switch off because of the test.
- ▶ An off test detects the following errors:
 - Shorts between the outputs.
 - Short circuit to the actuator supply voltage, if the actuator supply voltage is not galvanically isolated.

Outputs that are switched off are checked via regular **on tests**.

- ▶ Outputs that are switched off are switched on for the duration of the on test.
- ▶ The load must not switch on because of the test.
- ▶ An on test is considered successful when the switching on of the output has been fed back within the configured maximum duration of the on test.
- ▶ The maximum duration of the on test can be configured (default value: 3 ms).
- ▶ On tests are run based on the configured repetition time. If a repetition time has not been configured, then on tests are run in each test cycle. If a repetition time has been configured, then the on test will not be run for the configured time.
- ▶ If an output can no longer be switched on due to an error, then the error will be detected within the repetition of the on test in the event of an error, as set in the configuration.

- ▶ An on test detects the following errors:
 - Shorts between the outputs.
 - Short circuit to the actuator supply voltage, if the actuator supply voltage is not galvanically isolated.

Exclude individual outputs from the output test

If a plant is particularly sensitive to the output test, the output test may be switched off for individual outputs. The test must be replaced by other measures, depending on the safety requirement.

When output tests are switched off:

- ▶ The correct switch state is always checked.
- ▶ The output's ability to switch will not be detected until the next time the output is switched on/off. That is why the outputs must be switched regularly during normal operation, so that safety and characteristic safety values are not reduced.
- ▶ For applications in accordance with Category 4, PL e and SIL 3, detection of shorts between contacts must be guaranteed either via the on/off test or through other measures (e.g. asynchronous switching). A short between contacts must be simulated during commissioning.



WARNING!

When wiring an output with capacitance it is essential to note the test duration and repetition period of the on test, otherwise the load may switch on unintentionally.

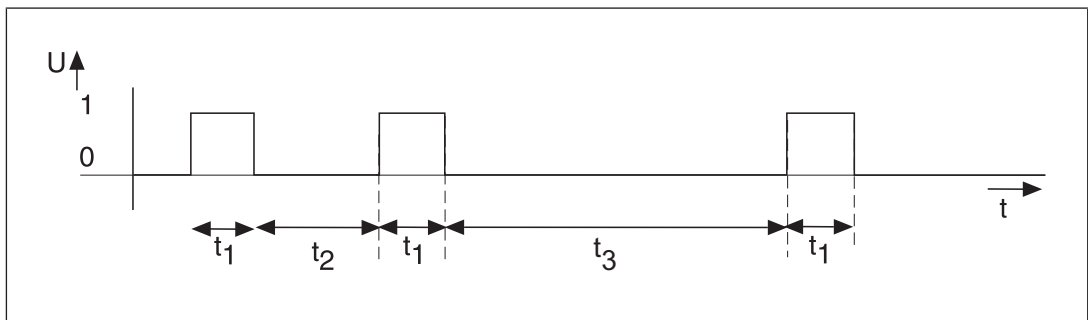

Fig.: On test for 1-pole outputs

Legend

- t_1 Configurable max. test duration (default value: 3 ms)
- t_2 Configurable repetition time of the on test in error-free operation. Defines the waiting time between two on tests. (Default value: 0 s. The test is run in each test cycle).
- t_3 Configurable repetition time of the on test in the event of an error (default value: 30 s)

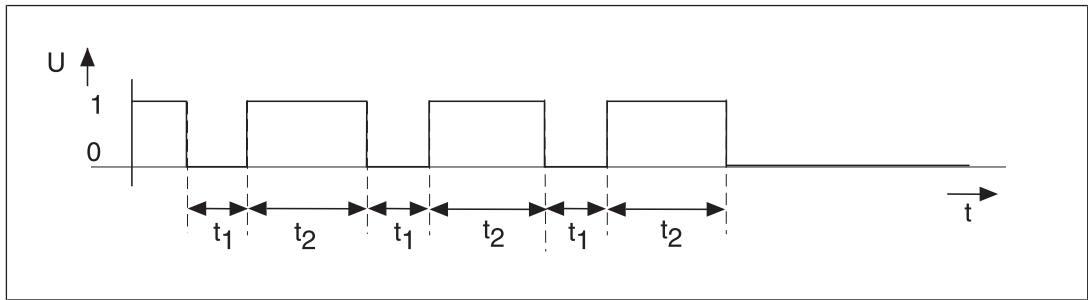

Fig.: Off test for 1-pole outputs

Legend

t_1 Configurable max. test duration (default value: 3 ms)

t_2 Configurable repetition time of the off test in error-free operation. Defines the waiting time between two off tests. (Default value: 0 s. The test is run in each test cycle).

Maximum test duration

Defines the maximum duration t_1 of the on and off test. If the output has failed to switch on or off after the configured time, then the current output test has been unsuccessful. The output may be read back incorrectly for the configured time. An error is registered once the configured time has elapsed.

Output capacitance C

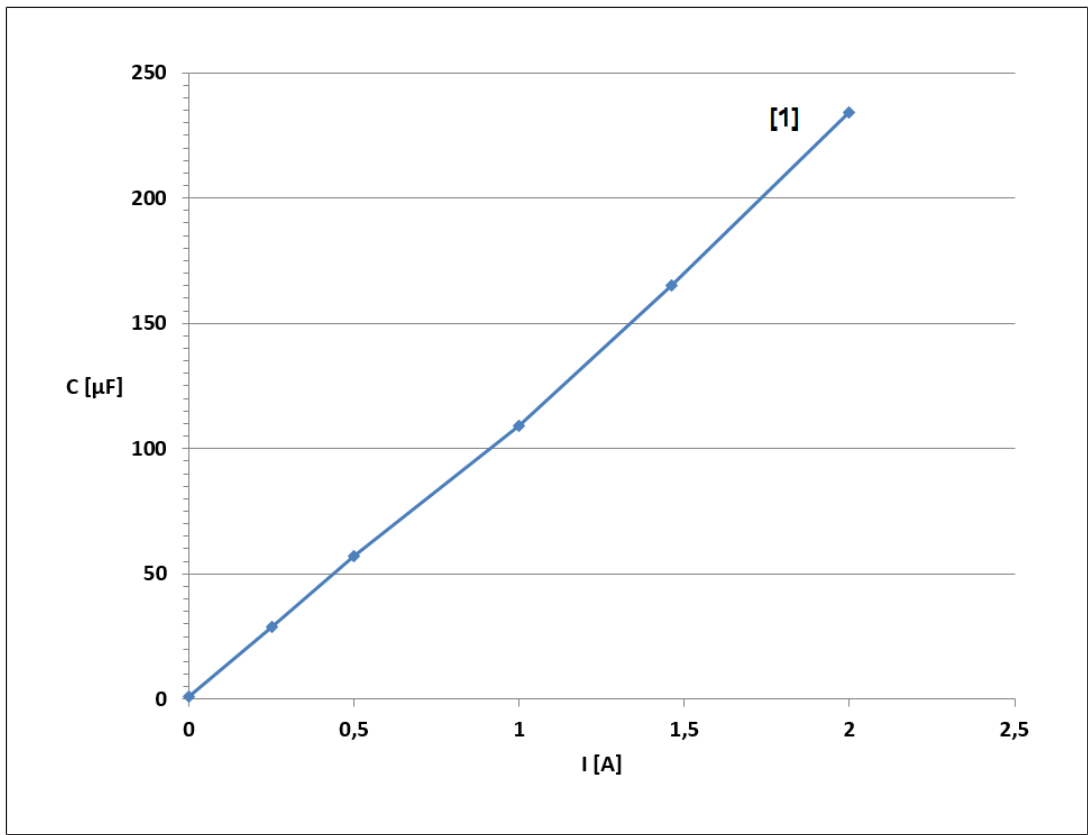

Fig.: Output capacitance C dependent on load current I

Legend

[1] Max. test duration 3 ms

5.1.2.3

2-pole FS outputs

The device has two 2-pole digital FS outputs distributed over 2 ports (X07, X08).

Signals at the output

- ▶ “0” signal (0 V) at the output (O0+/O0-):
 - Output is high impedance
 - No current to the load
- ▶ “1” signal (+24 V) at the output (O0+/O0-):
 - Output is low impedance
 - Current is supplied to the load

The device can detect the following errors at the outputs:

- ▶ Shorts across contacts and short circuits
- ▶ Overload
- ▶ Open circuit

General guidelines:

- ▶ The max. capacity at an output depends on the load (see Output capacitance C). Connecting a higher capacity may lead to an error.
- ▶ Operation with electronic contactors has not been tested and may lead to errors. Please contact our Customer Support team if you are using electronic contactors.
- ▶ The outputs do not need suppression for inductive loads.
- ▶ Cannot be used as a 1-pole output

Configuration options for the 2-pole FS outputs

Configurable properties	Configurable values	Default value
Pin state	<ul style="list-style-type: none"> ▶ On ▶ Off 	On
Switch-off delay	0 ... 65535 ms	0 ms
Max. test duration	0.1 ... 12.7 ms	3.0 ms
Open circuit detection	<ul style="list-style-type: none"> ▶ Switch off output and send error message ▶ Send error message only ▶ Ignore open circuit detection 	Switch off output and send error message

Pin state

A 2-pole FS output can be deactivated. In this case the output can no longer be set in the process image of outputs. The LEDs for the output are switched off.

Switch-off delay

FS outputs can be switched off with a delay. Even if the process image of outputs switches from "1" to "0", a "1" signal may remain at the output for the duration of the delay. If there is another "1" signal during the switch-off delay, the switch-off delay time is reset again and restarts at the next "0" signal.

In the event of external errors, e.g. if the connection to the controller is lost, the output is switched off after the set switch-off delay.

However, in the event of internal device errors, the switch-off delay cannot be guaranteed.

Default value: 0 ms (switch off immediately).

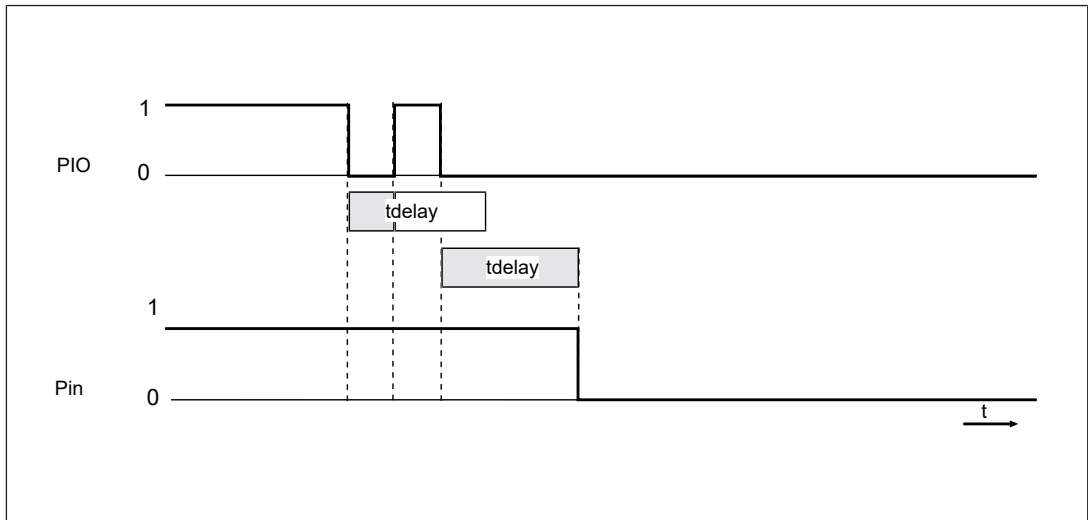

Fig.: Switch-off delay

Legend

PIO	Process image of outputs
t_{delay}	Configured switch-off delay time If there is another "1" signal, the time is reset and restarts at the next "0" signal
Pin	Signal at the pin

Output tests (cannot be deactivated)

► Asymmetric test in error-free operation

- In this test, one output transistor is switched on and the other switched off for the test duration t_1 as a maximum. The load is not switched on because of the test. If errors are detected during this test, than an advanced on test is run.
- The maximum test duration t_1 can be configured.
- The repetition time of the asymmetric test t_2 is determined by the device.

► Advanced on test in the event of an error

- The test is run for the test duration t_1 as a maximum.
- The maximum test duration t_1 can be configured.
- The test enables precise error diagnostics.
- The first test ([1] in the diagram) in the advanced on test is always run directly after an asymmetric test, in which an error has occurred. It is used to determine the cause of the error.
- Further tests ([2] to [n] in the diagram) are run after a repetition time t_3 . The repetition time t_3 can be configured at device level for all 2-pole outputs. It is not possible to configure the time for each IO port separately. These tests are used to check whether an error is still present.

- The load must not switch on because of the test.
- The following errors are detected:
 - Shorts across contacts (external error),
 - Short circuits and interruptions on the transistors,
 - Short circuits and open circuit on the connected load

Function diagrams for the output test

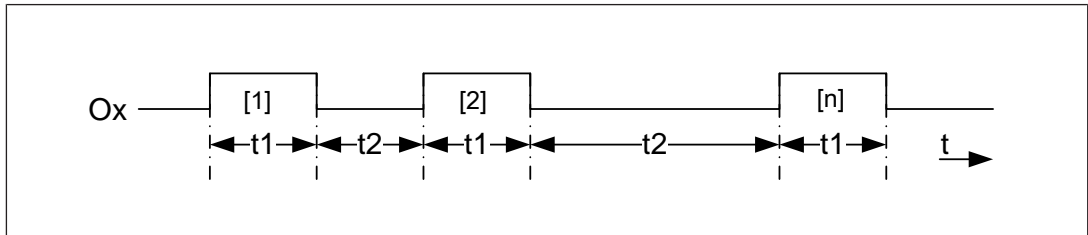

Fig.: Asymmetric test (only run in error-free operation). The switching capability of O+ and O- is checked in separate tests.

Legend

- t_1 Configurable maximum test duration (default value: 3 ms)
- t_2 Repetition time between asymmetric tests in error-free operation. The time is not configurable and is determined by the device.

[1] [2] [n] Asymmetry tests

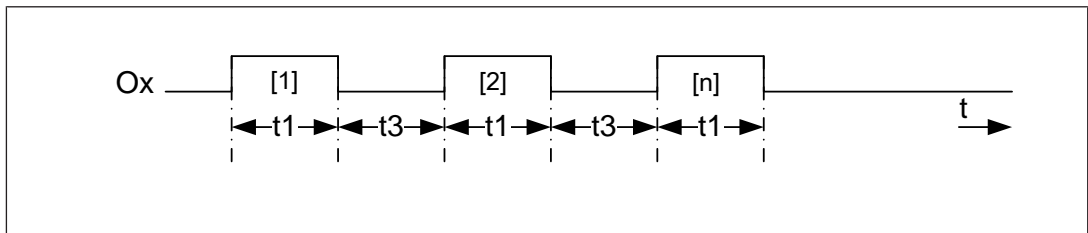

Fig.: Advanced on test (only run in the event of an error)

Legend

- t_1 Configurable maximum test duration (default value: 3 ms)
- t_3 Repetition time of the advanced on test in the event of an error (default value: 30 s)

[1] [2] [n] Advanced on tests



INFORMATION

For the maximum test duration t_1 , set a maximum value at which the load can neither switch on nor switch off. By setting a maximum permitted test duration t_1 for your application you increase availability and improve fault detection.



WARNING!

The advanced on tests can cause a capacitive load to switch on unintentionally.

It is essential to note the test duration t_1 and the repetition time of the advanced on test in case of an error.

Open circuit detection

- ▶ The device will detect an open circuit between outputs Ox+ and Ox-.
- ▶ The behaviour after an open circuit is detected is configurable:
 - Switch off output and send error message.
The outputs are switched off and an error message is sent. The open circuit is registered in the PII and the open circuit bits are set to "0".
 - Send error message only
The outputs are not shut down. The open circuit is registered in the PII.
 - Ignore open circuit detection
The outputs are **not** switched off and **no** error message is sent.
The open circuit is **not** registered in the PII and the open circuit bits remain at "1".
- ▶ Loads over 10 kOhm may mistakenly be detected as an open circuit.

Output capacitance C

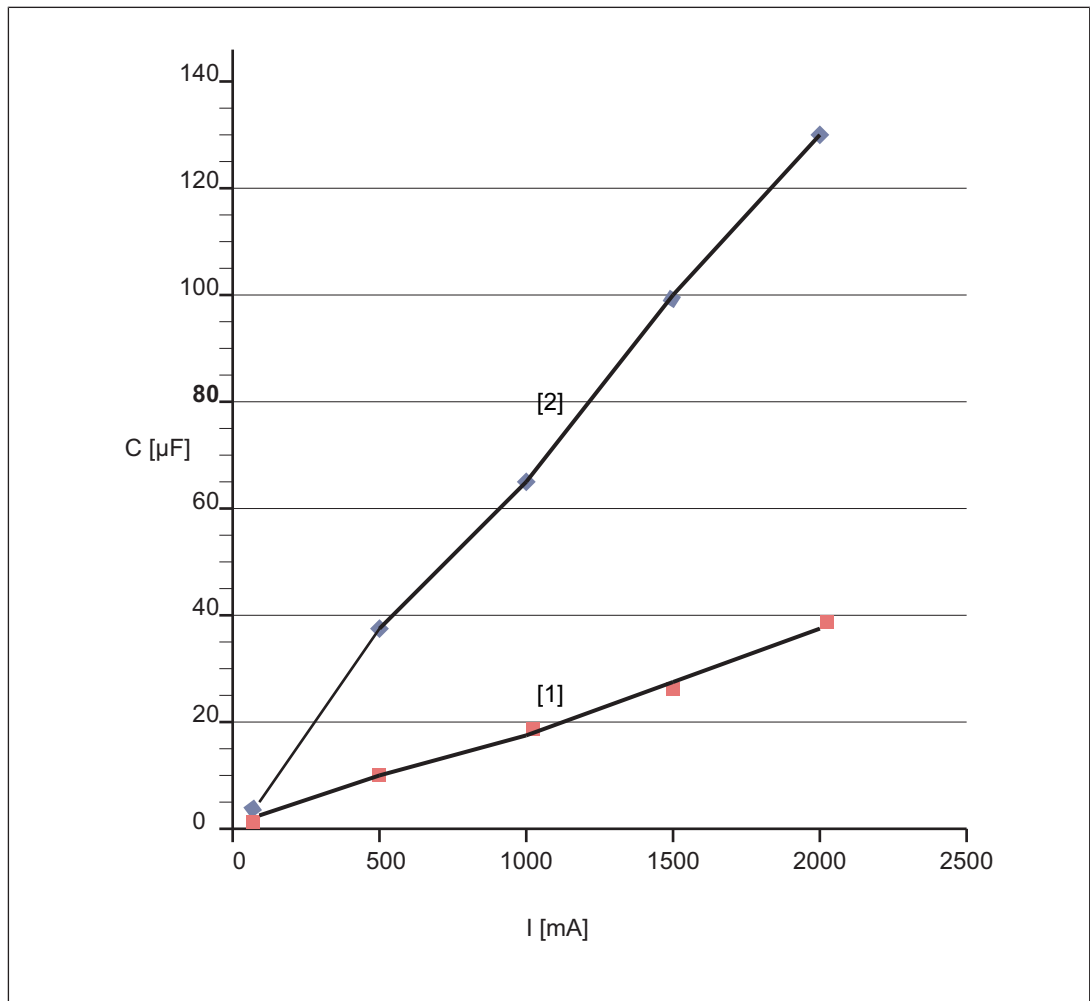

Fig.: Output capacitance C dependent on load current I

Legend

- [1] Max. test duration 1 ms
- [2] Max. test duration 3 ms

5.2 Device area

5.2.1 Integrated protection mechanisms

The device has the following protection mechanisms:

- ▶ Multi-channel diverse processors
- ▶ Cyclical self tests
- ▶ Potentially isolated **PROFINET** interface
- ▶ Potentially isolated processor area
- ▶ Common second shutdown route, tested regularly
- ▶ Cyclical output tests
- ▶ Tests for shorts between the outputs
- ▶ Test pulse signals are always buffered for 20 ms.
- ▶ Supply voltage:
 - Polarity protection
 - Voltage monitoring
 - Potential isolation

5.2.2 Reset button

The reset button is sealed with an end cap. To achieve protection class IP67, the end cap must be fastened with a torque setting of 0.6 Nm. We recommend you use a torque screwdriver with PH3 bit.

Carrying out a warm reset (restart)

A warm reset is used to restart the device.

Procedure:

- ▶ Press the reset button for less than 5 seconds.

Performing a cold start/reboot command initiates the following procedure:

- ▶ Processing is aborted
 - All LEDs are switched off.
- ▶ System is initialised
 - Device is ready for operation and the "MS" LED flashes green.
- ▶ System switches to "Operational" state
 - Device is in operation and the "MS" LED lights up green.
- ▶ Entry is made in the diagnostic log

Impact after a restart:

- ▶ Inputs retain their current input values
- ▶ Substitute values are used for the outputs until the connection to the controller has been re-established.

Transfer device project from the PDP67 removable data medium to the device

Prerequisites

- ▶ A PDP67 removable data medium with a microSD card must be installed on the device.
- ▶ The microSD card may not be empty or defective.
- ▶ The device project on the microSD card must match the product type.

Procedure:

- ▶ Press the reset button for more than 5 seconds. The SD LED flashes yellow.
- ▶ Release the reset button, then press and release it again within 10 seconds.
- ▶ The device project is transferred from the microSD card to the device.
- ▶ Once the device project has been transferred the device has the IP address 0.0.0.0.

If the required files are not on the microSD card, the device exchange scenario is not performed and an entry is written in the diagnostic log.

If no microSD card is inserted, an original reset is performed.

Performing an original reset

Procedure:

- ▶ Press the reset button for more than 5 seconds. The SD LED flashes yellow.
- ▶ Release the reset button, then press and release it again within 10 seconds. If the reset button is not pressed and released within 10 seconds, then the reset request is rejected.
- ▶ The device performs an original reset.

If the microSD card contains a valid configuration then this will be transferred through the original reset (see Transfer device project).

Effects of the original reset:

- ▶ ST and FS configuration data is deleted.
- ▶ PROFINET Factory Reset is performed.
- ▶ Diagnostic log is not deleted.
- ▶ Device restarts automatically.

5.2.3

PDP67 removable data medium (available as an option)



Fig.: PDP67 removable data medium

The PDP67 removable data medium is available as an accessory (order number: 4R000002). It can be used to store the configuration data on the supplied microSD card.

- ▶ Scope of supply:
 - PDP67 removable data medium
 - microSD card with 512 MB

Installing the PDP67 removable data medium

Ensure that the microSD card is inserted correctly before tightening the end cap. If the end cap is tightened when the microSD card is positioned incorrectly, the microSD card or PDP67 removable data medium may be destroyed.

- ▶ Switch off the power to the device to avoid losing data.
- ▶ Hand-tighten the end cap to ensure protection type IP65/67. The end cap should not be opened and closed more than 10 times so as not to lose protection type IP65/67.
- ▶ Using a torque wrench (width across flats 13 mm), tighten the PDP67 removable data medium to 0.6Nm at port X20 to ensure protection type IP65/67 (torque wrench: Conec 36-000200 for example).

The PDP67 removable data medium can be installed and removed at least 100 times without losing contact security and protection type IP65/67.

Removing the PDP67 removable data medium

- ▶ Switch off the power to the device to avoid losing data.
- ▶ Unscrew the PDP67 removable data medium using a wrench with 13 mm width across flats.

Using the microSD card

- ▶ Turn the microSD card so that the contacts on the microSD card are facing upwards when you insert it into the PDP67 removable data medium.
- ▶ Slide the microSD card into the slot on the PDP67 removable data medium until you hear it lock into position.

If you use the optional removable data medium, then data that is relevant for the device exchange will be stored on the data medium.



NOTICE

The microSD card includes safety data. Ensure that the microSD card is plugged in before commissioning. After commissioning, use PASconfig to check the FS check sum of the system on the microSD card. It has to match to the FS check sum of the configured system. To ensure that final data are stored on the data medium, do not remove the microSD card before completing the checking.

When a device is changed, the stored data can be copied over using the reset button (see [Reset button](#) [ 40]).

Removing the microSD card

- ▶ Unscrew the end cap. If you are using several devices with end caps, make sure that you don't mix up the labelled end caps.
- ▶ Press lightly on the microSD card until it releases and then use your fingers to pull the microSD card out of the PDP67 removable data medium.

Labelling the PDP67 removable data medium

You can label the PDP67 removable data medium on the labelling strip provided.

5.3 Supply voltages

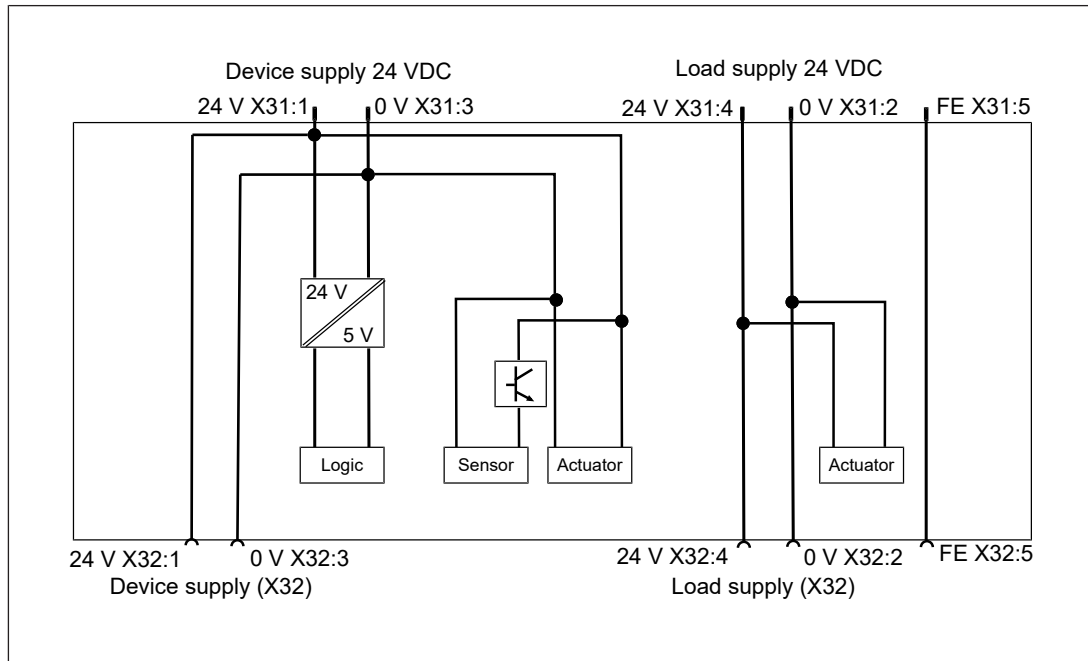

Fig.: Supply voltage

Device supply and load supply

The supply voltages are fed in at port X31 (for assignment see [Connecting the supply voltage](#) [79]). Port X32 is used to forward the supply voltage to other devices.

► Device supply

The voltage to supply the device, sensors and actuators is generated internally from the device supply.

The sensor supply potential of each individual IO port is buffered separately and independently from the other IO ports in such a way that power failures of up to 20 ms can be bridged. The buffering is designed for the input currents.

► Load supply

The voltage to supply the actuators is generated internally from the load supply.

- The potentials for the device supply and load supply are galvanically isolated within the device.

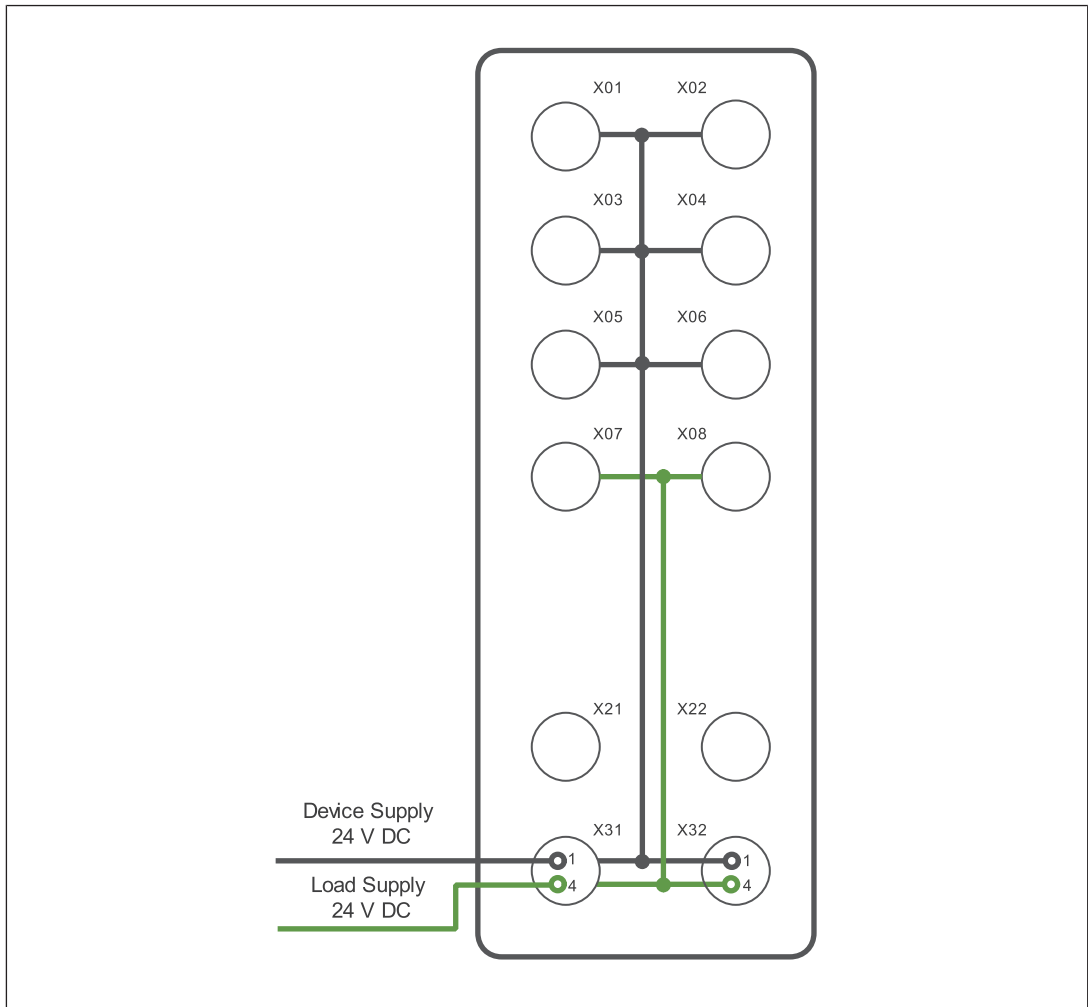

Fig.: Supply voltage per plug-in connector

5.4 PROFINET with PROFIsafe

The device has a PROFINET interface with PROFIsafe profile with the following properties:

- ▶ PROFINET Conformance Class C
- ▶ IRT/RT
- ▶ Data set I&M 0-4

Default values:

- ▶ IP Address: 0.0.0.0
- ▶ Subnet mask: 0.0.0.0
- ▶ Gateway address: 0.0.0.0
- ▶ Device name: "" (blank)

5.4.1 MAC addresses

The device MAC address is lasered on to the front of the device. For "neighbourhood discovery" via the Link Layer Discovery Protocol (LLDP), PROFINET does not need the device MAC address but the MAC address of the physical Ethernet port, through which the device is connected to PROFINET. The device has an integrated switch with 2 physical Ethernet ports. Both ports use the two MAC addresses that follow the device MAC address; i.e. a device has 3 consecutive MAC addresses.

- ▶ MAC address for port X21 corresponds to the device MAC address printed on the device + 1
- ▶ MAC address for port X22 corresponds to the device MAC address printed on the device + 2

5.4.2 Setting the IP address

On delivery the device has no IP address (default value 0.0.0.0). The IP address is needed for communication within the Ethernet network. You can set the IP address in the engineering tool for the PROFIsafe Master (e.g. TIA).

5.4.3 Setting the F-address

The F-address can be set using PASconfig (see online help for PASconfig). The F-address in the TIA portal must match the F-address configured in PASconfig, otherwise error-free operation is impossible. The default address for the PDP67 device is 1.



INFORMATION

Each F-address on PROFINET with PROFIsafe must be unique.

Further information on the F-address: [Establishing the F-address \(PROFINET with PROFIsafe\)](#) [ 106]

5.4.4 Deactivation and reactivation

Passivation/reactivation can be module-granular or channel-granular.

▶ **Module-granular passivation:**

In the event of an error on an FS input or FS output:

- All FS inputs and outputs are disabled
- The VALID bit of the FS inputs and outputs is set to "0"
- The process image of inputs and outputs are set to the safe value (= zero). Substitute values are emitted (see [Substitute values](#)  47]).

▶ **Channel-granular passivation:**

In the event of an error on an FS input or FS output:

- The affected FS input or output is disabled
- The VALID bit of the affected FS input or output is set to "0"
- The process image of the affected FS input or output is set to the safe value (= zero). Substitute values are emitted (see [Substitute values](#)  47]).

Passivation is configured by positioning the relevant PROFIsafe container on slot 11 of the PROFINET configuration in the engineering tool for the PROFIsafe Master (e.g. TIA) and by configuring passivation in PASconfig.

Reintegration after an error

If the error is no longer present, the passivated channels can be reintegrated. This is called reactivation. Automatic or manual reintegration can be configured for reactivation in the engineering tool for the PROFIsafe Master (e.g. TIA). Automatic reintegration may only be configured if it is permitted for the respective process in terms of safety.

▶ **Behaviour after reactivation**

- The VALID bit becomes "1", provided there is no PROFIsafe malfunction.

5.4.5 Substitute values

If the valid bit has the value "0", then the process image is invalid and may not be used. If this is the case, the process image has a substitute value which is used instead of the device's process value. Substitute values can be configured for ST outputs. For all other FS inputs and outputs, the substitute value is the safe state ("0").

Situations that mean that substitute values are used and the valid bit has the value "0":

- ▶ Input error
- ▶ Output error
- ▶ Device error (e.g. drop in the supply voltage, device overheats)
- ▶ Communication is stopped (also during firmware update)

5.4.6 Projects

To configure the device you will need the STEP 7 software or TIA Portal from Siemens and PASconfig. PASconfig can be called directly from STEP 7 or TIA Portal. The system data can be transferred to the device with PASconfig via the PROFINET interfaces X21 or X22.

Please note the following:

- ▶ The user must test the application in order to avoid programming and configuration errors, as well as errors when transferring data to the devices. Safety-related functions and their configuration must be successfully tested in full before the application is commissioned (e.g. test pulses, on/off tests).
- ▶ After each configuration change, the user must ensure that the check sums for the configuration in the PASconfig, the device and the removable data medium (if present) are identical.
- ▶ The application must be designed in such a way that an uncontrolled start-up of the plant is excluded after a safety function, restart or reset is requested.
- ▶ After each firmware update it is necessary to check that the new firmware is the desired firmware version.

5.4.7 Process image

Device model

Each IO port is modelled as a virtual PROFINET module and has a PROFINET diagnostic address. The virtual modules occupy the following PROFINET slots in the device description file:

PROFINET slot	PROFINET module	IO port	Special features
0	DAP		
1	2FDI	X01	Virtual PROFINET module without process data. The module is used for diagnostics only and is configured in PASconfig
2	2FDIO	X02	Virtual PROFINET module without process data. The module is used for diagnostics only and is configured in PASconfig
3	2FDI	X03	Virtual PROFINET module without process data. The module is used for diagnostics only and is configured in PASconfig
4	2FDIO	X04	Virtual PROFINET module without process data. The module is used for diagnostics only and is configured in PASconfig
5	2FDI	X05	Virtual PROFINET module without process data. The module is used for diagnostics only and is configured in PASconfig
6	2FDIO	X06	Virtual PROFINET module without process data. The module is used for diagnostics only and is configured in PASconfig
7	FDOTP	X07	Virtual PROFINET module without process data. The module is used for diagnostics only and is configured in PASconfig
8	FDOTP	X08	Virtual PROFINET module without process data. The module is used for diagnostics only and is configured in PASconfig
9	Not used		
10	12DO		ST container
11	PROFIsafe container		FS container for module or channel-granular passivation

The FS process data is transferred in one of the two PROFIsafe containers on slot 11. The following PROFIsafe containers can be configured:

- ▶ Container for PROFIsafe process data with module-granular passivation (in accordance with PROFIsafe specification Version 2.4)
- ▶ Container for PROFIsafe process data with channel-granular passivation (in accordance with PROFIsafe specification Version 2.6)

The ST process data is transferred in an ST container on slot 10.

Structure of the process image:

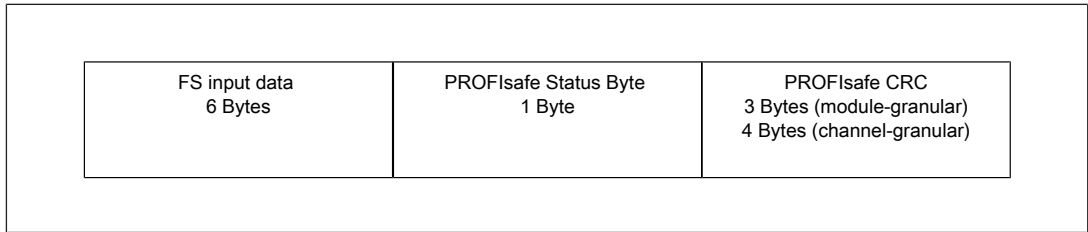

Fig.: Process image of inputs

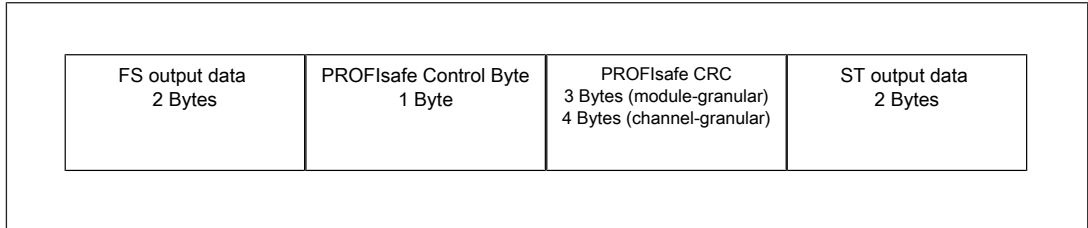

Fig.: Process image of outputs

FS input data in the process image of inputs (6 Bytes)

Byte	Bit 7	Bit 6	Bit 5	Bit 4	Bit 3	Bit 2	Bit 1	Bit 0
0	FALSE "0"	FALSE "0"	P5.I1(X5:2)	P5.I0(X5:4)	P3.I1(X3:2)	P3.I0(X3:4)	P1.I1(X1:2)	P1.I0(X1:4)
1	FALSE "0"	FALSE "0"	P6.I1(X6:2)	P6.I0(X6:4)	P4.I1(X4:2)	P4.I0(X4:4)	P2.I1(X2:2)	P2.I0(X2:4)
2	FALSE "0"	FALSE "0"	Valid bit from P5.I1	Valid bit from P5.I0	Valid bit from P3.I1	Valid bit from P3.I1	Valid bit from P1.I1	Valid bit from P1.I0
3	FALSE "0"	FALSE "0"	Valid bit from P6.I1	Valid bit from P6.I0	Valid bit from P4.I1	Valid bit from P4.I0	Valid bit from P2.I1	Valid bit from P2.I0
4	FALSE "0"	FALSE "0"	FALSE "0"	FALSE "0"	Open cir- cuit at P8.O0	Open cir- cuit at P7.O0	Valid bit from P8.O0	Valid bit from P7.O0
5	FALSE "0"	FALSE "0"	Valid bit from P6.O1	Valid bit from P6.O0	Valid bit from P4.O1	Valid bit from P4.O0	Valid bit from P2.O1	Valid bit from P2.O0

FS output data in the process image of outputs (2 Bytes)

Byte	Bit 7	Bit 6	Bit 5	Bit 4	Bit 3	Bit 2	Bit 1	Bit 0
0	FALSE "0"	FALSE "0"	FALSE "0"	FALSE "0"	FALSE "0"	FALSE "0"	P8.O0 (X8:3+4)	P7.O0 (X7:3+4)
1	FALSE "0"	FALSE "0"	P6.O1 (X6:2)	P6.O0 (X6:4)	P4.O1 (X4:2)	P4.O0 (X4:4)	P2.O1 (X2:2)	P2.O0 (X2:4)

ST output data in the process image of outputs (2 Bytes)

Byte	Bit 7	Bit 6	Bit 5	Bit 4	Bit 3	Bit 2	Bit 1	Bit 0
0	FALSE "0"	FALSE "0"	P5.O1 (X5:5)	P5.O0 (X5:1)	P3.O1 (X3:5)	P3.O0 (X3:1)	P1.O1 (X1:5)	P1.O0 (X1:1)
1	FALSE "0"	FALSE "0"	P6.O1 (X6:5)	P6.O0 (X6:1)	P4.O1 (X4:5)	P4.O0 (X4:1)	P2.O1 (X2:5)	P2.O0 (X2:1)

5.4.8 Device identification

If a device identification is requested via the engineering tool for the PROFIsafe Master (e.g. TIA), the

▶ **DIAG** und **RUN** LEDs light up green for several seconds on the selected device.

Thereafter the LEDs switch back to their original states (see [Display elements \[87\]](#)).

5.5 Derating diagram

The relationship between the load current at the device supply and the operating temperature is illustrated in the following derating diagram. The device supply is limited to a maximum of 16 A.

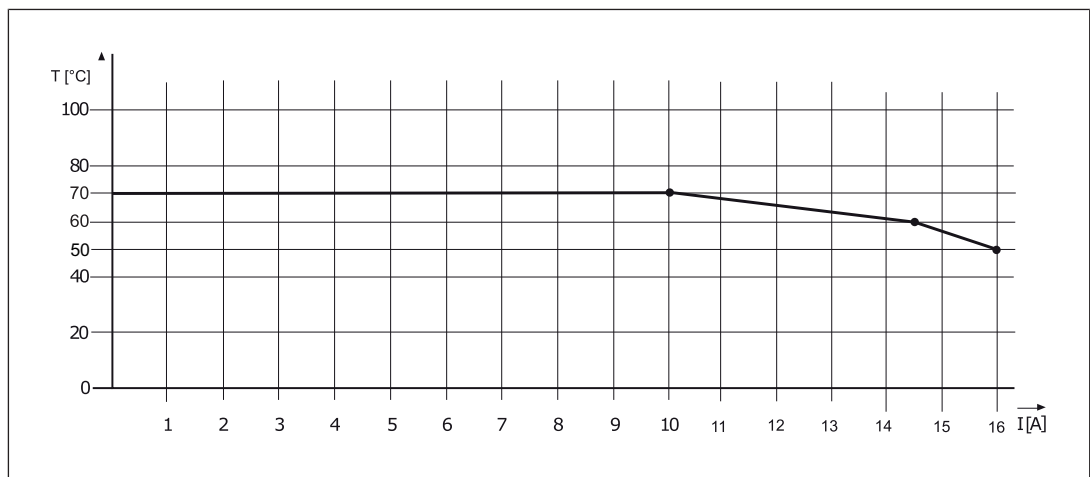

Fig.: Derating diagram for the device supply

The relationship between the load current at the load supply and the operating temperature is illustrated in the following derating diagram. The load supply is limited to a maximum of 16 A.

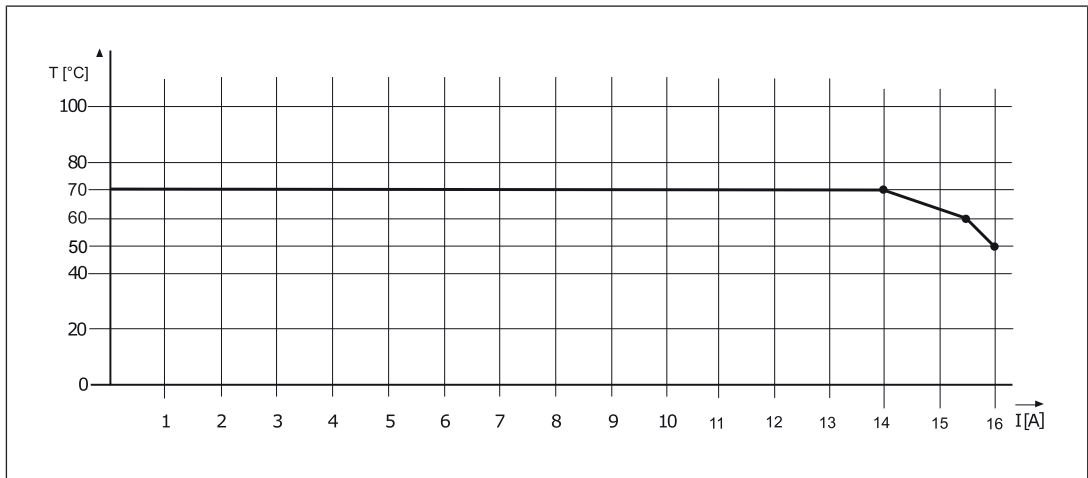

Fig.: Derating diagram for the load supply

5.6 Reaction times

Calculation of the processing times for dual-channel signals.

Worst Case Delay Time (WCDDT) input

Calculation of the time between a signal changing at the input and the signal being available at the fieldbus interface:

$$\text{WCDDT}_{\text{Input}} = 6 \text{ ms} + t_{\text{TestPulse}} + t_{\text{SW-Filter}} + t_{\text{Discr}} + t_{\text{Delay}} + t_{\text{Bounce}}$$

$t_{\text{TestPulse}}$: Configured test pulse duration

$t_{\text{SW-Filter}}$: Configured software filter time (see "Software filter time" in the [Technical details \[93\]](#))

t_{Discr} : Configured discrepancy time

t_{Delay} : Configured switch-on delay

t_{Bounce} : Configured bounce time

► When test pulses are deactivated

$$t_{\text{TestPulse}} = 0$$

► When discrepancy monitoring is deactivated

$$t_{\text{Discr}} = t_{\text{Delay}} = t_{\text{Bounce}} = 0$$

► When discrepancy monitoring is activated and discrepancy behaviour is "Set value to zero"

Signal changes from "1" to "0":

$$t_{\text{Discr}} = t_{\text{Delay}} = t_{\text{Bounce}} = t_{\text{TestPulse}} = 0$$

Signal changes from "0" to "1":

t_{Discr} : Configured discrepancy time

t_{Delay} : Configured switch-on delay

t_{Bounce} : Configured bounce time

► When discrepancy monitoring is activated and discrepancy behaviour is "Keep last valid value"

Signal changes from "1" to "0"

$$t_{\text{Delay}} = t_{\text{Bounce}} = 0$$

t_{Discr} : Configured discrepancy time

Signal changes from "0" to "1":

t_{Discr} : Configured discrepancy time

t_{Delay} : Configured switch-on delay

t_{Bounce} : Configured bounce time

One Fault Delay Time (OFDT) input

Calculation of the time between a signal changing at the input and the signal being available at the fieldbus interface when a fault occurs:

$$\text{OFDT}_{\text{Input}} = \text{WCDT}_{\text{Input}}$$

Worst Case Delay Time (WCDT) output

Calculation of the time between the signal being received at the fieldbus interface and the output switching:

$$\text{WCDT}_{\text{Output}} = 6 \text{ ms} + t_{\text{Out_Delay}}$$

$t_{\text{Out_Delay}}$: Output's configured switch-off delay

One Fault Delay Time (OFDT) output

Calculation of the time between the signal being received at the fieldbus interface and the output switching when a fault is present:

$$\text{OFDT}_{\text{Output}} = \text{WCDT}_{\text{Output}}$$

Device Acknowledge Time (DAT)

Calculation of the time between the signal being received at the fieldbus interface, the signal being confirmed and the confirmed signal being available at the fieldbus interface:

$$\text{DAT} = 6 \text{ ms}$$

6 Web application

The device has an integrated, browser-based web application. The web application enables device functions to be executed without using PASconfig and can be used for the following tasks:

- ▶ Call up device information
- ▶ List diagnostic information (error stack)
- ▶ Display and configure network settings
- ▶ Perform the wiring test
- ▶ Manage access data
- ▶ Web server settings (TLS certificate, activation)
- ▶ Call up support information

The following browsers have been tested with the web application and the operating system Microsoft Windows 10:









- ▶ Microsoft Edge: 95.0.1020.40 (64-bit)
- ▶ Google Chrome: 96.0.4664.110 (64-bit)
- ▶ Mozilla Firefox: 91.4.1esr (64-bit)

6.1 Pre-defined user name





Two default users are defined on the device; these cannot be changed (note that the user name is written in lower case):

- ▶ admin (administrator)
- ▶ guest (user with read rights)

Applications of the administrator (admin)

- ▶ [Logging in to the web application](#)  56
- ▶ [Start page](#)  59
- ▶ [Display diagnostics](#)  61
- ▶ [Configuring the network](#)  63
- ▶ [Performing the wiring test](#)  64
- ▶ [Managing users](#)  67
- ▶ [Settings](#)  68
- ▶ [Support](#)  70

Applications of the user with read rights (guest)

- ▶ [Logging in to the web application](#)  56
- ▶ [Start page](#)  59
- ▶ [Display diagnostics](#)  61
- ▶ [Support](#)  70



6.2 Logging in to the web application

The web application can be called up under the device's IP address using a browser.

Prerequisites

- ▶ The device's IP address is configured and known.
- ▶ Your web browser allows the use of cookies.
- ▶ When you log in for the first time we recommend that you establish a point-to-point Ethernet connection between your computer and the PDP67 device. That way you can ensure that the certificate for the web application is all that is installed in your browser.
- ▶ Only one web browser may access the web application. Simultaneous access to the web application using several web browsers can lead to problems.
- ▶ PASconfig and a web browser may not access the device at the same time.

Procedure

- ▶ Enter the device's IP address `https://<Configured IP address>` in your web browser's address bar. The login page is launched. If you are using your computer to connect to the web application for the first time, then you should read the section entitled [Notes on certificates](#) [ 56].
- ▶ User name
Enter the user name here (see [Pre-defined user name](#) [ 55]).
Default value: admin
- ▶ Password
Enter the password here.
Default value (for "admin" and "guest" users): PDP67
- ▶ Language
Select the user interface language here. After logging in, the language can no longer be switched. Log out to change the language. You will be redirected to the login page and you can switch the language there.

6.2.1 Certificates

Notes on certificates

The web application establishes a safe connection (https) to your browser. When you use your browser to log in to the web application for the first time, the certificate for the web application is still unknown to the browser. The browser warns that the connection to the web application is not a safe connection. You need to create an exception rule in your browser. This process varies depending on the browser you are using. It is explained here using Microsoft Edge.

- ▶ When you load the page the following message appears: **Your connection isn't private.**

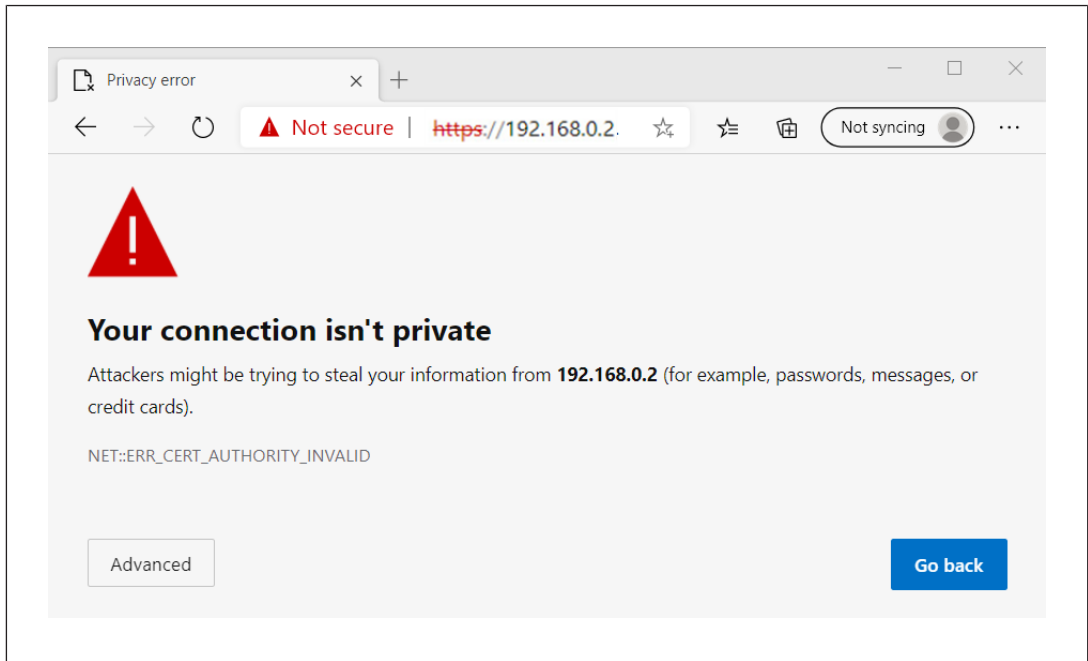

▶ Click on **Advanced**.

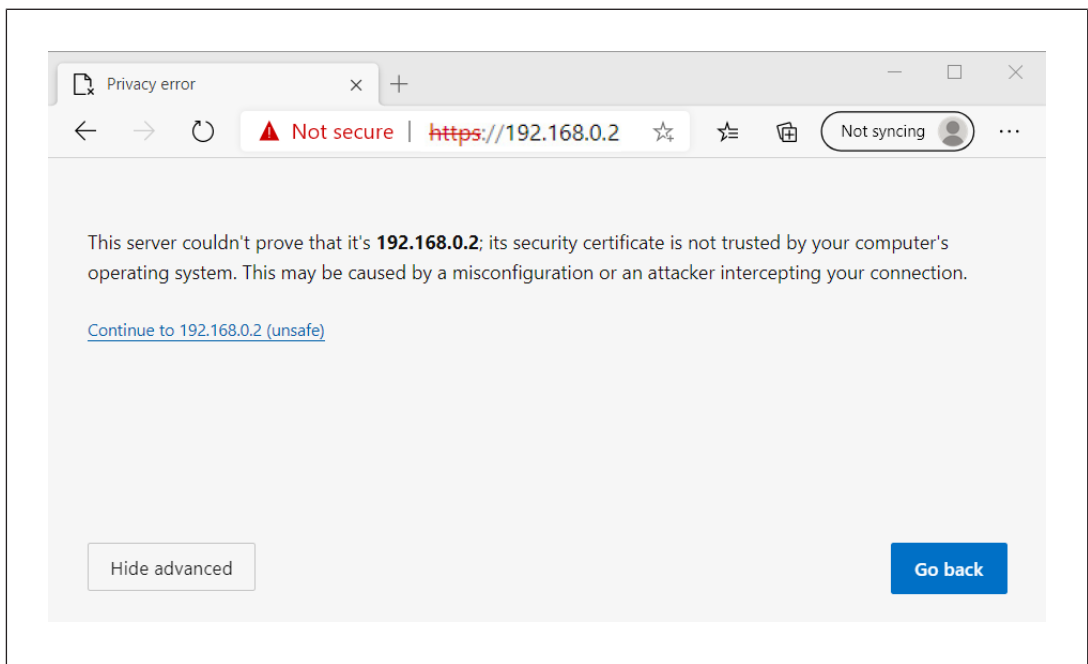

▶ Click on **Continue to <Your device's IP address> (unsafe)**. The login page is displayed.



CAUTION!

Risk of data manipulation and phishing

Adding exception rules to your browser can lead to data manipulation and phishing. Do not create exception rules for unfamiliar websites.



INFORMATION

You can also use your own certificates, if your company uses its own certificate management for example. If this is the case you can import your own certificate into the device (see also [Managing certificates](#) [ 69]).

6.3 Start page

The start page appears following a successful login.

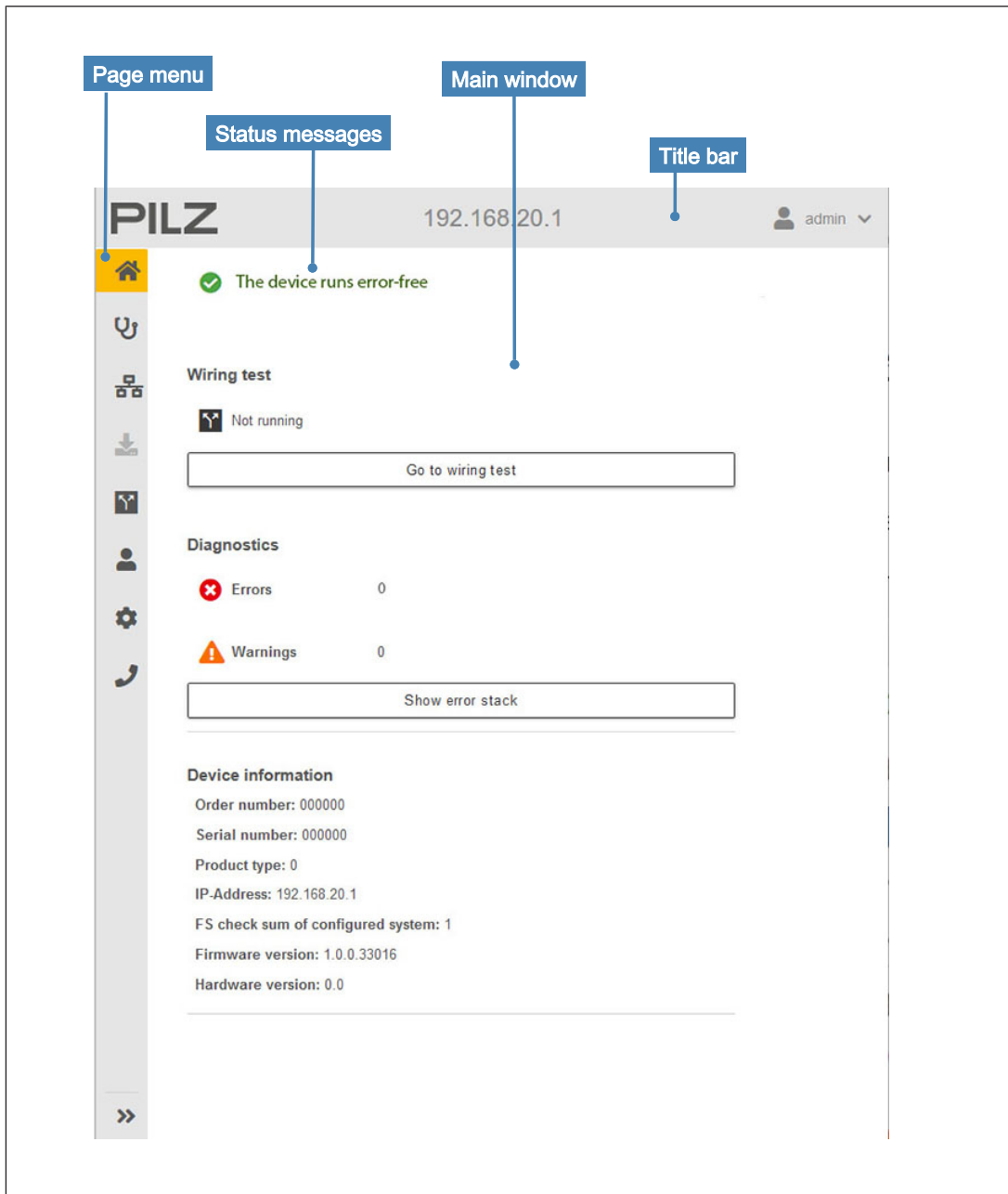

Fig.: Start page

The web application's interface is subdivided into the following sections:

► Title bar

Besides the Pilz logo, the title bar also displays the IP address of the connected device and a button with the name of the logged in user. Click on this button and select **Log out** to log out of the web application.







► Status messages and notes

Status messages appear in this area, as well as notes on a page's configurable properties.

► Page menu

The page menu display depends on the screen size. The page menu can also be collapsed or expanded manually.

Definition of icons:

Icon	Description
	Start page (the icon for the current page has a yellow background)
	Diagnostic information is displayed on this page.
	Network properties can be configured on this page.
	The wiring test can be carried out on this page.
	The passwords for the default users can be changed on this page.
	Your own certificates can be transferred to the device on this page. The pre-defined security message for the start page can be adapted here too, plus the web application can be deactivated.
	Contact information and any third party manufacturer licences are displayed on this page.

► Main window

The following information is displayed on the main window of the start page:

- Status of the wiring test with a link to the wiring test page
- Number of warning and error messages present, with a link to the diagnostic log
- Device information

6.4 Display diagnostics

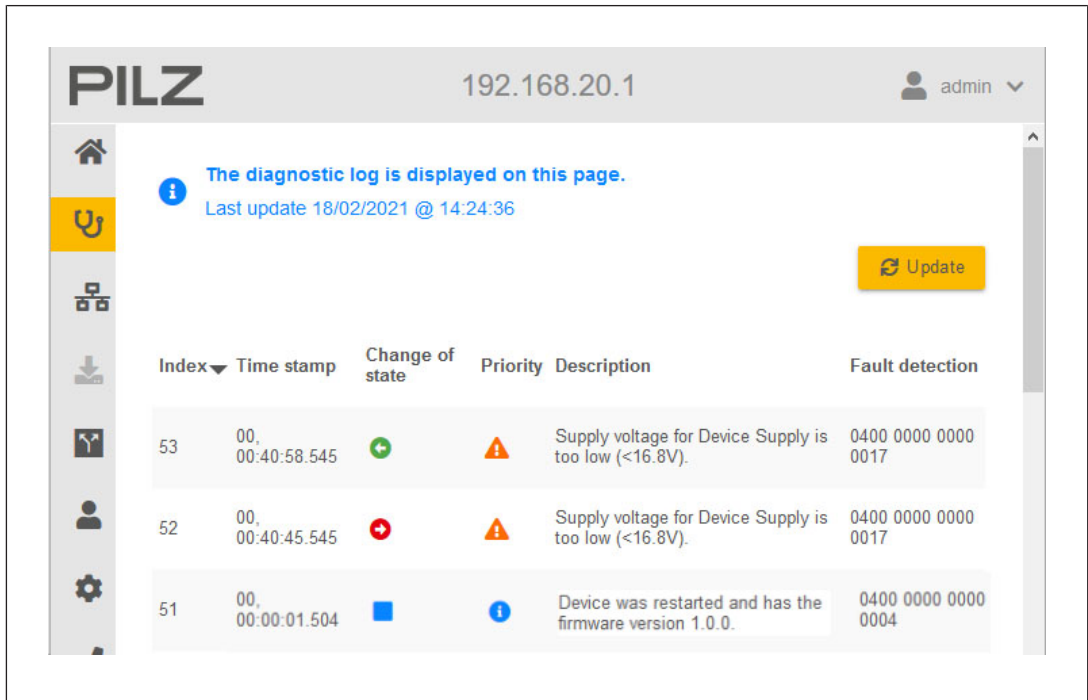

Fig.: Diagnostic page

Definition of icons:

Index column

Consecutive number

Time stamp column

Operating time, time since last restart (days, hours, minutes, seconds)



Change of state column

If an event is present (e.g. short circuit at an input), the diagnostic message becomes "active" (change of state: "arrived"). If the fault has been rectified, the diagnostic message becomes "inactive" (status change: "cleared").

Icon	Description
	Symbolises errors or warnings that have "arrived".
	Symbolises errors or warnings that have "cleared".
	Symbolises events Diagnostic messages that serve as information. Operation is not yet impeded or compromised.

Priority column

Diagnostic messages are differentiated according to their importance. They are divided into three levels of severity:

Icon	Meaning	Description
	Error	Diagnostic message to which the user must react immediately. This diagnostic message provides information on system states in which one or more functions have failed or are adversely affected
	Warning	Diagnostic message which demands the user's attention. This diagnostic message warns the user about potential or imminent critical system conditions.
	About	Diagnostic message which describes the current state of the process and/or system. This diagnostic message is provided for information; operation is neither impeded nor adversely affected.

Description column

Description of what has happened.

Fault detection column

Fault detection is used to uniquely identify a diagnostic message.

6.5 Configuring the network

The screenshot shows the network configuration interface of the PILZ web application. The header includes the PILZ logo, the IP address 192.168.20.1, and the user 'admin'. A sidebar on the left contains navigation icons. The main content area features a blue information message: 'The network properties can be changed on this page.' Below this, the following settings are displayed:

- Alias: ---
- Device name: 192.168.20.1
- F-address: 1
- IP address: 192.168.20.1
- Subnet mask: 255.255.255.0
- Gateway address: 192.168.20.1
- MAC address: 00:02:48:12:34:56

At the bottom of the configuration area, there are two buttons: 'Update' and 'Apply'.

Fig.: Configuring the network

This is where the network settings are displayed and can be configured if necessary. Please note that changes to the configuration may mean that the device is no longer accessible in the network.

Procedure

- ▶ Click on **Update** to retrieve the network configuration from the device.
- ▶ Change the network configuration and click on **Apply** to write the configuration to the device.

6.6 Performing the wiring test

The integrated wiring test provides the option to ensure the device is wired correctly. Wiring errors can be uncovered in this way, for example. The states of the inputs are displayed via the web application "Perform wiring test" and the outputs can be switched on and off.

Prerequisites

- ▶ You are logged in as administrator.
- ▶ The device has a valid IP address.
- ▶ The device does not have a configuration.
- ▶ For the hybrid IO ports X02, X04 and X06 you will need to confirm that they have been configured as an input or output in accordance with the connection diagram.



WARNING!

Risk due to the switching of outputs

The switching of outputs during the wiring test may cause hazardous states on the machine.

Ensure that nobody is endangered by switching outputs during the wiring test.

Procedure

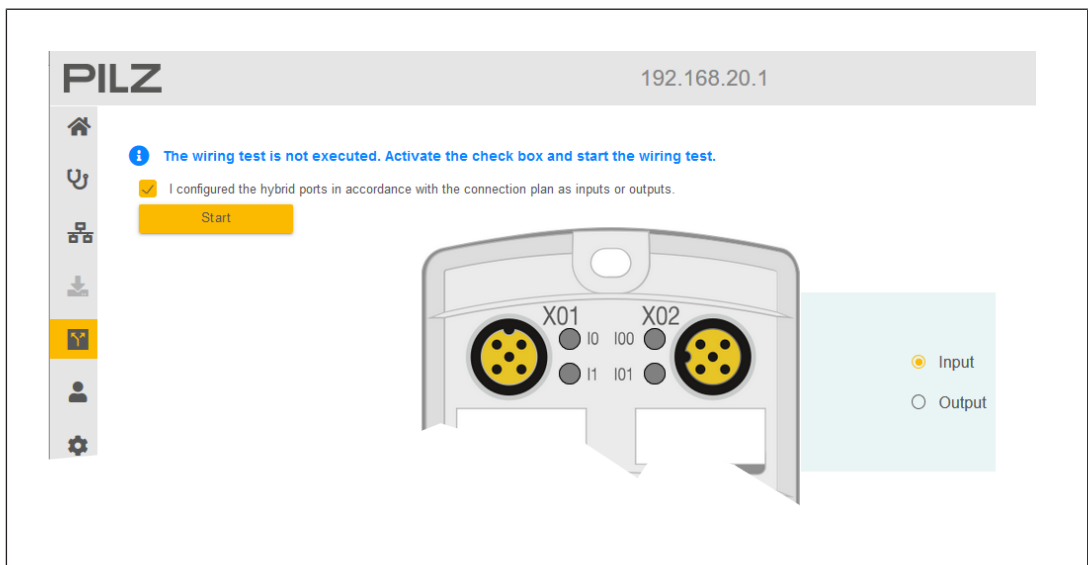

Fig.: Wiring test

- ▶ Confirm that all hybrid IO ports X02, X04 and X06 have been configured in accordance with the wiring diagram and click on **Start**. The device switches to wiring test mode and displays the current status of the inputs. When the wiring test is started, the outputs are deactivated.

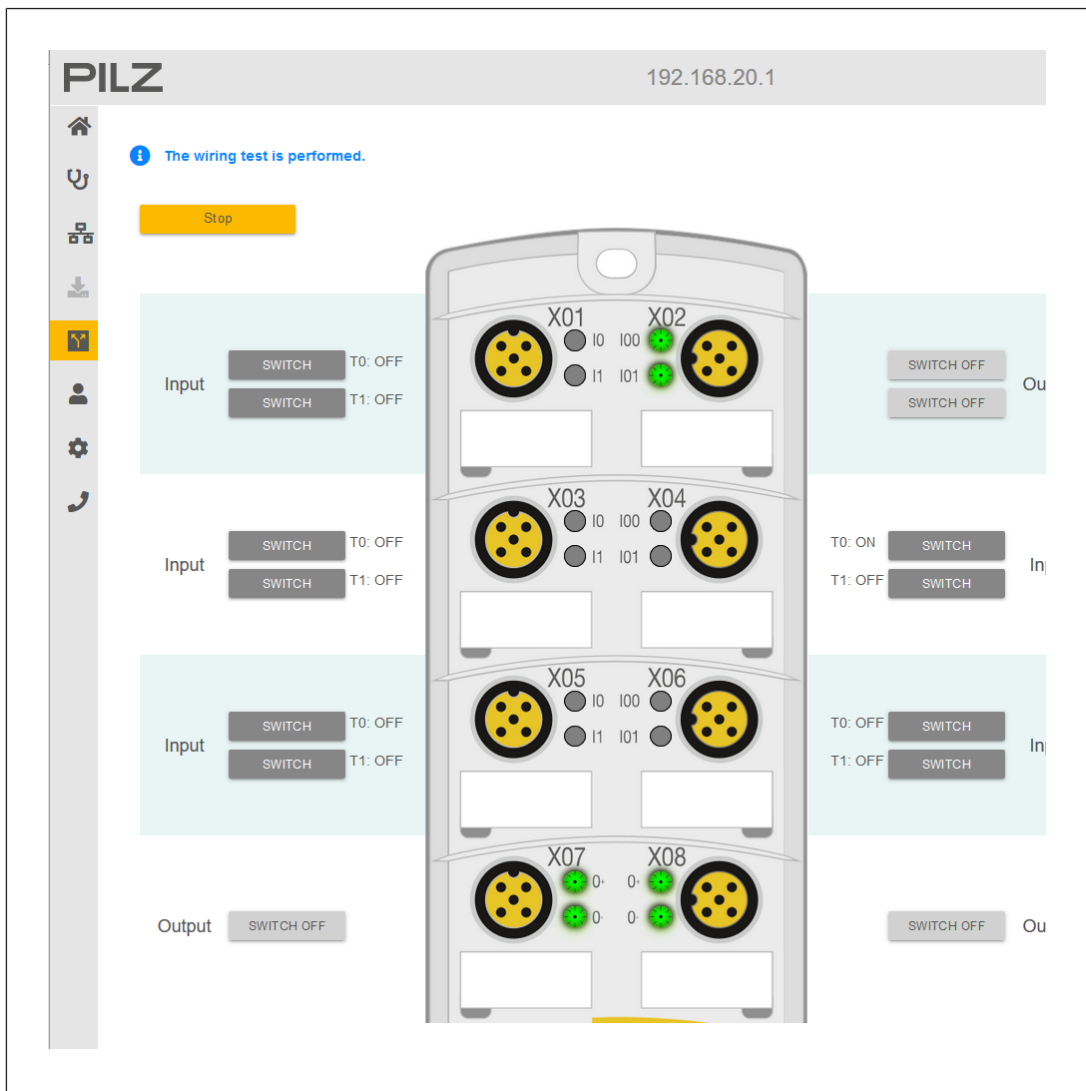

Fig.: Wiring test

Check sensor wiring

Prerequisites

- ▶ Wiring test has been started

Procedure

1. Switch on the test pulse output.
2. Activate the sensor.
3. Check that the status display at the input changes when the sensor is connected.
4. Switch off the test pulse output.

Check actuator wiring

Prerequisites

- ▶ Wiring test has been started

Procedure

- ▶ Switch on the output.

- ▶ Check that the corresponding actuator switches.
- ▶ Switch off the output.

End wiring test

- ▶ Click on Stop to end the wiring test.

The wiring test is also ended:

- ▶ By pressing the reset button
- ▶ By switching off the supply voltage
- ▶ After 2 hours have elapsed

If the wiring test is ended because the device switches to a safe state as the result of a critical error, then once the critical error has been resolved, you will need to perform a warm reset (see [Reset button](#) [ 40]) and start the wiring test again.

6.7 Managing users

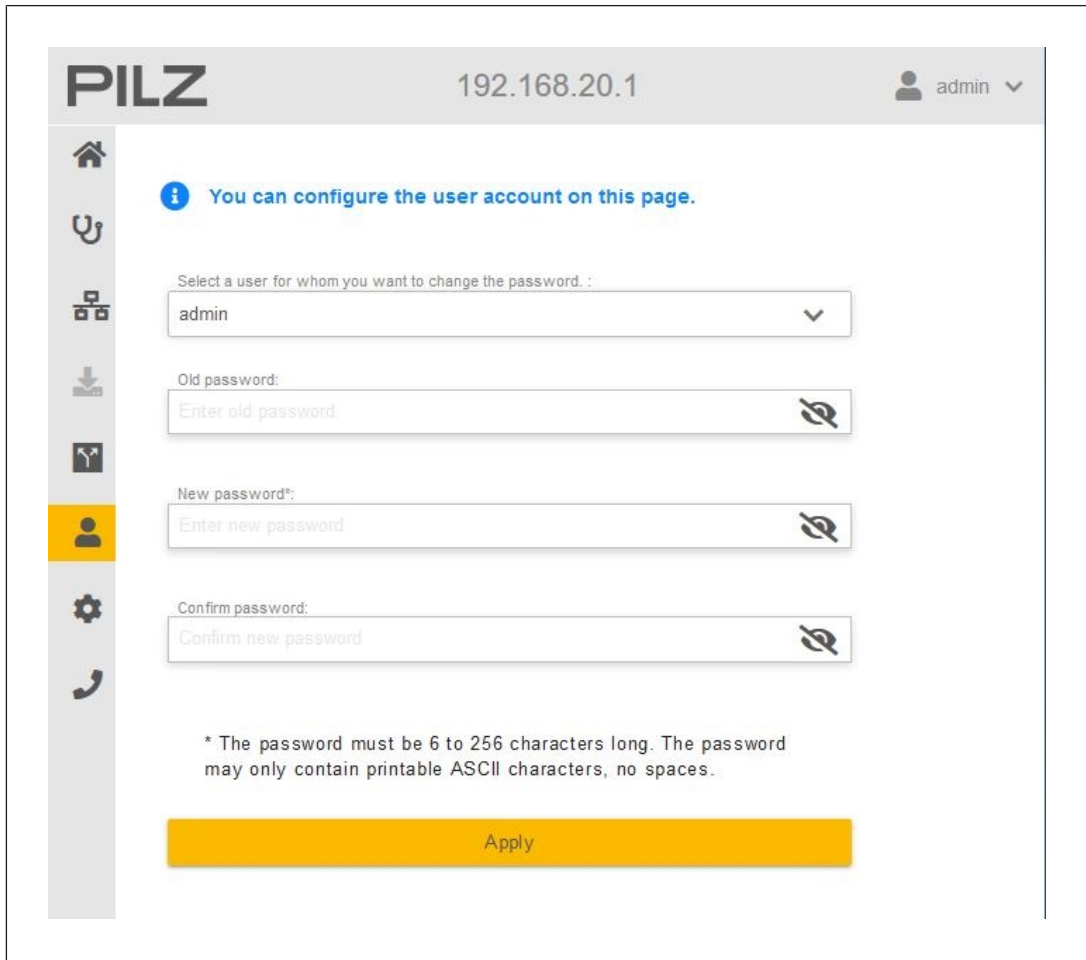

PILZ 192.168.20.1 admin

i You can configure the user account on this page.

Select a user for whom you want to change the password. :

admin

Old password:
Enter old password

New password*:
Enter new password

Confirm password:
Confirm new password

* The password must be 6 to 256 characters long. The password may only contain printable ASCII characters, no spaces.

Apply

Fig.: Change password

On this page you can change the password for the predefined users. Two default users are defined on the device; these cannot be changed (see [Pre-defined user name \[55\]](#)):

- ▶ admin (administrator)
- ▶ guest (user with read rights)

Procedure

- ▶ Select the user whose password you wish to change. Note that the user name is written in lower case.
- ▶ If you wish to change the password of the "admin" user, enter the old password. The default password for the "admin" user is **PDP67** (this is not required for the "guest" user).
- ▶ Enter a new password. The password must have at least 6 characters and may only contain ASCII characters and no spaces.
- ▶ Repeat the password and click on **Apply**.

6.8 Settings

PILZ 192.168.20.1 admin

Settings can be configured on this page.

Upload of the TLS certificate

Certificate:
Select a certificate in PEM format.

Key:
Select a key in PEM format.

Start upload

System Use Notification

This System Use Notification is displayed on the login page. The wording of this notification can be changed in the lower text field if required.

You are accessing a restricted information system. System usage may be monitored, recorded and subject to audit. Unauthorized use of the system is prohibited and may be subject to criminal and/or civil penalties. Use of the system indicates consent to monitoring and recording.

Save notification

Restore default notification



Settings

Disable web server

Fig.: Settings

On this page you can configure the following settings:

- ▶ [Managing certificates](#) [📖 69]

- ▶ [Adapting the data protection and security information](#) [ 69]
- ▶ [Deactivating the web application](#) [ 69]

6.8.1 **Managing certificates**

The web application uses X.509 certificates to secure communication between the web browser and web application.

By default the system uses a self signed CA certificate to sign the server certificate. The certificates are generated automatically by the web application.

To enable communication, the certificate is downloaded from the web application to the PC and is imported into the web browser. If you use a self-signed CA certificate, then when you try to establish a connection to the web application a warning appears, saying that the connection is not secure. To establish a connection you will need to [Add a security exception rule to your web browser](#) [ 56].

New certificates are generated when the web application is reset to its factory settings.

Certificate upload

If you want to use your own certificates, you can store the CA certificate and server certificate with its private key in the web application. As they are uploaded the certificates are checked to ensure that the syntax is correct.

Possible formats:

- ▶ PEM

Effects:

- ▶ When a CA certificate is uploaded, any existing private key will be deleted.

6.8.2 **Adapting the data protection and security information**

Data protection and security information is displayed on the login page. As the administrator and the person responsible for security, you can adapt this information to the needs of your organisation.

6.8.3 **Deactivating the web application**

Once deactivated, the web application is no longer accessible via a web browser. To reactivate the web application you will need to perform an [Original reset](#) [ 40].

6.9 Support

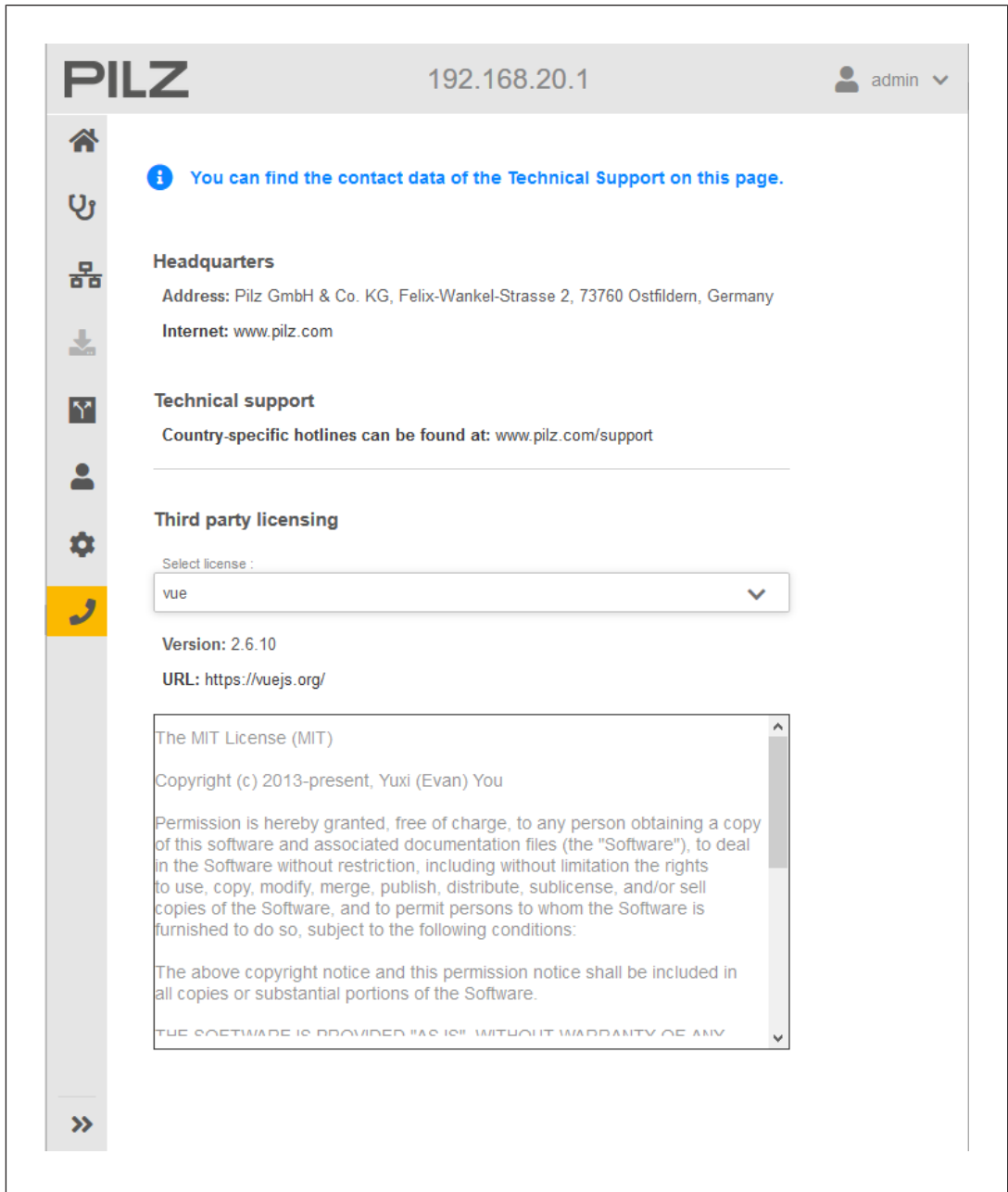

Fig.: Contact information

The Support page contains contact information for Pilz's technical support team plus the licences for the open source components that are used.

7 Installation

7.1 General installation guidelines

To meet the requirements of the protection type IP67, ensure that:

- ▶ All M12 connections are connected with a torque setting of 0.6 Nm.
- ▶ All end caps are fastened with a torque setting of 0.6 Nm. We recommend you use a torque screwdriver with PH3 bit.
- ▶ The end cap for the PDP67 removable data medium (optional) is firmly sealed.



INFORMATION

For ports X01 ... X08 and X21, X22 you should only use the end caps 380324 (colour: black), available as an option.

For port X32 you should only use the end cap 380328 (colour: grey), available as an option.

Protect the device from:

- ▶ Water or fluids with more stringent conditions than IP65/67,
- ▶ Chemicals
- ▶ Harmful substances
- ▶ Intentional damage

7.1.1 Dimensions

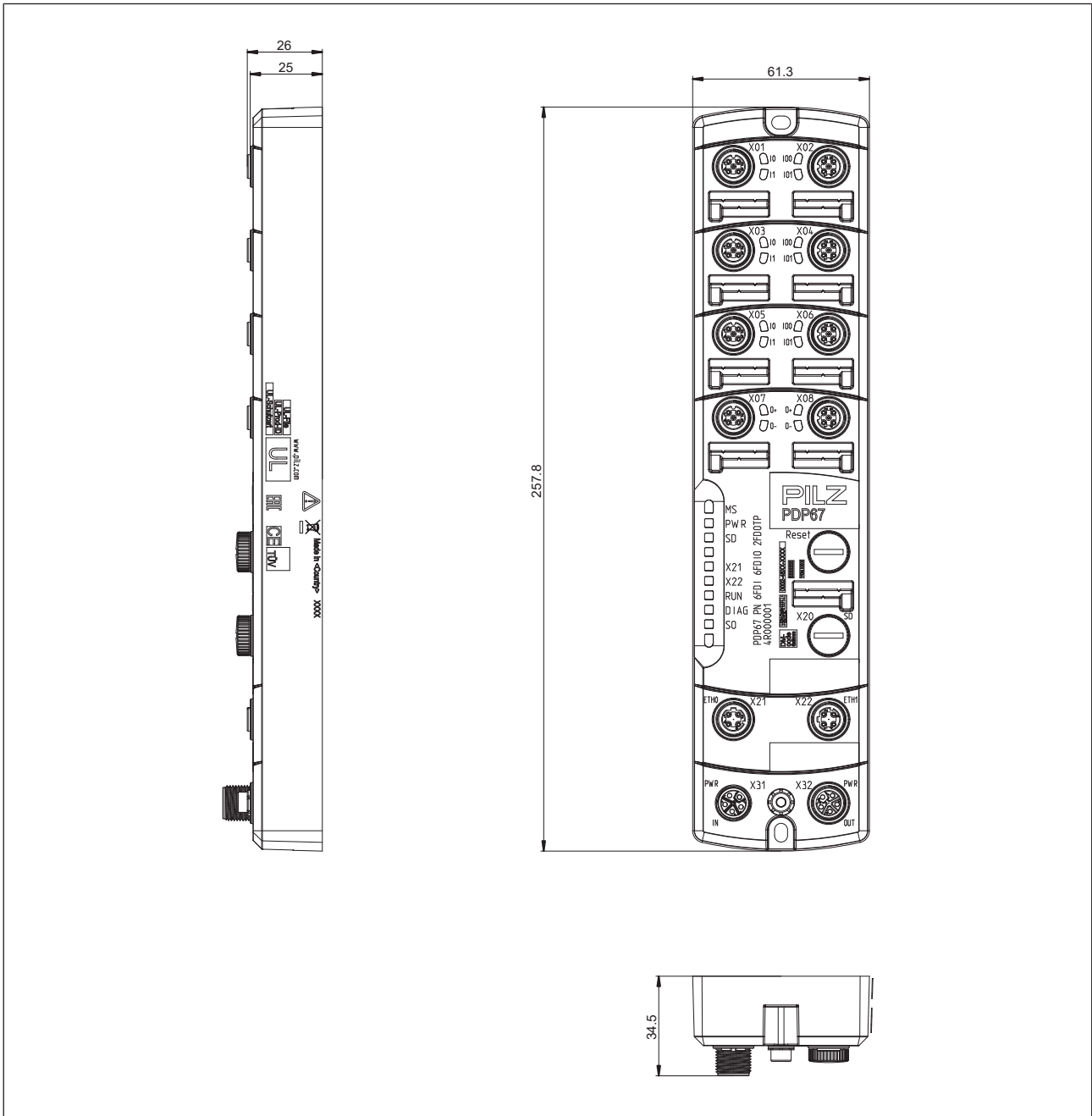

Fig.: Dimensions

7.1.2 Installing the device

The product must be fastened to a flat mounting surface, so that there is no strain on the housing when the module is screwed down. The mounting distances will depend on which plug-in connectors are used and on the bending radius of the cables.

Screws and locking washers supplied with the device:

- ▶ 1 x M4 screw for the functional earth (installed)
- ▶ 2 x M4 locking washers for the functional earth (installed)

To install the device and connect the earthing strap to the mounting surface you will need 3 x M4 screws of an appropriate length and 2 x M4 locking washers.

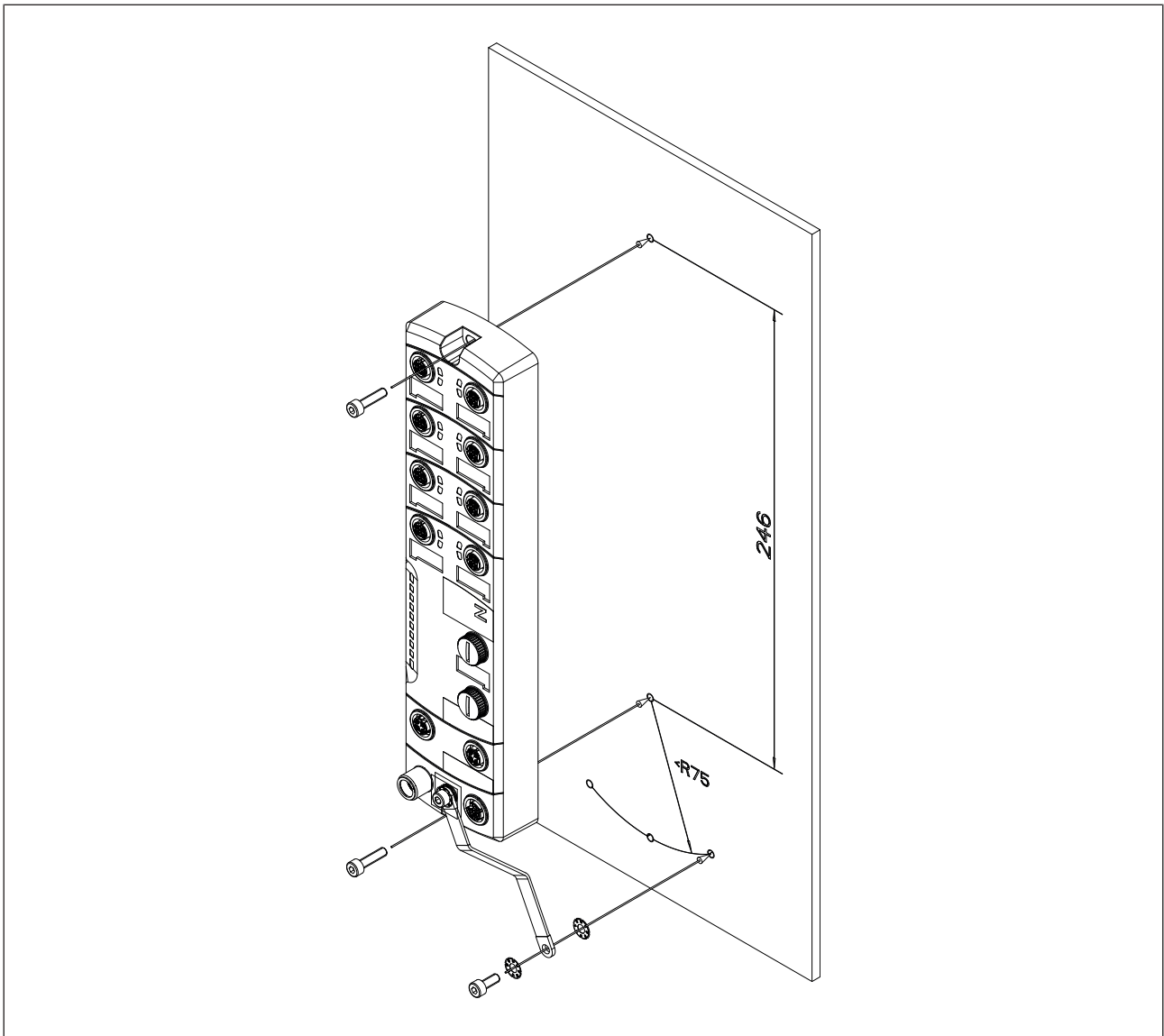



Fig.: Mounting in mm

To install the device, proceed as follows:

- ▶ Mark the drill holes and pre-drill them.
- ▶ Use fixing screws with washers. In environments with vibration we recommend that you use locking washers.
- ▶ When using internal hexagonal fixing screws with a strength class of 8.8, tighten the mounting screws with a torque setting of 2.5 Nm to 2.9 Nm.
- ▶ Use two fixing screws to attach the product to the mounting surface.

Connecting the functional earth to the earthing strap provided

The functional earth is connected to the lower fixing screw with the functional earth symbol . You can use the earthing strap provided or a separate earthing cable. If you use a separate earthing cable, the minimum conductor cross section of the earthing cable is 2.5 mm². Use fixing screws with washers. In environments with vibration we recommend that you use locking washers.

To connect the functional earth to the earthing strap provided, display, proceed as follows:

- ▶ Provide the mounting surface with an M4 internal thread (only when attaching the earthing strap to the mounting surface).
- ▶ Tighten the fixing screw on the functional earth connection  with a torque setting of 1.2 Nm. For the fixing screw you can use the M4 ratchet screw provided and the locking washer for the functional earth connection.
- ▶ Tighten the mounting screw on the mounting plate. When using an internal hexagonal fixing screw with a strength class of 8.8, tighten the screw with a torque setting of 2.5 Nm to 2.9 Nm.

8 Wiring

8.1 General wiring guidelines

Note:

- ▶ Observe the relevant standards for EMC-compliant installations.
- ▶ You must comply with the information provided under "Technical Details".
- ▶ Ensure that the sensors used for safety functions meet the required SIL value for the application.
- ▶ When selecting the sensors, make sure that the sensors' dielectric strength guarantees the required insulation against live parts. The maximum voltage permitted on the device is SELV/PELV.
- ▶ When using the FDIO ports as the FS output FDO, make sure that there is never more than 4 A flowing over Pin 3 (0 V).
- ▶ Ensure that the maximum 16 A current load capacity of ports X31 and X32 is not exceeded.
- ▶ Ensure that the application is designed in such a way that the voltage/current-free state (normally energised mode) represents the safe state.
- ▶ Use a torque setting of 0.6 Nm when connecting all M12 cables.
- ▶ To connect the wiring we recommend you use pre-assembled cable from Pilz (see [Accessories \[100\]](#)).
- ▶ Before exchanging a device, make sure that the defective device, the new device and the connectors are labelled in such a way that the connectors can clearly be assigned to the ports.



CAUTION!

The supply voltages must be protective extra low voltages with safe electrical separation (PELV or SELV). Protective separation must be ensured for the external power supplies that generate the supply voltages. Failure to do so could result in electric shock. The external power supplies must comply with the current applicable standards EN 60950-1, EN 61140, EN 50178 or EN 61558-1.



CAUTION!

In order to guarantee protection type IP67, unused plug-in connectors should be sealed using the end caps.

**CAUTION!**

Make sure that the plug-in connectors are connected to the sensors correctly. Once you have run a function test to check that the plug-in connectors are connected to the sensors and actuators correctly, the IO ports should be labelled. If the IO ports are connected to the sensors and actuators incorrectly, life-threatening situations may arise on the plant.

**WARNING!****The internal reverse polarity protection circuit is not a safety function**

A defective reverse polarity protection circuit on the device will not be detected. When making the initial connection and when recommissioning, check the correct functionality of the device's reverse polarity protection circuit.

1-channel FS inputs FDI

- ▶ The failure of a sensor will not be detected. Possible remedies:
 - Use sensors that meet the required SIL value for the application.
 - Carry out regular function tests.
 - Use 2-channel FS inputs and/or sensors.
- ▶ Short circuits between the cable to the sensor and the 24 V cable or between cables to various sensors will not be detected. Avoid short circuits through:
 - Appropriate wiring
- ▶ The input is not protected against voltages over 60V. The power supply to the sensors must meet the regulations for extra low voltages with protective electrical separation (SELV, PELV).

1-pole FS outputs FDO

- ▶ If short circuits occur between the cable from the output to the load and a supply line, it will no longer be possible to switch off the load. Avoid short circuits through:
 - Appropriate wiring
 - Using a second output as a second shutdown route

1-pole FS outputs FDO and 2-pole FS outputs FDOTP

- ▶ The failure of an actuator will not be detected. Possible remedies:
 - Use actuators that meet the required SIL value for the application
 - Carry out regular function tests
 - Use a second actuator and monitor the state of the actuator using feedback loop monitoring in the user program. If the value does not correspond to the set point, then the actuator must be switched off.

Guidelines for UL approval

UL Markings

- ▶ Use of AWG 14, min. 60 VDC, min. 16 A (X31, X32) or AWG 22 min. 22 A (X01 ... X08) required for maximum load, use copper conductors only.

8.2 Connector pin assignment

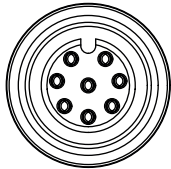
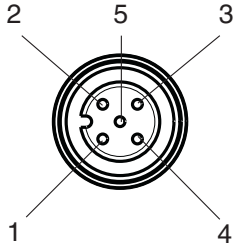
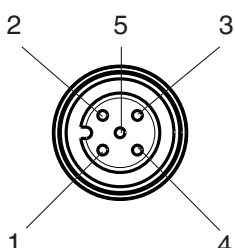
Ports X01, X03, X05	Assignment	
Type FDI : FS inputs Type: SDO : ST outputs 5-pin M12 female connector A-coded	1: Test pulse T0 / 24 VDC / ST output O0 2: FS input I1 3: 0 V 4: FS input I0 5: Test pulse T1 / 24 VDC / ST output O1 Connection to functional earth on the connector housing	
Hybrid ports X02, X04, X06	Assignment	
Type FDI : FS inputs Type FDO : FS outputs, 1-pole Type SDO : ST outputs 5-pin M12 female connector A-coded	1: Test pulse T0 / 24 VDC / ST output O0 2: FS input I1 / FS output O1 3: 0 V 4: FS input I0 / FS output O0 5: Test pulse T1 / 24 VDC / ST output O1 Connection to functional earth on the connector housing	
Ports X07 and X08	Assignment	
Type FDOTP : FS outputs, 2-pole 5-pin M12 female connector A-coded	1: n.c. 2: n.c. 3: FS output O0- (2-pole negative-switching) 4: FS output O0+ (2-pole positive-switching) 5: Connection to functional earth on pin 5 and on the connector housing	

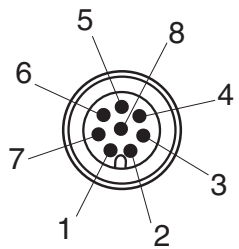
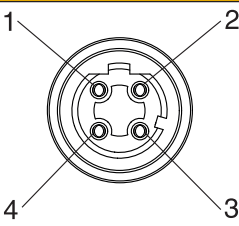
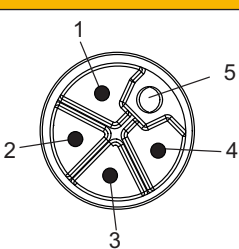
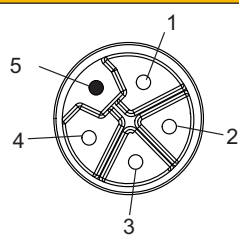
Port X20		
Connection of the PDP67 removable data medium, see under PDP67 removable data medium (available as an option)  41]		
Ports X21 and X22		Assignment
Type ETH : 2 Ethernet interfaces 4-pin M12 female connector D-coded	1: TD+ 2: RD+ 3: TD- 4: RD- Connection to functional earth on the connector housing	
Port X31		Assignment
Type PWR : Supply voltage connection 5 pin M12 male connector L-coded	1: + 24 VDC supply voltage for device supply 2: 0 V supply voltage for load supply 3: 0 V supply voltage for device supply 4: + 24 VDC supply voltage for load supply 5: Connection to functional earth	
Port X32		Assignment
Type PWR : Connection for forwarding the supply voltage 5-pin M12 female connector L-coded	1: + 24 VDC supply voltage for device supply 2: 0 V supply voltage for load supply 3: 0 V supply voltage for device supply 4: + 24 VDC supply voltage for load supply 5: Connection to functional earth.	

8.3 Connecting the supply voltage

Use a 5-pin, L-coded M12 plug-in connector to connect the device to the external supply voltage for device supply and load supply. The device has an M12 socket (X32), which is physically adjacent to the M12 connector; this is used to forward the device supply and load supply to other devices (see also [Supply voltages](#) [44]).



WARNING!

Damage to the connector

The current load capacity of the M12 connectors X31 and X32 is 16 A per feed (device supply / load supply). You must ensure that this value is not exceeded. Exceeding the permitted current load capacity can damage the plug-in connector. Please note that the supply voltage connections are not monitored for overload. Please refer to the derating diagram in the section entitled [Derating diagram](#) [51].

- ▶ If switching loads leads to disturbances on the input signals, then we recommend you use separate power supplies to supply the device supply and load supply.

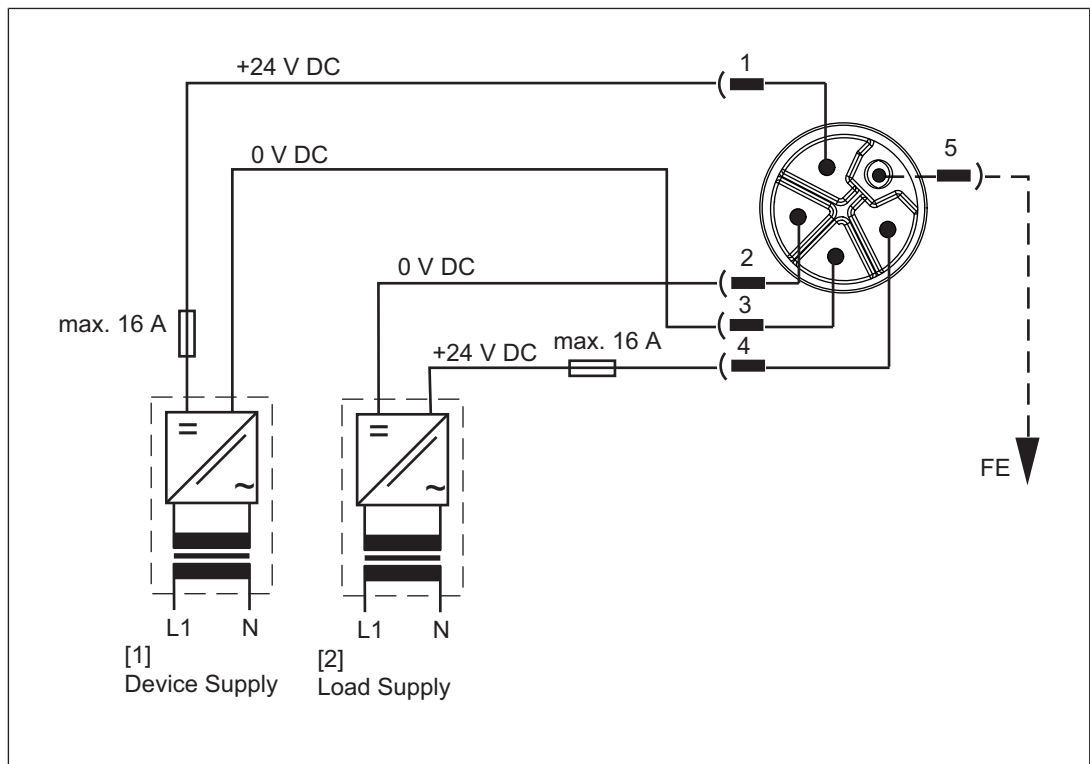

Fig.: Separate power supplies for device supply and load supply

Legend

- [1] Infeed for device supply
- [2] Infeed for load supply

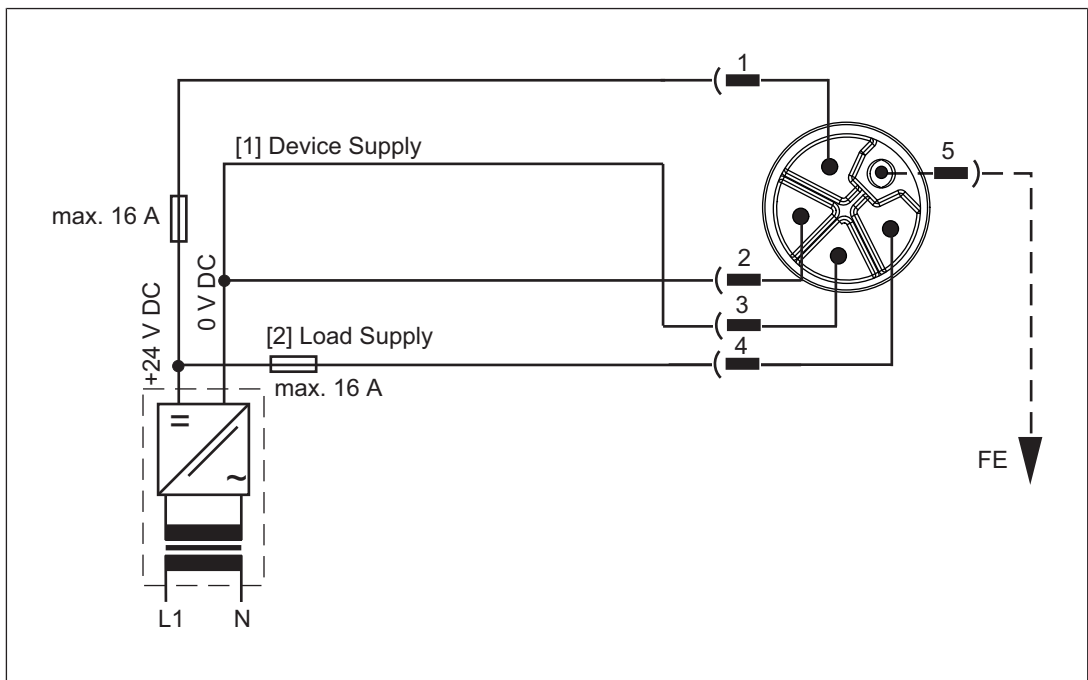

Fig.: Common power supply for device supply and load supply

Legend

- [1] Infeed for device supply
- [2] Infeed for load supply

Guidelines for UL approval

UL Markings

- ▶ The external circuits intended to be connected to this device shall be separated from MAINS supply or hazardous live voltage by reinforced or double insulation and meet the requirements of SELV/PELV (Class III) circuit of UL/CSA/IEC 61010-1, 61010-2-201.

Routing the supply voltages

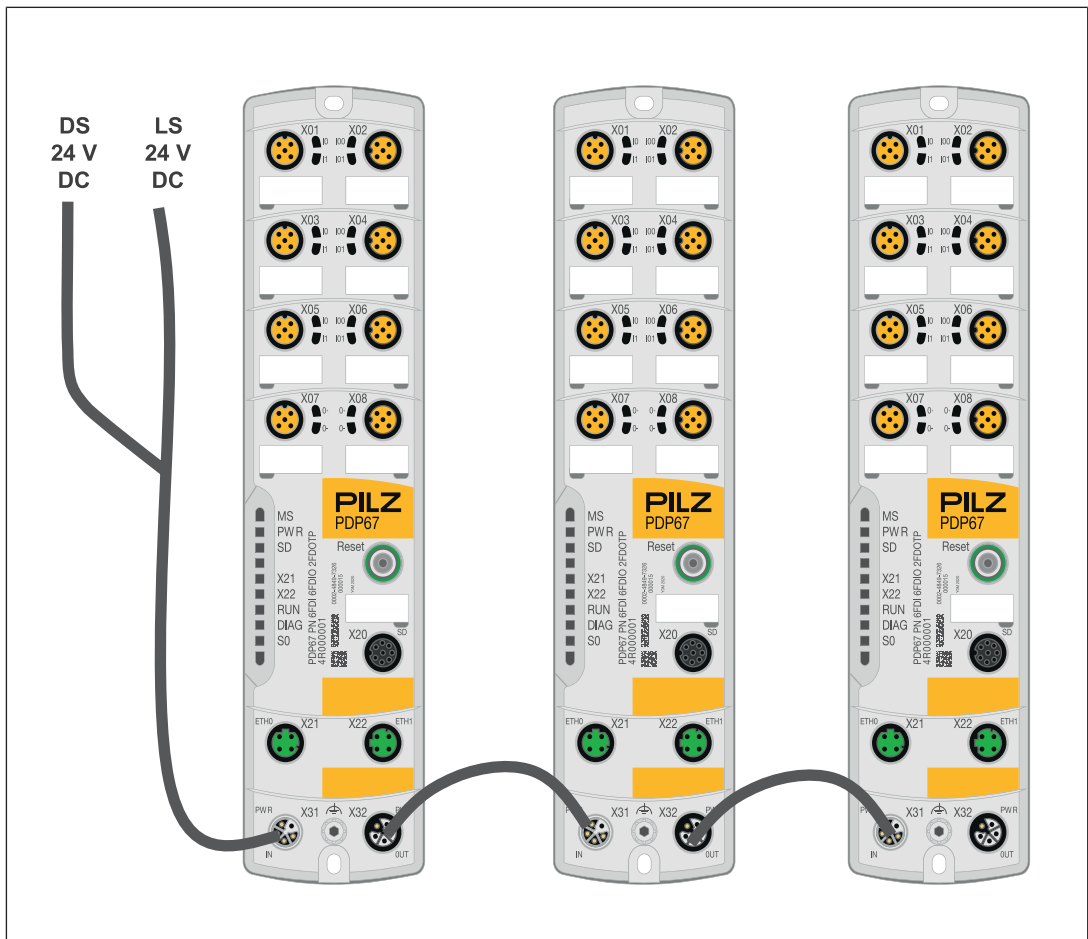



Fig.: Routing the supply voltage

8.4 Connecting the functional earth

The functional earth is used to divert electromagnetic interference.

Earth the device as follows:

Use the earthing strap provided to connect the functional earth connection on the device  to the plant's functional earth. If several devices are used, the earthing strap must be connected to each device. To install the earthing strap see [Connecting the functional earth to the earthing strap provided](#)  74].

- ▶ Connect pin 5 of the supply voltage connection PWR to the functional earth of the SELV/PELV power supply.

The connections must be low impedance and must be good conductors. Connections should be kept as short as possible. A conductor cross section of at least 2.5 mm² should be used for the connection to the central earth bar.

8.5 Connecting the fieldbus

Refer to the specifications regarding installation and wiring of PROFINET devices in the [PROFINET Installation Guidelines \(profibus.com\)](#).

8.6 Wiring examples

8.6.1 2-channel safety switch

Safety switch with volt-free contacts, equivalent, separate test pulse

Features	Connection example, PILZ safety switch
<ul style="list-style-type: none"> ▶ Configuration of test pulses: <ul style="list-style-type: none"> – I0: T1 – I1: T0 ▶ Connection to ports FDI/FDIO: <ul style="list-style-type: none"> – Channel A of the safety switch to I0 and T1 – Channel B of the safety switch to I1 and T0 	<p>The diagram shows a 5-pin terminal block with pins labeled 1 to 5. Pin 1 is connected to the top-left contact of the safety switch. Pin 2 is connected to the top-right contact. Pin 3 is connected to the bottom-left contact. Pin 4 is connected to the bottom-right contact. Pin 5 is connected to the common contact. A test pulse generator is connected to the top-left and top-right contacts.</p>
Features	Connection example, AIDA wiring
<ul style="list-style-type: none"> ▶ Configuration of test pulses: <ul style="list-style-type: none"> – I0: T0 – I1: T1 ▶ Connection to ports FDI/FDIO: <ul style="list-style-type: none"> – Channel A of the safety switch to I0 and T0 – Channel B of the safety switch to I1 and T1 	<p>The diagram shows a 5-pin terminal block with pins labeled 1 to 5. Pin 1 is connected to the top-left contact of the safety switch. Pin 2 is connected to the top-right contact. Pin 3 is connected to the bottom-left contact. Pin 4 is connected to the bottom-right contact. Pin 5 is connected to the common contact. A test pulse generator is connected to the top-left and bottom-left contacts.</p>

Safety switch with volt-free contacts, equivalent, shared test pulse

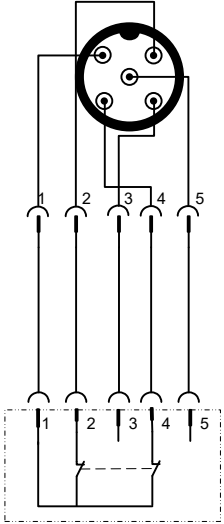
Features	Connection example, AIDA wiring
<p>► Configuration of test pulses:</p> <ul style="list-style-type: none"> – I0: T0 – I1: T0 <p>► Connection to ports FDI/FDIO:</p> <ul style="list-style-type: none"> – Channel A of the safety switch to I0 and T0 – Channel B of the safety switch to I1 and T0 	



WARNING!

Use of shared test pulse

Short circuits between the cable from the test pulse to the sensor and the cable from the sensor to the input or between cables to various sensors will not be detected. Depending on the application, serious injury or death may result.

Avoid short circuits through

- Appropriate wiring
- Wiring in accordance with the requirements of IEC 61076-2-101 and IEC 60204-1, clause 14.1.1 and 14.1.2

Safety switch with electronic OSSD outputs, equivalent, no test pulse

Features	Connection example, AIDA sensor
<p>► Configuration of test pulses:</p> <ul style="list-style-type: none"> – T0: 24 V – T1: 24 V – I0 -> Test pulse: No test pulse – I0 -> Test pulse: No test pulse <p>► Connection to ports FDI/FDIO:</p> <ul style="list-style-type: none"> – OSSD1 to I0 – OSSD2 to I1 – Safety switch supplied with 24 VDC through voltage output T0 	

8.6.2 1-channel actuators

Actuator, 1-pole switching

Features	Connection example
<p>► Connection to ports FDO:</p> <ul style="list-style-type: none"> – Actuator to output O0 and 0V 	

Actuator, 2-pole switching

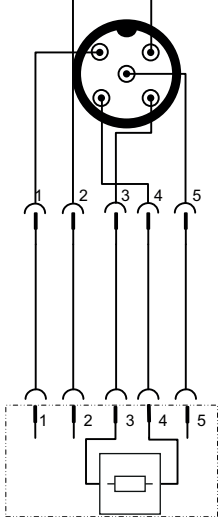
Features	Connection example
<p>▶ Connection to ports FDOTP: – Actuator to output O0+ and O0-</p>	

9 Operation

9.1 Display elements

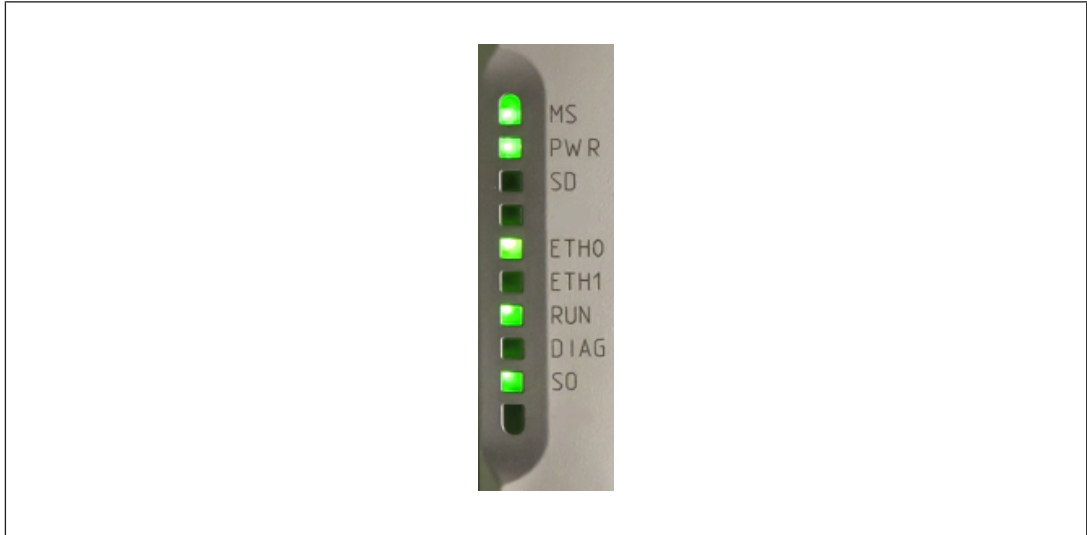











Fig.: LEDs

Legend

-  LED on
-  LED flashes
-  LED flashes
-  LED off



9.1.1 MS

This "MS" LED indicates the device status.

Colour	State	Meaning
- - -		No supply voltage/not ready for operation
Green		Device is ready for operation
Green		Device in operation
Red		Device error, device is in a safe state, there is a diagnostic entry in the diagnostic log (see Read diagnostic log [91]). A restart is required (warm reset, see Reset button [40]) once the error is rectified.
Yellow		Wiring test mode active
Red		Updating firmware



9.1.2 PWR

The "PWR" LED indicates the status of the load and device supply.

Colour	State	Meaning
- - -		No supply voltage
Yellow		Load supply or device supply faulty
Green		Load supply and device supply ok

9.1.3 SD



The "SD" LED indicates the status of the removable data medium.

Colour	State	Meaning
---		No PDP67 removable data medium
Yellow		Confirmation for accepting the device project and configuration expected
Green		PDP67 removable data medium present

9.1.4 ETH0 (X21), ETH1 (X22)



These status LEDs are the display elements for the interfaces (X21 and X22). Each of the two interfaces is assigned an LED.

X21, X22

Colour	State	Meaning
---		No network connection
Green		Network connection present
Green		Data traffic is error-free



9.1.5 RUN

The "RUN" LED indicates the status of the PROFINET interface.

Colour	State	Meaning
---		No PROFINET connection
Green		PROFINET connection available
Green		Device does not yet have a device name



9.1.6 DIAG

The "DIAG" LED indicates recoverable errors/malfunctions.

Colour	State	Meaning
Red		Recoverable error/malfunction, there is a diagnostic entry in the diagnostic log (see Read diagnostic log [91])
---		No recoverable error/malfunction present



9.1.7 SO - Safe Operation

The "SO" LED indicates the status of the PROFIsafe interface.

Colour	State	Meaning
---		<ul style="list-style-type: none"> ▶ F-parameter error ▶ F-host inactive
Green		▶ PROFIsafe is in operation
Green		▶ PROFIsafe requires reintegration.

9.1.8 LEDs at the IO ports of the inputs and outputs

These LEDs indicate the status of the inputs and outputs.

Colour	State	Meaning
---		The pin was not activated or Device in operation and: <ul style="list-style-type: none"> ▶ with inputs: a "0" signal is present ▶ with outputs: a "0" signal is emitted
Green		Device in operation and <ul style="list-style-type: none"> ▶ with inputs: a "1" signal is present ▶ with outputs: a "1" signal is emitted
Green		An error is present, there is a diagnostic entry in the diagnostic log (see Read diagnostic log [91]).

9.2 Diagnostics

The device offers various options for diagnostics and fault detection.

Diagnostics for the device can be run via

- ▶ The LEDs on the device (see [Display elements](#)  87)
- ▶ And the device's own diagnostic log.

The device provides the following diagnostic data:

- ▶ Start-up error
- ▶ Configuration error
- ▶ FS communication error
- ▶ Temperature warning: too warm, low
- ▶ Temperature error: too hot, too low
- ▶ Output error
- ▶ Test pulse error
- ▶ Input error
- ▶ Undervoltage
- ▶ Overvoltage

9.2.1 Read diagnostic log

All errors and malfunctions detected by the device are entered in the diagnostic log. You can read the device's diagnostic log using PASconfig (see PASconfig online help) or the web application (see [Display diagnostics](#)  61).

9.2.2 Remedies

Remedies are available in PASconfig via the diagnostic log (see PASconfig online help).

10 Maintenance and testing

It is not necessary to perform maintenance work on the product in normal operation. Please return any faulty products to Pilz.

11 Technical details

General	
Certifications	CE, EAC, TÜV, UKCA
Application range	Failsafe
Number of FS input bits	12
Number of FS output bits	8
Electrical data	
Supply voltage	
for	Device supply
Voltage	24 V
Kind	DC
Voltage tolerance	-30 %/+25 %
Output of external power supply (DC)	480 W
Output of external power supply (DC) at no load	7 W
Residual ripple DC	5 %
Potential isolation	yes
SELV/PELV required	yes
Supply voltage	
for	Load Supply
Voltage	24 V
Kind	DC
Voltage tolerance	-30 %/+25 %
Output of external power supply (DC)	480 W
Output of external power supply (DC) at no load	1 W
Residual ripple DC	5 %
Potential isolation	yes
SELV/PELV required	yes
Inputs	
Number	6 - 12
Signal level at "0"	-3 - +5 V DC
Signal level at "1"	11 - 30 V DC
Voltage at inputs	24 V DC
Input type in accordance with EN 61131-2	1, 3
Input current range	3 - 4,8 mA
Software filter time	0 ms ... 10 ms
Potential isolation	yes
Corresponding supply voltage	Device Supply
Semiconductor outputs	
Number of positive-switching single-pole semiconductor outputs	6
Output type in accordance with EN 61131-2	2
Max. power consumption	2 W
Corresponding supply voltage	Device Supply

Semiconductor outputs

Typ. output current at "1" signal and rated voltage of semiconductor output	2 A
Permitted current range	0,000 - 2,500 A
Residual current at "0" signal	0,3 mA
Max. internal voltage drop	810 mV
Max. duration of on time during self test	100 - 12700 µs
Max. duration of off time during self test	100 - 12700 µs
Potential isolation	yes
Short circuit-proof	yes
Permitted loads	inductive, capacitive, resistive
Output rating acc. to UL 61010-1	general use, pilot duty, resistive

Semiconductor outputs, 2-pole

Number of dual-pole semiconductor outputs	2
Output type in accordance with EN 61131-2	2
Permitted current range	0,00 - 2,50 A
Typ. output current at "1" signal and rated voltage of semiconductor output	2 A
Max. power consumption	0,63 W
Corresponding supply voltage	Load Supply
Residual current at "0" signal	0,03 mA
Short circuit-proof	yes
Permitted loads	inductive, capacitive, resistive
Output rating acc. to UL 61010-1	general use, pilot duty, resistive

Test pulse outputs

Number of test pulse outputs	12
Configurable as	24 V DC, ST output, test pulse output
Voltage, test pulse outputs	24 V DC
Corresponding supply voltage	Device Supply
Short circuit-proof	yes
Number of outputs that can be configured as test pulses	12
Max. output current at "1" signal	0,62 A
Typ. output current at "1" signal and rated voltage of test pulse output	0,5 A
Potential isolation	yes

PROFINET interface

Number	2
PROFINET IO specification	V2.33
Conformance Class	C
Network load class	III
Protocol version	V2.6
Input device	1.440 Byte
Output	1.440 Byte
Transmission rates	100 MBit/s
Transmission rate selectable via	Automatic

PROFINET interface	
Certification	PNO
Manufacturer's ID	092Fh
Connection	M12
Device type	IO-Device
Environmental data	
Climatic suitability	EN 60068-2-1, EN 60068-2-14, EN 60068-2-2, EN 60068-2-30, EN 60068-2-78
Ambient temperature	
In accordance with the standard	EN 60068-2-14
Temperature range	-30 - 70 °C
Max. temperature in accordance with UL	-30 - 60 °C
Storage temperature	
In accordance with the standard	EN 60068-2-1/-2
Temperature range	-40 - 70 °C
Climatic suitability	
In accordance with the standard	EN 60068-2-78
Humidity	93 % r. h. at 40 °C
Condensation during operation	Short-term
Max. operating height above sea level	5000 m
EMC	EN 61131-2 (Zone B)
Vibration	
In accordance with the standard	EN 60068-2-6
Frequency	8,4 - 150 Hz
Acceleration	50 m/s²
Shock stress	
In accordance with the standard	EN 60068-2-27
Number of shocks	3
Acceleration	200 m/s²
Duration	11 ms
Airgap creepage	
In accordance with the standard	EN 61131-2, UL/IEC 61010-2-201
Overvoltage category	II
Pollution degree	2
Protection type	
In accordance with the standard	EN 60529
Housing	IP67
Potential isolation	
Potential isolation between	Load supply and device supply
Type of potential isolation	Functional insulation
Rated surge voltage	1000 V
Potential isolation between	Ethernet and device supply
Type of potential isolation	Functional insulation
Rated surge voltage	1000 V
Potential isolation between	Ethernet and load supply
Type of potential isolation	Functional insulation

Potential isolation

Rated surge voltage **1000 V**

Mechanical data

Material

Housing **GD-ZnAl4Cu1**

Connection type **M12**

Mounting type **screw interlocked**

Dimensions

Height **257,8 mm**

Width **61,3 mm**

Depth **34,5 mm**

Weight **980 g**

Where standards are undated, the latest editions shall apply.

11.1 Safety characteristic data



NOTICE

You must comply with the safety characteristic data in order to achieve the required safety level for your plant/machine.

Unit	Operating mode	EN ISO 13849-1: 2015 PL	EN ISO 13849-1: 2015 Category	EN IEC 62061 SIL CL/ maximum SIL	EN IEC 62061 PFH _D [1/h]	EN/IEC 61511 SIL	EN/IEC 61511 PFD	EN ISO 13849-1: 2015 T _M [year]
------	----------------	----------------------------	----------------------------------	---	--	---------------------	---------------------	---

Input

Digital inputs	1-channel	PL d	Cat. 2	SIL CL 2	2,33E-09	SIL 2	2,04E-04	20
Digital inputs	2-channel	PL e	Cat. 4	SIL CL 3	1,25E-10	SIL 3	1,09E-05	20
Digital inputs	2-ch. pulsed	PL e	Cat. 4	SIL CL 3	8,40E-11	SIL 3	7,30E-06	20
Digital inputs	1-ch., pulsed light barrier	PL e	Cat. 4	SIL CL 3	3,05E-10	SIL 3	2,68E-05	20

Output

SC outputs (1-pole)	1-channel	PL c	Cat. 2	SIL CL 2	3,76E-10	SIL 2	3,31E-05	20
SC outputs (1-pole)	2-channel	PL e	Cat. 4	SIL CL 3	4,45E-11	SIL 3	3,90E-06	20
SC outputs (2-pole)	2-channel	PL e	Cat. 4	SIL CL 3	2,02E-10	SIL 3	1,75E-05	20

If the device is operated at an ambient temperature above 60° C, the values stated in the table for PFH_D and PFD must be multiplied by a factor of 3.5 when calculating a safety function.

All the units used within a safety function must be considered when calculating the safety characteristic data.



INFORMATION

A safety function's SIL/PL values are **not** identical to the SIL/PL values of the units that are used and may be different. We recommend that you use the PAscal software tool to calculate the safety function's SIL/PL values.

12 Supplementary data

12.1 Network data

Protocol	Direction *	Transport protocol	Port no.	Can be deactivated	Time-critical	Description
HTTP	In	TCP	0 ... 65535 Default: 80	Yes	No	User interface: Communication with a browser. The browser is always converted to HTTPS.
HTTPS	In	TCP	0 ... 65535 Default: 443	Yes	No	User interface: Secured communication with a browser. Communication is via TLSv1.2. The web server is authenticated by an X.509 certificate.
Tool interface	In	TCP	18080	No	No	Communication with the configuration tool.
PROFINET	In	UDP	161	No	No	SNMP Server port
PROFINET	In	UDP	34962	No	No	UDP Unicast port
PROFINET	In	UDP	34963	No	No	UDP Multicast port
PROFINET	In	UDP	34964	No	No	RCP Endpoint Mapper port
PROFINET	In	UDP	49152 ... 65535	No	No	Service Request ports

*

In: The communication partner starts communication with the device.

Out: The device starts communication with the communication partner.

12.2 **EC declaration of conformity**

This product/these products meet the requirements of the directive 2006/42/EC for machinery of the European Parliament and of the Council. The complete EC Declaration of Conformity is available on the Internet at www.pilz.com/downloads.

Authorised representative: Norbert Fröhlich, Pilz GmbH & Co. KG, Felix-Wankel-Str. 2, 73760 Ostfildern, Germany

12.3 **UKCA-Declaration of Conformity**

This product(s) complies with following UK legislation: Supply of Machinery (Safety) Regulation 2008.

The complete UKCA Declaration of Conformity is available on the Internet at www.pilz.com/downloads.

Representative: Pilz Automation Technology, Pilz House, Little Colliers Field, Corby, Northamptonshire, NN18 8TJ United Kingdom, eMail: mail@pilz.co.uk

13 Order reference

13.1 Product

Product type	Features	Order no.
PDP67 PN 6FDI 6FDIO 2FDOTP	PDP67, device, protection type IP67, control system I/O, failsafe and standard, 2 M12 ports, PROFINET IO DEVICE with PROFIsafe, Conformance Class C (CC-C), PROFIenergy, IRT/RT, data set I&M 0 and 1-4, digital inputs and outputs, 6/12 inputs, test pulse outputs with 24 VDC 0.25 A, 6/0 outputs, semiconductor, 0.5 A, single-pole, positive-switching, short circuit-proof, overload-proof, 2 outputs, semiconductor, 2 A, dual-pole, switches to 24 V (O0+) and 0 V (O0-), short circuit-proof, overload-proof, voltage supply, feed device supply 24 VDC XX A, feed load supply 24 VDC 8/16 A, potential isolation, functional earth connection.	4R000001

13.2 Accessories

PDP67 removable data medium

Product type	Features	Order no.
µSD memory card 512MB M12A	PDP67, accessories, microSD memory card, 512 MB, industrial design, nickel-plated brass housing, M12 connector, A-coded, for PDP67 devices	4R000002

Label plates

Product type	Features	Order no.
Acc/MA/label plates/IP67	Plastic label plates (bag of 10)	C1000033

End caps

Product type	Features	Order no.
Caps for IP67 modules	Accessories, end caps for M12 ports on PDP67 and PSS67 devices, protection type IP67, black, PU 4 pieces, only use for A- and D-coded M12 ports (380328 only for L-coded)	380324
Acc/MA/caps L-coded/M12	Accessories, end caps for M12 ports on PDP67 and PSS67 devices, protection type IP67, grey, PU 2 pieces, only use for L-coded M12 ports (380324 only for A- and D-coded)	380328

Adapter for cable

Product type	Features	Order no.
PSEN ma adapter	Cable, adapter, IP68, M12 female connector, black, straight, 4-pin, A-coded on M12 male connector, black, angled, 5-pin, A-coded, PUR, 0,1 m, 4× 0.34 mm ² , black, for connecting the sensors PSENmag (safety switch)/PIT en1.0 (enabling switch) to PSS67 and PDP67	380300
PSEN cs adapter	Cable, adapter, IP68, M12 female connector, black, straight, 8-pin, A-coded on M12 male connector, black, angled, 5-pin, A-coded, PUR, 0,1 m, 4× 0.25 mm ² , black, with shielding (wire mesh), for connecting a PSENcode sensor (coded safety switch) to PSS67 and PDP67	380301
Adapter/ML/M12-5SMX/ M12-5SMX/M12-8SFX/XX	Y adapter for connecting PSEN ml b or PSEN ml s to PDP67 PN 6FDI 6FDIO 2FDOTP, 1 x 8-pin M12 female connector, straight, A-coded on 2 x 5-pin M12 male connector, straight, A-coded	C1000059

Ethernet cable

Product type	Features	Order no.
Cable/PN/RJ45-4SM/ M12-4SMX/D/003/Q324/ GN	Ethernet cable, M12 connector, 4-pin, D-coded, RJ45 connector, PUR shielded green, suitable for drag chains, 3 m	C1000001
Cable/PN/RJ45-4SM/ M12-4SMX/D/005/Q324/ GN	Ethernet cable, M12 connector, 4-pin, D-coded, RJ45 connector, PUR shielded green, suitable for drag chains, 5 m	C1000002
Cable/PN/RJ45-4SM/ M12-4SMX/D/010/Q324/ GN	Ethernet cable, M12 connector, 4-pin, D-coded, RJ45 connector, PUR shielded green, suitable for drag chains, 10 m	C1000003
Cable/PN/RJ45-4SM/ M12-4SMX/D/020/Q324/ GN	Ethernet cable, M12 connector, 4-pin, D-coded, RJ45 connector, PUR shielded green, suitable for drag chains, 20 m	C1000004
Cable/PN/M12-4SMX/ M12-4SMX/D/0.5/Q324/ GN	Ethernet cable, M12 connector, 4-pin, D-coded, M12 connector, PUR shielded green, suitable for drag chains, 0.5 m	C1000005
Cable/PN/M12-4SMX/ M12-4SMX/D/003/Q324/ GN	Ethernet cable, M12 connector, 4-pin, D-coded, M12 connector, PUR shielded green, suitable for drag chains, 3 m	C1000006
Cable/PN/M12-4SMX/ M12-4SMX/D/005/Q324/ GN	Ethernet cable, M12 connector, 4-pin, D-coded, M12 connector, PUR shielded green, suitable for drag chains, 5 m	C1000007
Cable/PN/M12-4SMX/ M12-4SMX/D/010/Q324/ GN	Ethernet cable, M12 connector, 4-pin, D-coded, M12 connector, PUR shielded green, suitable for drag chains, 10 m	C1000008

Product type	Features	Order no.
Cable/PN/M12-4SMX/ M12-4SMX/D/020/Q324/ GN	Ethernet cable, M12 connector, 4-pin, D-coded, M12 connector, PUR shielded green, suitable for drag chains, 20 m	C1000009

Cable for supply voltage

Product type	Features	Order no.
Cable/PW/M12-5SMX/ M12-5SFX/L/0,5/1Q50/BK	Power supply cable, M12 connector, 5-pin, L-coded, M12 socket, PUR black, suitable for drag chains, 5× 1.5 mm ² , 0.5 m	C1000010
Cable/PW/M12-5SMX/ M12-5SFX/L/003/1Q50/BK	Power supply cable, M12 connector, 5-pin, L-coded, M12 socket, PUR black, suitable for drag chains, 5× 1.5 mm ² , 3 m	C1000011
Cable/PW/M12-5SMX/ M12-5SFX/L/005/1Q50/BK	Power supply cable, M12 connector, 5-pin, L-coded, M12 socket, PUR black, suitable for drag chains, 5× 1.5 mm ² , 5 m	C1000012
Cable/PW/M12-5SMX/ M12-5SFX/L/010/1Q50/BK	Power supply cable, M12 connector, 5-pin, L-coded, M12 socket, PUR black, suitable for drag chains, 5× 1.5 mm ² , 10 m	C1000013
Cable/PW/M12-5SMX/ M12-5SFX/L/020/1Q50/BK	Power supply cable, M12 connector, 5-pin, L-coded, M12 socket, PUR black, suitable for drag chains, 5× 1.5 mm ² , 20 m	C1000014
Cable/PW/M12-5SFX/ XXX-5XXX/L/003/1Q50/ BK	Power supply cable, M12 socket, 5-pin, L-coded, open cable end, PUR black, suitable for drag chains, 5× 1.5 mm ² , 3 m	C1000027
Cable/PW/M12-5SFX/ XXX-5XXX/L/005/1Q50/ BK	Power supply cable, M12 socket, 5-pin, L-coded, open cable end, PUR black, suitable for drag chains, 5× 1.5 mm ² , 5 m	C1000028
Cable/PW/M12-5SFX/ XXX-5XXX/L/010/1Q50/ BK	Power supply cable, M12 socket, 5-pin, L-coded, open cable end, PUR black, suitable for drag chains, 5× 1.5 mm ² , 10 m	C1000029
Cable/PW/M12-5SFX/ XXX-5XXX/L/020/1Q50/ BK	Power supply cable, M12 socket, 5-pin, L-coded, open cable end, PUR black, suitable for drag chains, 5× 1.5 mm ² , 20 m	C1000030
Supply cable 5x1.5	By the metre, PVC (90°C to UL 1581), black RAL9005, 5x1.5, UV-resistant IEC 603323-3-24 (cat. C), 1000V UL/CSA, colour of the single wires: 1 grey wire, 4 black wires with white digits. Suitable for laying in dry, damp or wet rooms (also water-oil mixtures), outdoor, nor suitable for burial underground. Minimum order quantity: 10 m	380327
Cable/PW/M12-5SMX/ M12-5SFX/L/0,5/2Q50/BK	Power supply cable, 5-pin M12 male connector, straight, L-coded on 5-pin M12 female connector, straight, L-coded, conductor cross section: 5 x 2.5 mm ² , 16 A, cable length: 0.5 m	C1000060

Product type	Features	Order no.
Cable/PW/M12-5SMX/ M12-5SFX/L/003/2Q50/BK	Power supply cable, 5-pin M12 male connector, straight, L-coded on 5-pin M12 female connector, straight, L-coded, conductor cross section: 5 x 2.5 mm ² , 16 A, cable length: 3 m	C1000061
Cable/PW/M12-5SFX/ XXX-5XXX/L/010/2Q50/ BK	Power supply cable, 5-pin M12 female connector, straight, L-coded, open cable end conductor cross section: 5 x 2.5 mm ² , 16 A, cable length: 10 m	C1000062

Cable for sensors and actuators

Product type	Features	Order no.
Cable/FC/M12-5SMX/ M12-5SFX/A/0,5/0Q34/BK	Field connection cable, straight M12 connector, 5-pin, A-coded, straight M12 socket, PUR, suitable for drag chains, 5 x 0.34 mm ² , 0.5 m, IOL-S compatible	C1000015
Cable/FC/M12-5SMX/ M12-5SFX/A/003/0Q34/ BK	Field connection cable, straight M12 connector, 5-pin, A-coded, straight M12 socket, PUR, suitable for drag chains, 5 x 0.34 mm ² , 3 m, IOL-S compatible	C1000016
Cable/FC/M12-5SMX/ M12-5SFX/A/005/0Q34/ BK	Field connection cable, straight M12 connector, 5-pin, A-coded, straight M12 socket, PUR, suitable for drag chains, 5 x 0.34 mm ² , 5 m, IOL-S compatible	C1000017
Cable/FC/M12-5SMX/ M12-5SFX/A/010/0Q34/ BK	Field connection cable, straight M12 connector, 5-pin, A-coded, straight M12 socket, PUR suitable for drag chains, 5 x 0.34 mm ² , 10 m, IOL-S compatible	C1000018
Cable/FC/M12-5SMX/ M12-5SFX/A/020/0Q34/ BK	Field connection cable, straight M12 connector, 5-pin, A-coded, straight M12 socket, PUR, suitable for drag chains, 5 x 0.34 mm ² , 20 m, IOL-S compatible	C1000019
Cable/FC/M12-5SMX/ M12-5SFX/A/030/0Q34/ BK	Field connection cable, straight M12 connector, 5-pin, A-coded, straight M12 socket, PUR, suitable for drag chains, 5 x 0.34 mm ² , 30 m	C1000020
Cable/FC/M12-5AMX/ M12-5SFX/A/0.5/0Q34/BK	Field connection cable, angled M12 connector, 5-pin, A-coded, straight M12 socket, PUR, suitable for drag chains, 5 x 0.34 mm ² , 0.5 m, IOL-S compatible	C1000021
Cable/FC/M12-5AMX/ M12-5SFX/A/003/0Q34/ BK	Field connection cable, angled M12 connector, 5-pin, A-coded, straight M12 socket, PUR, suitable for drag chains, 5 x 0.34 mm ² , 3 m, IOL-S compatible	C1000022
Cable/FC/M12-5AMX/ M12-5SFX/A/005/0Q34/ BK	Field connection cable, angled M12 connector, 5-pin, A-coded, straight M12 socket, PUR, suitable for drag chains, 5 x 0.34 mm ² , 5 m, IOL-S compatible	C1000023

Product type	Features	Order no.
Cable/FC/M12-5AMX/ M12-5SFX/A/010/0Q34/ BK	Field connection cable, angled M12 connector, 5-pin, A-coded, straight M12 socket, PUR, suitable for drag chains, 5× 0.34 mm ² , 10 m, IOL-S compatible	C1000024
Cable/FC/M12-5AMX/ M12-5SFX/A/020/0Q34/ BK	Field connection cable, angled M12 connector, 5-pin, A-coded, straight M12 socket, PUR, suitable for drag chains, 5× 0.34 mm ² , 20 m, IOL-S compatible	C1000025
Cable/FC/M12-5AMX/ M12-5SFX/A/030/0Q34/ BK	Field connection cable, angled M12 connector, 5-pin, A-coded, straight M12 socket, PUR, suitable for drag chains, 5× 0.34 mm ² , 30 m	C1000026

Cable accessories

Product type	Features	Order no.
Stripping tool	Tool for fast and multi-stage stripping of Ethernet and SafetyNET p cables, PU 1 set.	380070
Crimping tool	Manual crimping tool used to crimp machined male and female contacts, diameter 0.08 - 2.5 mm ² , AWG 28 - 13, four-mandrel pressing, sensitive setting of the crimp measurement using an adjustment wheel, forced locking to prevent faulty crimping.	380071
PSS67 M12 connector, straight, male, 5pin	Plug-in connector, 5-pin, straight M12 connector, A-coded, screw connection, material ring nut: CuZn nickel-plated, outer cable diameter: 4 – 6 mm	380308
PSS67 M12 connector straight, female, 5pin	Plug-in connector, 5-pin, straight M12 socket, A-coded, screw connection, material ring nut: CuZn nickel-plated, outer cable diameter: 4 – 6 mm	380309
M12 con., straight, female, 5 pin, L, S	Plug-in connector, 5-pin (4+FE), shielded, straight M12 socket, L-coded (power), crimp connection, material ring nut: Die-cast zinc nickel-plated, cable screw connection Pg11, outer cable diameter 5 – 9 mm	380317
M12 con., straight, male, 4 pin, D	Plug-in connector, 4-pin, straight M12 connector, D-coded, IDC connection, material ring nut: Die-cast zinc nickel-plated, cable screw connection Pg9, outer cable diameter 6 – 8 mm	380316
M12 con., straight, male, 5 pin, L, S	Plug-in connector, 5-pin (4+FE), shielded, straight M12 socket, L-coded (power), crimp connection, material ring nut: Die-cast zinc nickel-plated, cable screw connection Pg11, outer cable diameter 5 – 9 mm	380318
PSS67 M12 connector, angled, female, 5pin	Plug-in connector, 5-pin, angled M12 socket, A-coded, screw connection, material ring nut: CuZn nickel-plated, outer cable diameter: 4 – 6 mm	380311

Product type	Features	Order no.
PSS67 M12 connector, angled, male, 5pole	Plug-in connector, 5-pin, angled M12 connector, A-coded, screw connection, material ring nut: CuZn nickel-plated, outer cable diameter: 4 – 6 mm	380310

14 Appendix

14.1 Establishing the F-address (PROFINET with PROFI-safe)

The F-address of the PROFI-safe Container on slot 11 is used as:

- ▶ F-address of the device for PROFI-safe communication in the PROFINET network
- ▶ F-address for establishing the connection to the configuration PC

A connection cannot be established to the device without the F-address. If you no longer know the F-address of a configured fieldbus device, then you can read it from the device and then use it to establish the connection to the device.

Prerequisite:

- ▶ The configuration PC is connected to the device
- ▶ You know the IP address and port number of the device

Procedure:

1. Read in the configuration of a device with an unknown F-address or create a new project in PASconfig.
2. Select **Tools** -> **Connection Manager**. The Connection Manager is started.
3. Activate your connection in the Connection Manager and click on **Test**. The system then checks that the connection is faultless. If the F-address is unknown, see point 5.
4. Select **Edit**. The **Edit connection** menu opens.
5. Select **Read F-address for the Ethernet connection**. You will be prompted to enter the **FS password** (default value: pssu) [2][3]. The F-address for the Ethernet connection is now read from the device.
6. The displayed F-address [4] is used temporarily to establish a connection to the device [5].

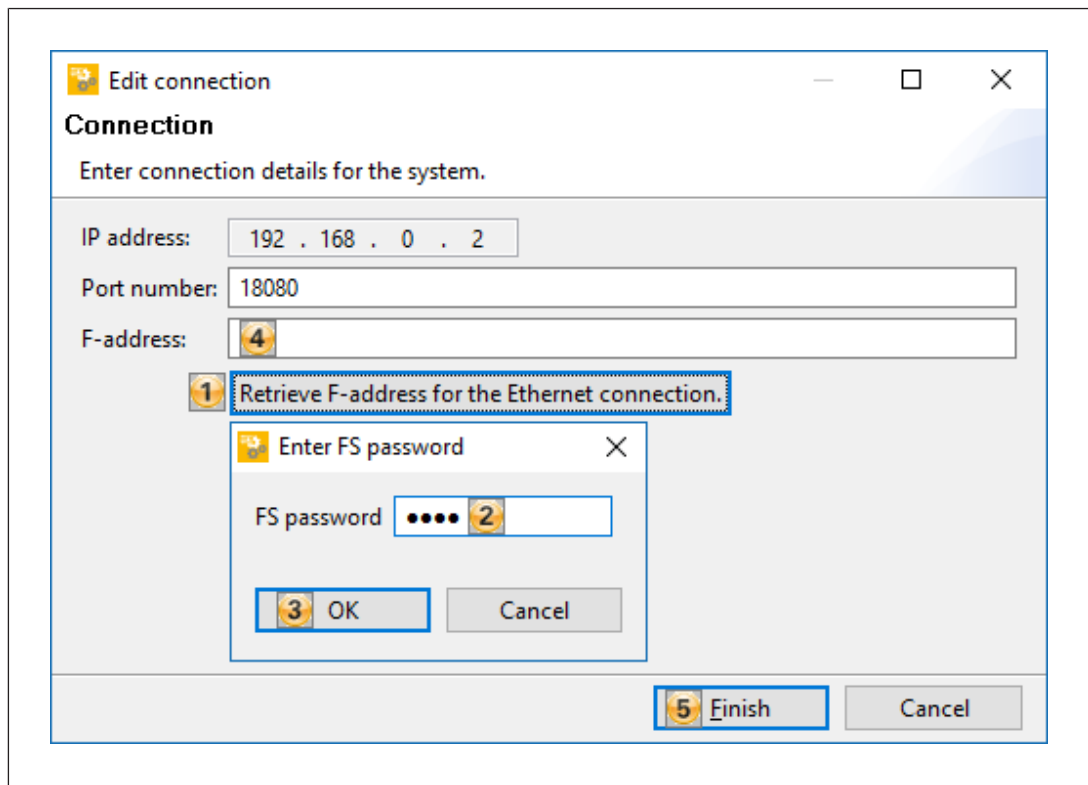

Fig.: PASconfig connection, read F-address for the Ethernet connection

Now you can perform two functions independently of each other and in any sequence:

- ▶ Load the current I/O configuration on to the device
- ▶ Load the current F-address (the one just read) on to the device via **System** -> **Enter F-address**.

► Support

Technical support is available from Pilz round the clock.

Americas

Brazil

+55 11 97569-2804

Canada

+1 888 315 7459

Mexico

+52 55 5572 1300

USA (toll-free)

+1 877-PILZUSA (745-9872)

Asia

China

+86 21 60880878-216

Japan

+81 45 471-2281

South Korea

+82 31 778 3300

Australia and Oceania

Australia

+61 3 95600621

New Zealand

+64 9 6345350

Europe

Austria

+43 1 7986263-0

Belgium, Luxembourg

+32 9 3217570

France

+33 3 88104003

Germany

+49 711 3409-444

Ireland

+353 21 4804983

Italy, Malta

+39 0362 1826711

Scandinavia

+45 74436332

Spain

+34 938497433

Switzerland

+41 62 88979-32

The Netherlands

+31 347 320477

Turkey

+90 216 5775552

United Kingdom

+44 1536 462203

You can reach our international hotline on:

+49 711 3409-222

support@pilz.com

Pilz develops environmentally-friendly products using ecological materials and energy-saving technologies. Offices and production facilities are ecologically designed, environmentally-aware and energy-saving. So Pilz offers sustainability, plus the security of using energy-efficient products and environmentally-friendly solutions.



We are represented internationally. Please refer to our homepage www.pilz.com for further details or contact our headquarters.

Headquarters: Pilz GmbH & Co. KG, Felix-Wankel-Straße 2, 73760 Ostfildern, Germany
Telephone: +49 711 3409-0, Telefax: +49 711 3409-133, E-Mail: info@pilz.com, Internet: www.pilz.com

PILZ
THE SPIRIT OF SAFETY

1005181-EN-02, 2022-12 Printed in Germany
© Pilz GmbH & Co. KG, 2019

CECE®, CHRE®, CMSE®, InduraNET p®, Leansafe®, Master of Safety®, Master of Security®, PAS4000®, PAScale®, PASconfig®, Pilz®, PTT®, PLID®, PMCPirimo®, PMCPiritego®, PMCTendo®, PMD®, PMJ®, PNOZ®, PRBM®, PRCM®, PRIMO®, PRM®, PSEN®, PSENi®, PSS®, PVS®, SafetyBUS p®, SafetyEYE®, SafetyNET p®, THE SPIRIT OF SAFETY® are registered and protected trademarks of Pilz GmbH & Co. KG in some countries. We would point out that product features may vary from the details stated in this document, depending on the status at the time of publication and the scope of the equipment. We accept no responsibility for the validity, accuracy and entirety of the text and graphics presented in this information. Please contact our Technical Support if you have any questions.