



▶ PNOZ s3

PILZ
THE SPIRIT OF SAFETY

Operating Manual-21395-EN-20
- Safety relays



This document is a translation of the original document.

Where unavoidable, for reasons of readability, the masculine form has been selected when formulating this document. We do assure you that all persons are regarded without discrimination and on an equal basis.

All rights to this documentation are reserved by Pilz GmbH & Co. KG. Copies may be made for the user's internal purposes. Suggestions and comments for improving this documentation will be gratefully received.

CECE®, CHRE®, CMSE®, INDUSTRIAL PI®, Leansafe®, MYZEL®, PAS4000®, PAS-cal®, PASconfig®, Pilz®, PIT®, PMCprimo®, PMCprotego®, PM Ctendo®, PMD®, PMI®, PNOZ®, Primo®, PSEN®, PSS®, PVIS®, SafetyBUS p®, SafetyEYE®, SafetyNET p®, THE SPIRIT OF SAFETY® are registered and protected trademarks of Pilz GmbH & Co. KG in some countries.



SD means Secure Digital

Introduction	5
Validity of documentation	5
Using the documentation	5
Definition of symbols	5
Safety	6
Intended use	6
Safety regulations	6
Safety assessment	6
Use of qualified personnel	7
Warranty and liability	7
Disposal	7
For your safety	7
Unit features	8
Safety features	8
Block diagram/terminal configuration	9
Function description	9
Timing diagram	10
Installation	11
Wiring	11
Preparing for operation	12
Operating modes	12
Set operating modes	12
Connection	13
Application examples	15
Operation	17
Status indicators	18
Error indicators	18
Faults - malfunctions	20
Dimensions in mm	20
Technical Details	20
Safety characteristic data	25
Classification according to ZVEI, CB24I	26
Supplementary data	27
Service life graph	27

Operating height in accordance with EN 60664-1	29
Remove plug-in terminals	30
Order reference	30
Product	30
Accessories	30
EU/EC declaration of conformity	31
UKCA-Declaration of Conformity	31

Introduction

Validity of documentation

This documentation is valid for the product PNOZ s3. It is valid until new documentation is published.

This operating manual explains the function and operation, describes the installation and provides guidelines on how to connect the product.

Using the documentation

This document is intended for instruction. Only install and commission the product if you have read and understood this document. The document should be retained for future reference.

Definition of symbols

Information that is particularly important is identified as follows:



DANGER!

This warning must be heeded! It warns of a hazardous situation that poses an immediate threat of serious injury and death and indicates preventive measures that can be taken.



WARNING!

This warning must be heeded! It warns of a hazardous situation that could lead to serious injury and death and indicates preventive measures that can be taken.



CAUTION!

This refers to a hazard that can lead to a less serious or minor injury plus material damage, and also provides information on preventive measures that can be taken.



NOTICE

This describes a situation in which the product or devices could be damaged and also provides information on preventive measures that can be taken. It also highlights areas within the text that are of particular importance.

**INFORMATION**

This gives advice on applications and provides information on special features.

Safety**Intended use**

The safety relay provides a safety-related interruption of a safety circuit.

The safety relay meets the requirements of EN 60947-5-1 and EN 60204-1 and may be used in applications with:

- ▶ E-STOP pushbuttons
- ▶ Safety gates
- ▶ Light grids and safety switches with detection of shorts across contacts

Improper use

The following is deemed improper use in particular:

- ▶ Any component, technical or electrical modification to the product,
- ▶ Use of the product outside the areas described in this operating manual,
- ▶ Use of the product outside the technical details (see chapter entitled [Technical Details](#) [ 20]).

**NOTICE****EMC-compliant electrical installation**

The product is designed for use in an industrial environment. The product may cause interference if installed in other environments. If installed in other environments, measures should be taken to comply with the applicable standards and directives for the respective installation site with regard to interference.

Safety regulations**Safety assessment**

Before using a unit, a risk assessment is required in accordance with the Machinery Regulation.

Connecting additional units may result in further risks. Take the necessary measures to protect against corruption.

The product as an individual component fulfils the functional safety requirements in accordance with EN ISO 13849 and EN IEC 62061. However, this does not guarantee the functional safety of the overall plant/machine. To achieve the relevant safety level of the overall plant/machine's required safety functions, each safety function needs to be considered separately.

Use of qualified personnel

Product installation, assembly, programming, commissioning, operation, decommissioning and maintenance may only be carried out by competent persons.

A competent person is a qualified and knowledgeable person who, because of their training, experience and current professional activity, has the specialist knowledge required.

In order to inspect, assess and handle products, devices, systems, plant and machinery, this person must be familiar with the state of the art and the applicable national, European and international laws, regulations, directives and standards.

It is the company's responsibility only to employ personnel who

- ▶ Are familiar with the basic regulations concerning health and safety / accident prevention,
- ▶ Have read and understood the section on "Safety" in this description and
- ▶ Have a good knowledge of the generic and specialist standards applicable to the specific application.

Warranty and liability

All claims to warranty and liability will be rendered invalid if

- ▶ The product was used contrary to the purpose for which it is intended,
- ▶ Damage can be attributed to not having followed the guidelines in the manual,
- ▶ Operating personnel are not suitably qualified,
- ▶ Any type of modification has been made (e.g. exchanging components on the PCB boards, soldering work etc.).

Disposal

- ▶ In safety-related applications, please comply with the mission time T_M stated in the safety-related characteristic data.
- ▶ When decommissioning, please comply with local regulations regarding the disposal of electronic devices (e.g. Electrical and Electronic Equipment Act).

For your safety

The unit meets all the necessary conditions for safe operation. However, please note the following:

- ▶ Note for overvoltage category III: If voltages higher than low voltage (>50 VAC or >120 VDC) are present on the unit, connected control elements and sensors must have a rated insulation voltage of at least 250 V.

Unit features

- ▶ Positive-guided relay outputs:
 - 2 safety contacts (N/O), instantaneous
- ▶ 1 semiconductor output
- ▶ Connection options for:
 - E-STOP pushbuttons
 - Safety gate limit switches
 - Start buttons
 - Light grids and safety switches with detection of shorts across contacts
- ▶ A connector can be used to connect 1 PNOZsigma contact expansion module
- ▶ Operating modes can be set via rotary switch
- ▶ LED indicator for:
 - Supply voltage
 - Input status, channel 1
 - Input status, channel 2
 - Switch status channel 1/2
 - Start circuit
 - Error
- ▶ Plug-in connection terminals (either spring-loaded terminal or screw terminal)
- ▶ See order reference for unit types

Safety features

The safety relay meets the following safety requirements:

- ▶ The circuit is redundant with built-in self-monitoring.
- ▶ The safety function remains effective in the case of a component failure.
- ▶ The correct opening and closing of the safety function relays is tested automatically in each on-off cycle.

Block diagram/terminal configuration

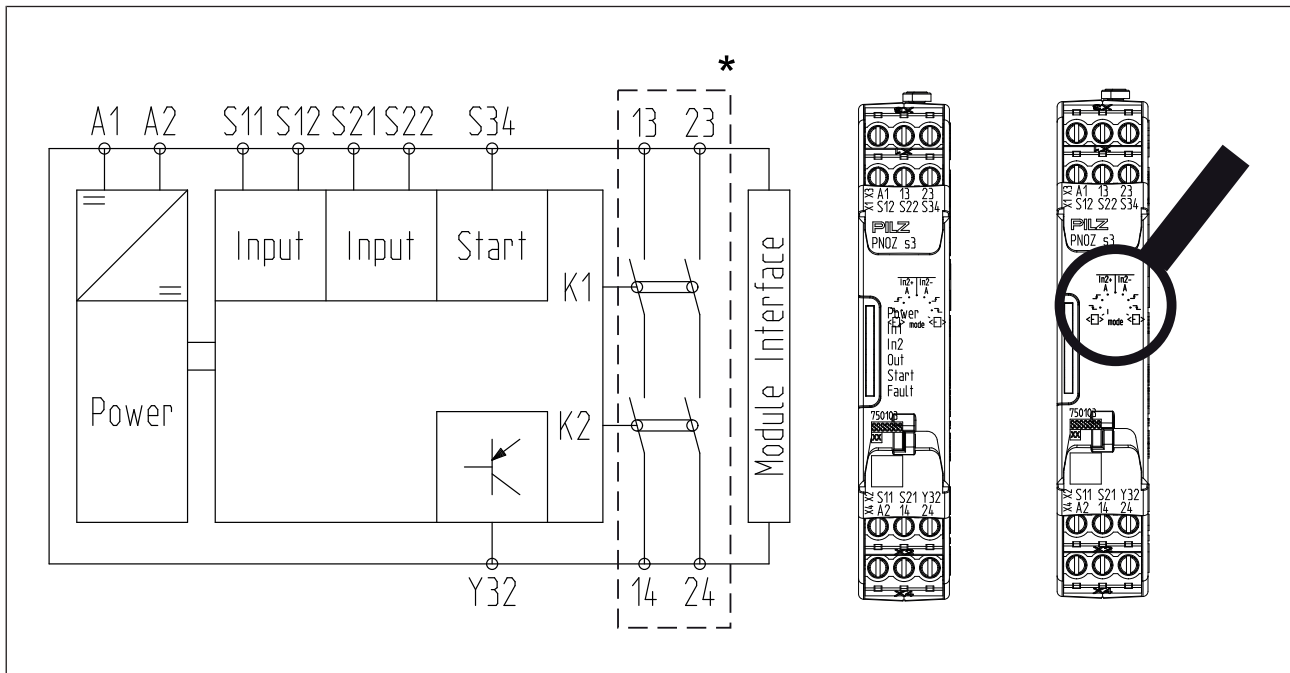



Fig.: Centre: Front view with cover, right: Front view without cover

*Insulation between the non-marked area and the relay contacts: Basic insulation (over-voltage category III), Protective separation (overvoltage category II)

Function description

- ▶ $\overline{\text{In2+}}$ Single-channel operation: no redundancy in the input circuit, earth faults in the start circuit and input circuit are detected.
- ▶ Dual-channel operation without detection of shorts across contacts: Redundant input circuit, detects PNOZ s3
 - earth faults in the start and input circuit,
 - short circuits in the input circuit and, with a monitored start, in the start circuit too.
- ▶ $\overline{\text{In2-}}$ Dual-channel operation with detection of shorts across contacts: Redundant input circuit, detects PNOZ s3
 - earth faults in the start and input circuit,
 - Short circuits in the input circuit and, with a monitored start, in the start circuit too,
 - Shorts across contacts in the input circuit.
- ▶ **A** Automatic start: Unit is active once the input circuit has been closed.
- ▶ Manual start Unit is active once the input circuit and the start circuit are closed.
- ▶ $\overline{\text{In2-}}$ Monitored start with falling edge: Unit is active once
 - the input circuit is closed and then the start circuit is closed and opened again.
 - the start circuit is closed and then opened again once the input circuit is closed.
- ▶ $\overline{\text{In2-}}$ Monitored start with rising edge: Unit is active once the input circuit is closed and once the start circuit is closed after the waiting period has elapsed (see technical details).

- ▶  Start with start-up test: The unit checks whether safety gates that are closed are opened and then closed again when supply voltage is applied.
- ▶ Increase in the number of available instantaneous safety contacts by connecting contact expander modules or external contactors/relays;
A connector can be used to connect 1 PNOZsigma contact expansion module.



NOTICE

The device does not recognise short circuits or shorts across contacts in the start/feedback loop. Take suitable measures, such as fault exclusion through protected or separate installation.

Timing diagram

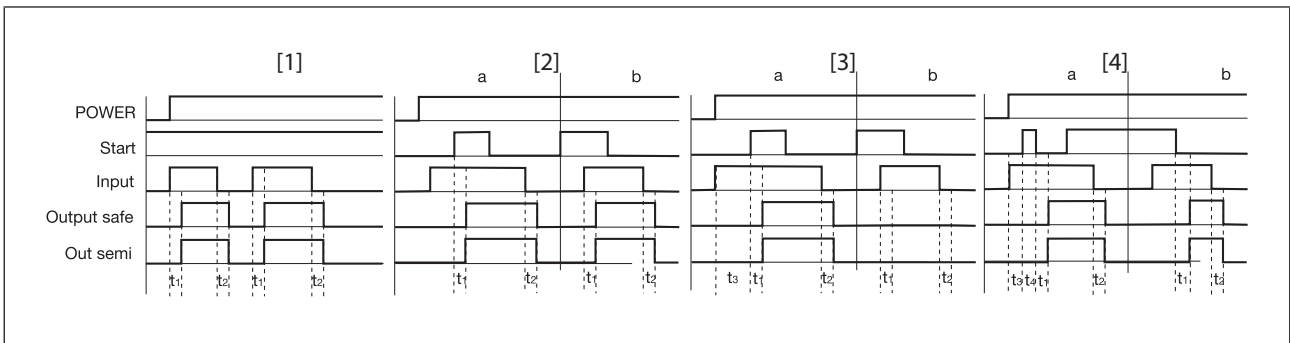

Legend

- ▶ POWER: Supply voltage
- ▶ Start: Start circuit
- ▶ Input: Input circuit
- ▶ Output safe: Safety contacts
- ▶ Out semi: Semiconductor output
- ▶ [1]: Automatic start
- ▶ [2]: Manual start
- ▶ [3]: Monitored start with rising edge
- ▶ [4]: Monitored start with falling edge
- ▶ a: Input circuit closes before start circuit
- ▶ b: Start circuit closes before input circuit
- ▶ t₁: Switch-on delay
- ▶ t₂: Delay-on de-energisation
- ▶ t₃: Waiting period with a monitored start
- ▶ t₄: Min. start pulse duration with a monitored start

Installation



NOTICE

Protection against manipulation

Protect the product from unauthorised access.

Install base unit without contact expansion module:

- ▶ Ensure that the plug terminator is inserted at the side of the unit.

Connect base unit and PNOZsigma contact expansion module:

- ▶ Remove the plug terminator at the side of the base unit and at the contact expansion module.
- ▶ Connect the base unit and the contact expansion module using the connector supplied, before mounting the units to the DIN rail.

Control cabinet installation

- ▶ Install the safety relay in a control cabinet with a protection type of at least IP54.
- ▶ Use the notch on the rear of the unit to attach it to a DIN rail (35 mm).
- ▶ When installed vertically: secure the device by using a fixing element (e.g. retaining bracket or end angle).
- ▶ Push the device upwards or downwards before lifting it from the DIN rail.

Wiring

Please note:

- ▶ Information given in the "[Technical details \[📖 20\]](#)" must be followed.
- ▶ Outputs 13-14 and 23-24 are safety contacts, the semiconductor output Y32 is an auxiliary output (e.g. for display).
- ▶ Semiconductor output Y32 should **not** be used for safety circuits!
- ▶ To prevent contact welding, a fuse should be connected before the output contacts (see [Technical details \[📖 20\]](#)).
- ▶ Calculation of the max. cable length l_{\max} in the input circuit:

$$l_{\max} = \frac{R_{l_{\max}}}{R_l / \text{km}}$$

$R_{l_{\max}}$ = max. overall cable resistance (see [Technical details \[📖 20\]](#))

R_l / km = cable resistance/km

- ▶ Use copper wiring with a temperature stability of 75 °C.
- ▶ To prevent EMC interferences (particularly common-mode interferences) the measures described in EN 60204-1 must be executed. This includes the separate routing of cables of the control circuits (input, start and feedback loop) from other cables for energy transmission or the shielding of cables, for example.
- ▶ Adequate protection circuit must be provided on all output contacts with capacitive and inductive loads.
- ▶ When connecting magnetically operated, reed proximity switches, ensure that the max. peak inrush current (on the input circuit) does not overload the proximity switch.

- ▶ The power supply must comply with the regulations for extra low voltages with protective electrical separation (SELV, PELV) in accordance with VDE 0100, Part 410.

Preparing for operation

Operating modes

The operating mode and delay time are set via the rotary switches on the unit. You can do this by opening the cover on the front of the unit.



NOTICE

Always carry out the following steps before the unit is set for the first time and with each change of the rotary switch.

Check that the rotary switch locks into position correctly:

- ▶ Turn the rotary switch as far as it will go to the left and right.
- ▶ Check the click sound and "click feel" in each individual position.

When you bring the rotary switch to the desired position, make sure that the rotary switch locks in position (click feel). The actual lock-in position may vary slightly from the labelling, as there are minor manufacturing tolerances.

Protection against manipulation

Attach the rotary switch using an adhesive seal (see [order reference \[📖 30\]](#)).

If the adhesive seal is broken, check the setting.

Set operating modes

- ▶ Switch off supply voltage.
- ▶ Select operating mode via the operating mode selector switch "mode".
- ▶ If the operating mode selector switch "mode" is in its start position (vertical position), an error message will appear.

Operating mode selector switch "mode"	Automatic or manual start	Monitored start rising edge	Monitored start falling edge	Automatic start with start-up test
Without detection of shorts across contacts				
With detection of shorts across contacts				



NOTICE

Do not adjust the rotary switch during operation, otherwise an error message will appear, the safety contacts will open and the unit will not be ready for operation until the supply voltage has been switched off and then on again.

Connection

Supply voltage	AC	DC
	/	

Input circuit	Single-channel	Dual-channel
Emergency stop without detection of shorts across contacts		
Emergency stop with detection of shorts across contacts	/	
Safety gate without detection of shorts across contacts		
Safety gate with detection of shorts across contacts	/	

Input circuit	Single-channel	Dual-channel
Light beam device or safety switch, detection of shorts across contacts via ESPE		



NOTICE

With single-channel wiring, the safety level of your plant/machine may be lower than the safety level of the unit (see [Safety characteristic data \[25\]](#)). To achieve the stated safety level, appropriate measures must be taken on single-channel applications to exclude faults in the input circuit. Examples of such measures are: protected cable routing and positive-opening contacts in the E-STOP pushbutton.



NOTICE

When operated with a light curtain or sensor

- It must not be possible to switch off the supply voltage for the PNOZ-sigma separately from the supply voltage for the light curtain or safety switch. Separate circuit protection or overload protection is permitted.
- The operating mode selector switch must be set to "Without detection of shorts across contacts", as shorts across contacts are detected by the ESPE.

Start circuit/feedback loop	without feedback loop monitoring	with feedback loop monitoring
Automatic start		
Monitored, manual start/restart		



NOTICE

In the event of an automatic start or manual start with bridged start contact (fault):

The unit starts up automatically when the safeguard is reset, e.g. when the E-STOP pushbutton is released. Use external circuit measures to prevent an unexpected restart.

Semiconductor output

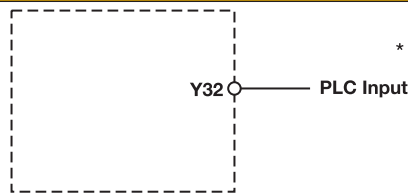

*Connect together the 0V connections on all the external power supplies

Application examples

Emergency stop

- ▶ Dual-channel
- ▶ with detection of shorts across contacts
- ▶ Monitored start
- ▶ falling edge with feedback loop monitoring

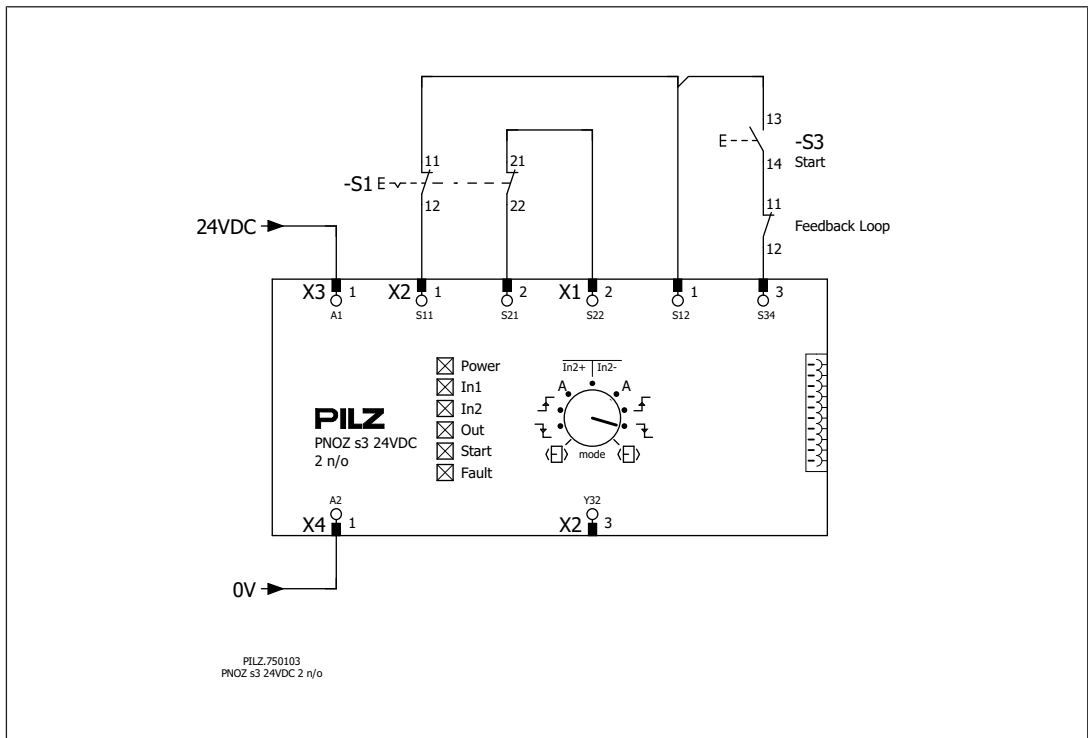

Safety gate

- ▶ Dual-channel
- ▶ with detection of shorts across contacts
- ▶ Monitored start
- ▶ falling edge with feedback loop monitoring

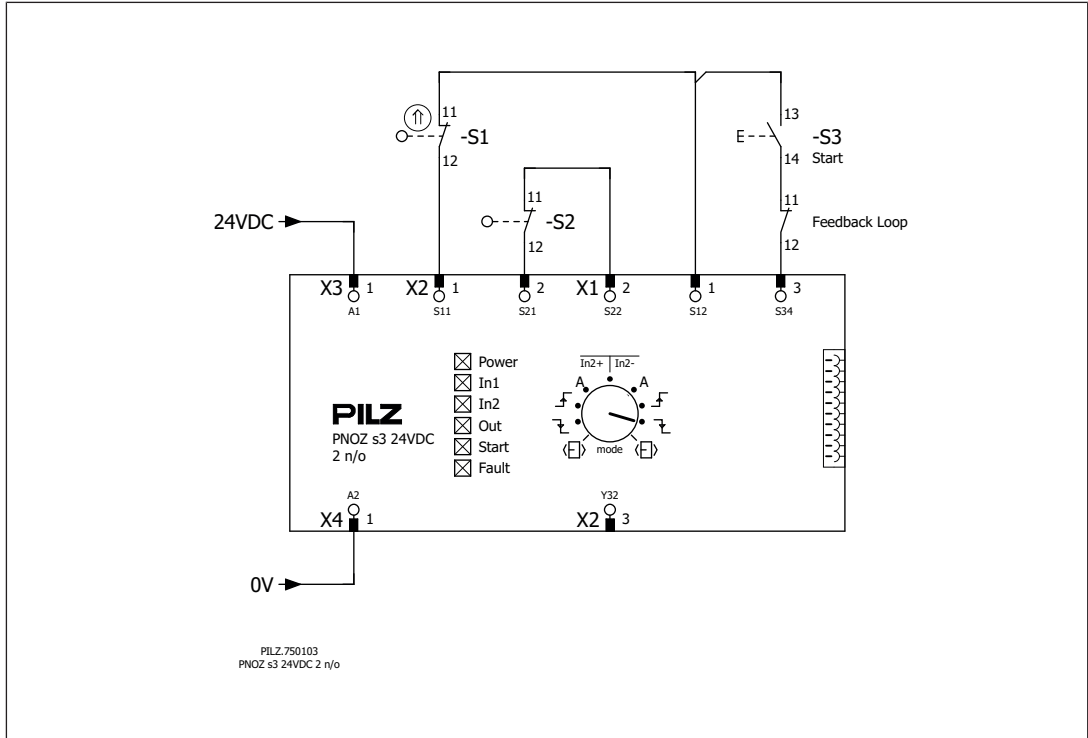

OSSD signals

- ▶ Dual-channel
- ▶ without detection of shorts across contacts of PNOZ - detection of shorts across contacts by sensor technology
- ▶ Automatic start
- ▶ with feedback loop monitoring

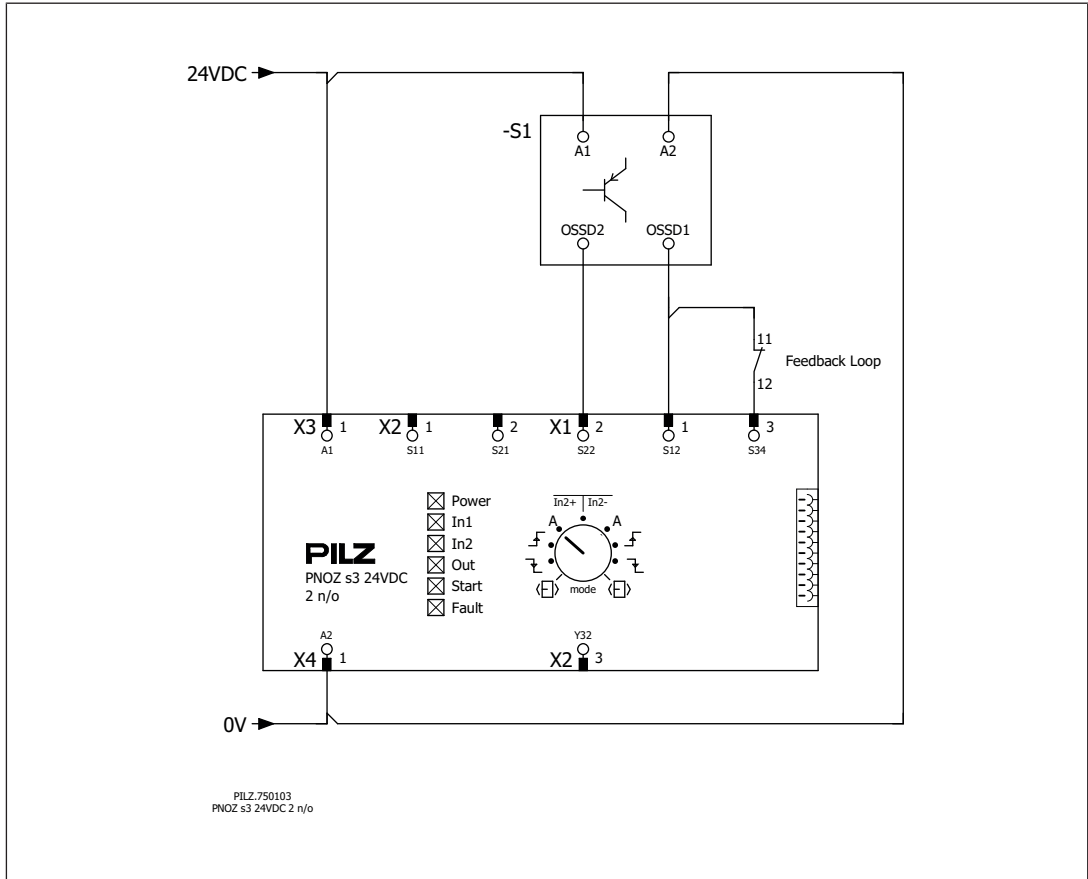

Operation

When the relay outputs are switched on, the mechanical contact on the relay cannot be tested automatically. Depending on the operational environment, measures to detect the non-opening of switching elements may be required under some circumstances.

When the product is used in accordance with the European Machinery Regulation, a check must be carried out to ensure that the safety contacts on the relay outputs open correctly. Open the safety contacts (switch off output) and start the device again, so that the internal diagnostics can check that the safety contacts open correctly



- ▶ For SIL 3/PL e, at least 1x per month
- ▶ For SIL 2/PL d, at least 1x per year

**NOTICE**

The safety functions should be checked after initial commissioning and each time the plant/machine is changed. The safety functions may only be checked by qualified personnel.

The unit is ready for operation when the Power LED is permanently lit.





LEDs indicate the status and errors during operation:

-  LED on
-  LED flashes
-  LED off

**INFORMATION**

Status indicators and error indicators may occur independently. In the case of an error display, the "Fault" LED will light or flash (exception: "Supply voltage too low"). An LED that is also flashing indicates the potential cause of the error. An LED that is lit and is static indicates a normal operating status. Several status indicators and error indicators may occur simultaneously.

Status indicators

-  **POWER**
Supply voltage is present.
-  **IN1**
Input circuit at S12 is closed.
-  **IN2**
Input circuit at S22 is closed.
-  **OUT**
Safety contacts are closed and semiconductor output Y32 carries a high signal.
-  **START**
24 VDC is present at S34.

Error indicators

-  **All LEDs off**
Diagnostics: Short across contacts/earth fault; unit switched off
 - ▶ Remedy: Rectify short across contacts/earth fault, switch off supply voltage for 1 min.



FAULT

Diagnostics: Plug terminator not connected

▶ Remedy: Insert plug terminator, switch supply voltage off and then on again.



FAULT

Diagnostics: Internal error, unit defective

▶ Remedy: Switch supply voltage off and then on again, change unit if necessary.



POWER

Diagnostics: Supply voltage too low

▶ Remedy: Check supply voltage and increase if necessary.



IN1, IN2 alternately



FAULT

Diagnostics: Connection error (possibly: cable resistance in the input circuit is too high) or short detected between S12 and S22

▶ Remedy: Rectify connection error or short across contacts, switch supply voltage off and then on again.



IN1



FAULT

Diagnostics: Power-up blocked due to short-term interruption at S12; channels in the input circuit not opened simultaneously.

▶ Remedy: Open S11-S12 and S21-S22 simultaneously and then close again.



IN2



FAULT

Diagnostics: Power-up blocked due to short-term interruption at S22; channels in the input circuit not opened simultaneously.

▶ Remedy: Open S11-S12 and S21-S22 simultaneously and then close again.



IN1, IN2 simultaneously



FAULT

Diagnostics: Power-up blocked due to short-term interruption at S12 and S22; channels in the input circuit not opened simultaneously.

▶ Remedy: Open S11-S12 and S21-S22 simultaneously and then close again.



START



FAULT

Diagnostics: Position of rotary switch is not permitted or rotary switch was adjusted during operation.

▶ Remedy: Switch supply voltage off and then on again.



POWER, IN1, IN2, OUT, START, FAULT

Diagnostics: The operating mode selector switch "mode" is in its start position (vertical position)

- ▶ Remedy: Switch off the supply voltage and set the required operating mode on operating mode selector switch "mode".

Faults - malfunctions

- ▶ Contact malfunctions: If the contacts have welded, reactivation will not be possible after the input circuit has opened.

Dimensions in mm

*with spring-loaded terminals

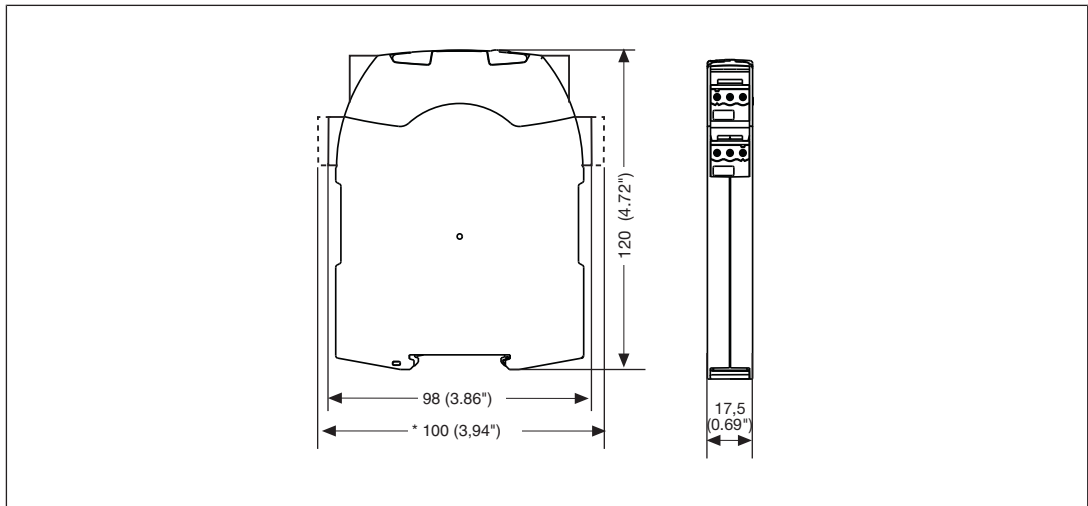

Technical Details

Where standards are undated, the 2022-09 valid editions apply.

General	750103	751103
Certifications	CCC, CE, EAC, KOSHA, TÜV, UKCA, cULus Listed	CCC, CE, EAC, KOSHA, TÜV, UKCA, cULus Listed
Electrical data	750103	751103
Supply voltage		
Voltage	24 V	24 V
Kind	DC	DC
Voltage tolerance	-15 %/+10 %	-15 %/+10 %
Output of external power supply (DC)	2,5 W	2,5 W
Residual ripple DC	20 %	20 %
Duty cycle	100 %	100 %

Electrical data	750103	751103
Max. inrush current impulse		
Current pulse, A1	0,5 A	0,5 A
Pulse duration, A1	5 ms	5 ms
Inputs	750103	751103
Quantity	2	2
Voltage at		
Input circuit DC	24 V	24 V
Start circuit DC	24 V	24 V
Feedback loop DC	24 V	24 V
Current at		
Input circuit DC	50 mA	50 mA
Start circuit DC	50 mA	50 mA
Feedback loop DC	50 mA	50 mA
Max. inrush current impulse		
Current pulse, input circuit	0,2 A	0,2 A
Pulse duration, input circuit	100 ms	100 ms
Current pulse, feedback loop	0,2 A	0,2 A
Pulse duration, feedback loop	15 ms	15 ms
Current pulse, start circuit	0,2 A	0,2 A
Pulse duration, start circuit	15 ms	15 ms
Min. input resistance at power-on	110 Ohm	110 Ohm
Max. overall cable resistance RI-max		
Single-channel at UB DC	30 Ohm	30 Ohm
Dual-channel without detection of shorts across contacts at UB DC	60 Ohm	60 Ohm
Dual-channel with detection of shorts across contacts at UB DC	30 Ohm	30 Ohm
Semiconductor outputs	750103	751103
Quantity	1	1
Voltage	24 V	24 V
Current	20 mA	20 mA
Residual current at "0" signal	0,1 mA	0,1 mA
Max. internal voltage drop	5 V	5 V
Conditional rated short circuit current	100 A	100 A
Lowest operating current	0 mA	0 mA
Utilisation category in accordance with EN 60947-1	DC-12	DC-12
Relay outputs	750103	751103
Number of output contacts		
Safety contacts (N/O), instantaneous	2	2
Max. short circuit current IK	1 kA	1 kA

Relay outputs	750103	751103
Utilisation category		
in accordance with the standard	EN 60947-4-1	EN 60947-4-1
Utilisation category of safety contacts		
AC1 at	240 V	240 V
Min. current	0,003 A	0,003 A
Max. current	6 A	6 A
Min. power	0,04 VA	0,04 VA
Max. power	1.500 VA	1.500 VA
DC1 at	24 V	24 V
Min. current	0,003 A	0,003 A
Max. current	6 A	6 A
Min. power	0,04 W	0,04 W
Max. power	150 W	150 W
Utilisation category		
in accordance with the standard	EN 60947-5-1	EN 60947-5-1
Utilisation category of safety contacts		
AC15 at	230 V	230 V
Max. current	5 A	5 A
DC13 (6 cycles/min) at	24 V	24 V
Max. current	5 A	5 A
Utilisation category in accordance with UL		
Voltage with current	240 V AC G.U. (same polarity) 6 A	240 V AC G.U. (same polarity) 6 A
Voltage with current	24 V DC G. U. 6 A	24 V DC G. U. 6 A
External contact fuse protection, safety contacts		
in accordance with the standard	EN 60947-5-1	EN 60947-5-1
Max. melting integral	260 A²s	260 A²s
Blow-out fuse, quick	10 A	10 A
Blow-out fuse, slow	6 A	6 A
Blow-out fuse, gG	10 A	10 A
Circuit breaker 24V AC/DC, characteristic B/C	6 A	6 A
Conventional thermal current	6 A	6 A
Contact material	AgCuNi + 0,2 µm Au	AgCuNi + 0,2 µm Au

Times	750103	751103
Switch-on delay		
with automatic start typ.	170 ms	170 ms
with automatic start max.	300 ms	300 ms
with automatic start after power on typ.	540 ms	540 ms
with automatic start after power on max.	780 ms	780 ms
with manual start typ.	40 ms	40 ms
with manual start max.	300 ms	300 ms
with monitored start with rising edge typ.	35 ms	35 ms
with monitored start with rising edge max.	50 ms	50 ms
with monitored start with falling edge typ.	55 ms	55 ms
with monitored start with falling edge max.	70 ms	70 ms
Delay-on de-energisation		
with E-STOP typ.	10 ms	10 ms
with E-STOP max.	20 ms	20 ms
with power failure typ.	40 ms	40 ms
with power failure max.	60 ms	60 ms
Recovery time at max. switching frequency 1/s		
after E-STOP	100 ms	100 ms
after power failure	1 s	1 s
Waiting period with a monitored start		
with rising edge	120 ms	120 ms
with falling edge	250 ms	250 ms
Min. start pulse duration with a monitored start		
with falling edge	100 ms	100 ms
with rising edge	30 ms	30 ms
Supply interruption before de-energisation		
	20 ms	20 ms
Simultaneity, channel 1 and 2 max.		
	∞	∞
Environmental data		
Climatic suitability		
	EN 60068-2-78	EN 60068-2-78
Ambient temperature		
Temperature range	-10 - 55 °C	-10 - 55 °C
Storage temperature		
Temperature range	-40 - 85 °C	-40 - 85 °C
Climatic suitability		
Humidity	93 % r. h. at 40 °C	93 % r. h. at 40 °C
Condensation during operation		
	Not permitted	Not permitted

Environmental data	750103	751103
EMC	EN 60947-5-1, EN 61000-6-2, EN 61000-6-4, EN 61326-3-1	EN 60947-5-1, EN 61000-6-2, EN 61000-6-4, EN 61326-3-1
Vibration		
in accordance with the standard	EN 60068-2-6	EN 60068-2-6
Frequency	10 - 55 Hz	10 - 55 Hz
Amplitude	0,35 mm	0,35 mm
Airgap creepage		
in accordance with the standard	EN 60947-1	EN 60947-1
Overvoltage category	III / II	III / II
Pollution degree	2	2
Rated insulation voltage	250 V	250 V
Rated impulse withstand voltage	4 kV	4 kV
Protection type		
Housing	IP40	IP40
Terminals	IP20	IP20
Mounting area (e.g. control cabinet)	IP54	IP54
Mechanical data	750103	751103
Mounting position	Any	Any
Mechanical life	10,000,000 cycles	10,000,000 cycles
Material		
Bottom	PC	PC
Front	PC	PC
Top	PC	PC
Connection type	Screw terminal	Spring-loaded terminal
Mounting type	plug-in	plug-in
Conductor cross section with screw terminals		
1 core flexible	0,25 - 2,5 mm ² , 24 - 12 AWG	–
2 core with the same cross section, flexible with crimp connectors, no plastic sleeve	0,25 - 1 mm ² , 24 - 16 AWG	–
2 core with the same cross section, flexible without crimp connectors or with TWIN crimp connectors	0,2 - 1,5 mm ² , 24 - 16 AWG	–
Torque setting with screw terminals	0,5 Nm	–
Stripping length with screw terminals	7 mm	–
Conductor cross section with spring-loaded terminals: Flexible with/without crimp connector	–	0,2 - 2,5 mm ² , 24 - 12 AWG
Spring-loaded terminals: Terminal points per connection	–	2
Stripping length with spring-loaded terminals	–	9 mm

Mechanical data	750103	751103
Dimensions		
Height	98 mm	100 mm
Width	17,5 mm	17,5 mm
Depth	120 mm	120 mm
Weight	140 g	140 g

Safety characteristic data



NOTICE

You must comply with the safety characteristic data in order to achieve the required safety level for your plant/machine.

Operating mode	EN ISO 13849-1: 2023	EN ISO 13849-1: 2023	EN IEC 62061 SIL CL/max.	EN IEC 62061 61508	EN/IEC 61511 61508	EN/IEC 61511 61508	EN ISO 13849-1: 2023
	PL	Category	SIL	PFH [1/h]	SIL	PFD	T _M [year]
	e	4	3	2,31E-09	3	2,03E-06	20

Safety contacts, instantaneous

Explanatory notes for the safety-related characteristic data:

- ▶ T_M is the maximum mission time in accordance with EN ISO 13849-1. The value also applies as the retest interval in accordance with EN IEC 61508-6 and EN IEC 61511 and as the proof test interval and mission time in accordance with EN IEC 62061.

All the units used within a safety function must be considered when calculating the safety characteristic data.



INFORMATION

A safety function's SIL/PL values are **not** identical to the SIL/PL values of the products used and may differ from these.

Classification according to ZVEI, CB24I

The following tables describe the classes and specific values of the product interface and the classes of interfaces compatible with it. The classification is described in the ZVEI position paper "Classification of Binary 24 V Interfaces - Functional Safety aspects covered by dynamic testing".

Input

Interfaces

Drain

Interface	Module
Class	C0

Source

Interface	Sensor
Class	C1, C2, C3

Drain parameters

Max. test pulse duration	2 ms
Min. input resistance	0,5 kOhm
Max. capacitive load	10 nF

Relay outputs

Interfaces

Source

Interface	Module
Class	A

Drain

Interface	Actuator
Class	A

Source parameters

Min. switching voltage	12 V
Max. switching voltage	250 V
Min. switching current	0,003 A
Max. switching current	6 A
Potential isolation	Yes

Supplementary data



CAUTION!

It is essential to consider the relay's service life graphs. The relay outputs' safety-related characteristic data is only valid if the values in the service life graphs are met.

The PFH value depends on the switch frequency and the load of the relay output. If the service life graphs are not accessible, the stated PFH value can be used irrespective of the switch frequency and the load, as the PFH value already considers the relay's B10d value as well as the failure rates of the other components.

Service life graph

The service life graphs indicate the number of cycles from which failures due to wear must be expected. The wear is mainly caused by the electrical load; the mechanical load is negligible.

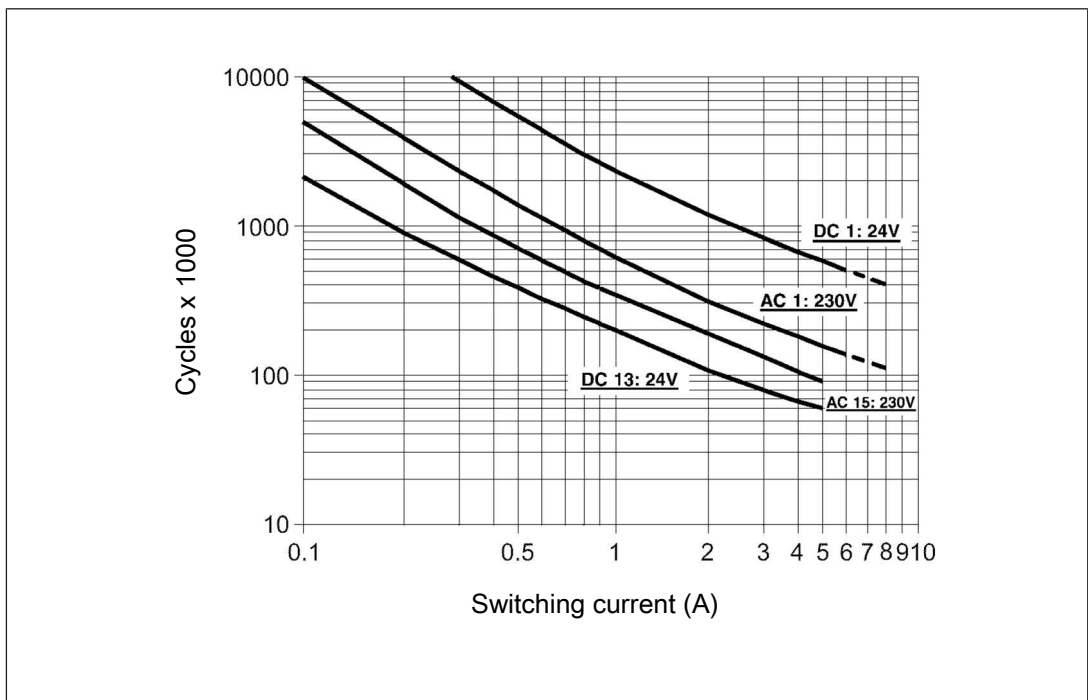

Fig.: Service life graphs at 24 V DC and 230 V AC

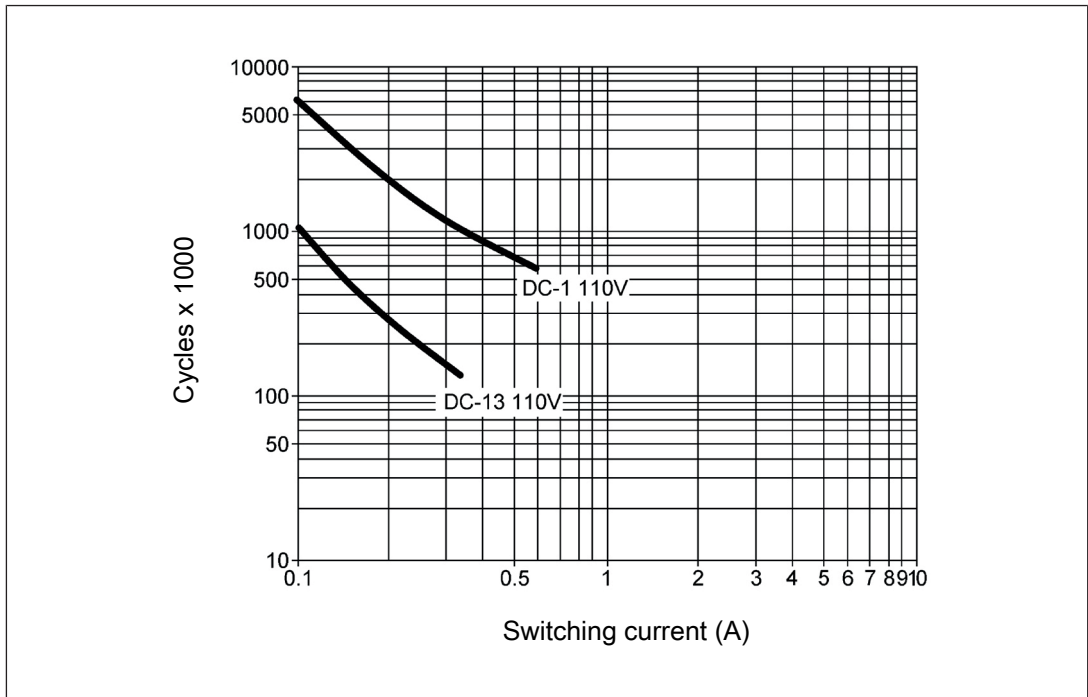

Fig.: Service life graphs at 110 V DC

Example

- ▶ Inductive load: 0.2 A
- ▶ Utilisation category: AC15
- ▶ Contact service life: 2 000 000 cycles

Provided the application to be implemented requires fewer than 2 000 000 cycles, the PFH value (see [Technical details \[📖 20\]](#)) can be used in the calculation.

To increase the service life, sufficient spark suppression must be provided on all output contacts. With capacitive loads, any power surges that occur must be noted. With DC contactors, use flywheel diodes for spark suppression.

Operating height in accordance with EN 60664-1

The values stated in the technical details apply to the use of the product in operating heights up to max. 2000 m above sea level. When used in greater heights, constraints have to be taken into account:

- ▶ Permitted maximum operating height 5000 m
- ▶ Reduction of rated insulation voltage and rated impulse withstand voltage for applications with safe separation:

Maximum operation height	Rated insulation voltage	Overvoltage category	Max. rated impulse withstand voltage
3000 m	150 V	II	2.5 kV
	100 V	III	2.5 kV
4000 m	150 V	II	2.5 kV
	100 V	III	2.5 kV
5000 m	100 V	II	1.5 kV
	24 V	III	0.8 kV

- ▶ Reduction of rated insulation voltage and rated impulse withstand voltage for applications with basic insulation:

Maximum operation height	Rated insulation voltage	Overvoltage category	Max. rated impulse withstand voltage
3000 m	250 V	II	2.5 kV
	150 V	III	2.5 kV
4000 m	250 V	II	2.5 kV
	150 V	III	2.5 kV
5000 m	150 V	II	1.5 kV
	100 V	III	1.5 kV

- ▶ From an operating height of 2000 m the max. permitted ambient temperature is reduced by 0.5 °C/100 m

Operating height	Permitted ambient temperature
3000 m	50 °C
4000 m	45 °C
5000 m	40 °C

Remove plug-in terminals

Procedure

► Insert a suitable screwdriver into the housing recess behind the terminal.

Do **not** remove the terminals by pulling the cables!

► Lever the terminal out.

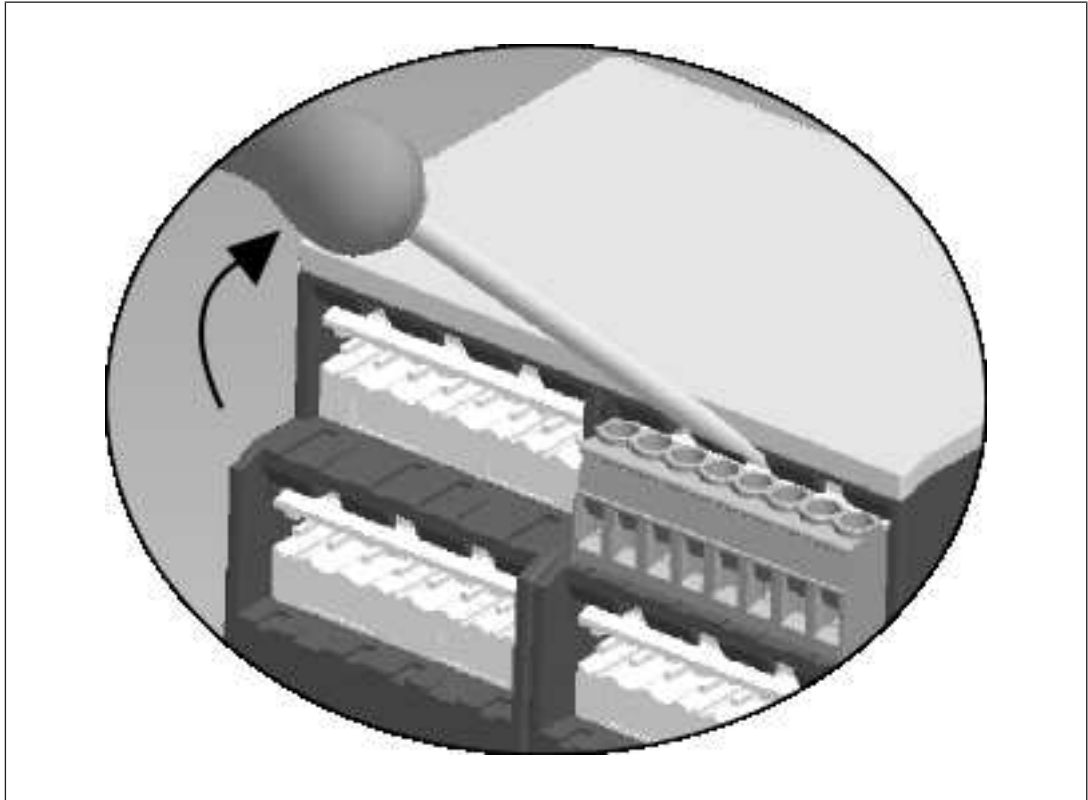

Order reference

Product

Product type	Features	Connection type	Product ID
PNOZ s3	24 VDC	Screw terminals	750103
PNOZ s3 C	24 VDC	Spring-loaded terminals	751103

Accessories

Product type	Features	Product ID
Adhesive seal for myPNOZ (20 pieces)	Adhesive seal for myPNOZ to protect rotary switch settings from manipulation	2A000200

EU/EC declaration of conformity

These products meet the requirements of the directive 2006/42/EC on machinery up to and including 19 January 2027, and the EU regulation 2023/1230 of the European Parliament and of the Council from 20 January 2027. The full EU and EC declaration of conformity is available to download at www.pilz.com/manuals.

Authorised representative: Pilz GmbH & Co. KG, Felix-Wankel-Str. 2, 73760 Ostfildern, Germany

UKCA-Declaration of Conformity

These products comply with following UK legislation: Supply of Machinery (Safety) Regulation 2008.

The complete UKCA Declaration of Conformity is available on the Internet at www.pilz.com/manuals.

Representative: Pilz Automation Technology, Pilz House, Little Colliers Field, Corby, Northamptonshire, NN18 8TJ United Kingdom, eMail: mail@pilz.co.uk

Support

Technical support is available from Pilz round the clock.

Americas

Brazil

+55 11 97569-2804

Canada

+1 888 315 7459

Mexico

+52 55 5572 1300

USA (toll-free)

+1 877-PILZUSA (745-9872)

Asia

China

+86 400-088-3566

Japan

+81 45 471-2281

South Korea

+82 31 778 3390

Australia and Oceania

Australia

+61 3 95600621

New Zealand

+64 9 6345350

Europe

Austria

+43 1 7986263-444

Belgium, Luxembourg

+32 9 3217570

France

+33 3 88104003

Germany

+49 711 3409-444

Ireland

+353 21 4804983

Italy, Malta

+39 0362 1826711

Scandinavia

+45 74436332

Spain

+34 938497433

Switzerland

+41 62 88979-32

The Netherlands

+31 347 320477

Türkiye

+90 216 5775552

United Kingdom

+44 1536 460866

You can reach our international hotline on:

+49 711 3409-222

support@pilz.com

Reporting security vulnerabilities or security incidents

If you would like to report a security vulnerability or a security incident in connection with a Pilz product, please contact our **Pilz Product Security Incident Response Team (PSIRT)**.

You can reach us at: www.pilz.com/psirt

Pilz develops environmentally-friendly products using ecological materials and energy-saving technologies. Offices and production facilities are ecologically designed, environmentally-aware and energy-saving. So Pilz offers sustainability, plus the security of using energy-efficient products and environmentally-friendly solutions.



www.pilz.com/facebook



www.pilz.com/linkedin



www.pilz.com/xing



www.pilz.com/youtube



21395-EN-20, 2026-05 Printed in Germany
© Pilz GmbH & Co. KG, 2024

CECE, CHRE, CMSE®, IndustrialPi®, Leansate®, MYZEL®, PAS4000®, PAScal®, PASconfig®, Pilz®, PII™, PMCprimo®, PMCprotego®, PMCTendo®, PMD®, PMI®, PNOZ®, Primo®, PSEN®, PSS®, PVS®, SafetyBUS p®, SafetyNET p®, THE SPIRIT OF SAFETY® are registered and protected trademarks of Pilz GmbH & Co. KG in some countries. We would point out that product features may vary from the details stated in this document, depending on the status at the time of publication and the scope of the equipment. We accept no responsibility for the validity, accuracy and entirety of the text and graphics presented in this information. Please contact our Technical Support if you have any questions.

We are represented internationally. Please refer to our homepage www.pilz.com for further details or contact our headquarters.

Headquarters: Pilz GmbH & Co. KG, Felix-Wankel-Straße 2, 73760 Ostfildern, Germany
Telephone: +49 711 3409-0, E-Mail: info@pilz.com, Internet: www.pilz.com

