



▶ PNOZ X2.8P

PILZ

THE SPIRIT OF SAFETY

Operating Manual-1004082-EN-25

- Safety relays



This document is the original document.

Where unavoidable, for reasons of readability, the masculine form has been selected when formulating this document. We do assure you that all persons are regarded without discrimination and on an equal basis.

All rights to this documentation are reserved by Pilz GmbH & Co. KG. Copies may be made for the user's internal purposes. Suggestions and comments for improving this documentation will be gratefully received.

CECE®, CHRE®, CMSE®, INDUSTRIAL PI®, Leansafe®, MYZEL®, PAS4000®, PAS-cal®, PASconfig®, Pilz®, PIT®, PMCprimo®, PMCprotego®, PMctendo®, PMD®, PMI®, PNOZ®, Primo®, PSEN®, PSS®, PVIS®, SafetyBUS p®, SafetyEYE®, SafetyNET p®, THE SPIRIT OF SAFETY® are registered and protected trademarks of Pilz GmbH & Co. KG in some countries.



SD means Secure Digital

Introduction	5
Validity of documentation	5
Using the documentation	5
Definition of symbols	5
Safety	6
Intended use	6
Safety regulations	6
Safety assessment	6
Use of qualified personnel	7
Warranty and liability	7
Disposal	7
For your safety	7
Unit features	8
Safety features	8
Block diagram/terminal configuration	9
Type: 24 VAC/DC	9
Type: 24 - 240 V AC/DC	9
Function Description	10
Operating modes	10
Timing diagram	11
Installation	11
Wiring	12
Preparing for operation	13
Operation	15
Status indicators	16
Faults – Interference	16
Dimensions in mm	16
Technical details, Product ID 777301, 777302	17
Technical details, Product ID 787301, 787302	22
Safety characteristic data	26
Supplementary data	28
Service life graph	28

Remove plug-in terminals	31
Order reference	32
EU/EC declaration of conformity	32
UKCA-Declaration of Conformity	32

Introduction

Validity of documentation

This documentation is valid for the product PNOZ X2.8P. It is valid until new documentation is published.

This operating manual explains the function and operation, describes the installation and provides guidelines on how to connect the product.

Using the documentation

This document is intended for instruction. Only install and commission the product if you have read and understood this document. The document should be retained for future reference.

Definition of symbols

Information that is particularly important is identified as follows:



DANGER!

This warning must be heeded! It warns of a hazardous situation that poses an immediate threat of serious injury and death and indicates preventive measures that can be taken.



WARNING!

This warning must be heeded! It warns of a hazardous situation that could lead to serious injury and death and indicates preventive measures that can be taken.



CAUTION!

This refers to a hazard that can lead to a less serious or minor injury plus material damage, and also provides information on preventive measures that can be taken.



NOTICE

This describes a situation in which the product or devices could be damaged and also provides information on preventive measures that can be taken. It also highlights areas within the text that are of particular importance.



INFORMATION

This gives advice on applications and provides information on special features.

Safety

Intended use

The safety relay PNOZ X2.8P provides a safety-related interruption of a safety circuit.

The safety relay meets the requirements of EN 60947-5-1 and EN 60204-1 and may be used in applications with:

- ▶ E-STOP pushbuttons
- ▶ Safety gates
- ▶ Light grids and safety switches with detection of shorts across contacts

Improper use

The following is deemed improper use in particular:

- ▶ Any component, technical or electrical modification to the product,
- ▶ Use of the product outside the areas described in this operating manual,
- ▶ Use of the product outside the technical details (see chapter entitled [Technical Details](#) [ 17]).



NOTICE

EMC-compliant electrical installation

The product is designed for use in an industrial environment. The product may cause interference if installed in other environments. If installed in other environments, measures should be taken to comply with the applicable standards and directives for the respective installation site with regard to interference.

Safety regulations

Safety assessment

Before using a unit, a risk assessment is required in accordance with the Machinery Regulation.

Connecting additional units may result in further risks. Take the necessary measures to protect against corruption.

The product as an individual component fulfils the functional safety requirements in accordance with EN ISO 13849 and EN IEC 62061. However, this does not guarantee the functional safety of the overall plant/machine. To achieve the relevant safety level of the overall plant/machine's required safety functions, each safety function needs to be considered separately.

Use of qualified personnel

The products may only be assembled, installed, programmed, commissioned, operated, de-commissioned and maintained by persons who are competent to do so.

A competent person is a qualified and knowledgeable person who, because of their training, experience and current professional activity, has the specialist knowledge required. In order to inspect, assess and handle products, devices, systems, plant and machinery, this person must be familiar with the state of the art and the applicable national, European and international laws, directives and standards.

It is the company's responsibility only to employ personnel who

- ▶ Are familiar with the basic regulations concerning health and safety / accident prevention,
- ▶ Have read and understood the information provided in the section entitled Safety
- ▶ Have a good knowledge of the generic and specialist standards applicable to the specific application.

Warranty and liability

All claims to warranty and liability will be rendered invalid if

- ▶ The product was used contrary to the purpose for which it is intended,
- ▶ Damage can be attributed to not having followed the guidelines in the manual,
- ▶ Operating personnel are not suitably qualified,
- ▶ Any type of modification has been made (e.g. exchanging components on the PCB boards, soldering work etc.).

Disposal

- ▶ In safety-related applications, please comply with the mission time T_M stated in the safety-related characteristic data.
- ▶ When decommissioning, please comply with local regulations regarding the disposal of electronic devices (e.g. Electrical and Electronic Equipment Act).

For your safety

The unit meets all the necessary conditions for safe operation. However, please note the following:

- ▶ Note for overvoltage category III: If voltages higher than low voltage (>50 VAC or >120 VDC) are present on the unit, connected control elements and sensors must have a rated insulation voltage of at least 250 V.

Unit features

- ▶ Positive-guided relay outputs:
 - 3 safety contacts (N/O), instantaneous
 - 1 auxiliary contact (N/C), instantaneous
- ▶ Connection options for:
 - E-STOP pushbuttons
 - Safety gate limit switches
 - Start button
 - Light guards and safety switches
- ▶ LED display for:
 - Supply voltage
 - Switch status of the safety contacts
- ▶ Plug-in connection terminals (either spring-loaded terminal or screw terminal)
- ▶ See order reference for unit types

Safety features

The safety relay meets the following safety requirements:

- ▶ The circuit is redundant with built-in self-monitoring.
- ▶ The safety function remains effective in the case of a component failure.
- ▶ The correct opening and closing of the safety function relays is tested automatically in each on-off cycle.

Block diagram/terminal configuration

Type: 24 VAC/DC

► U_B: 24 VAC/DC; Product ID 777301, 787301

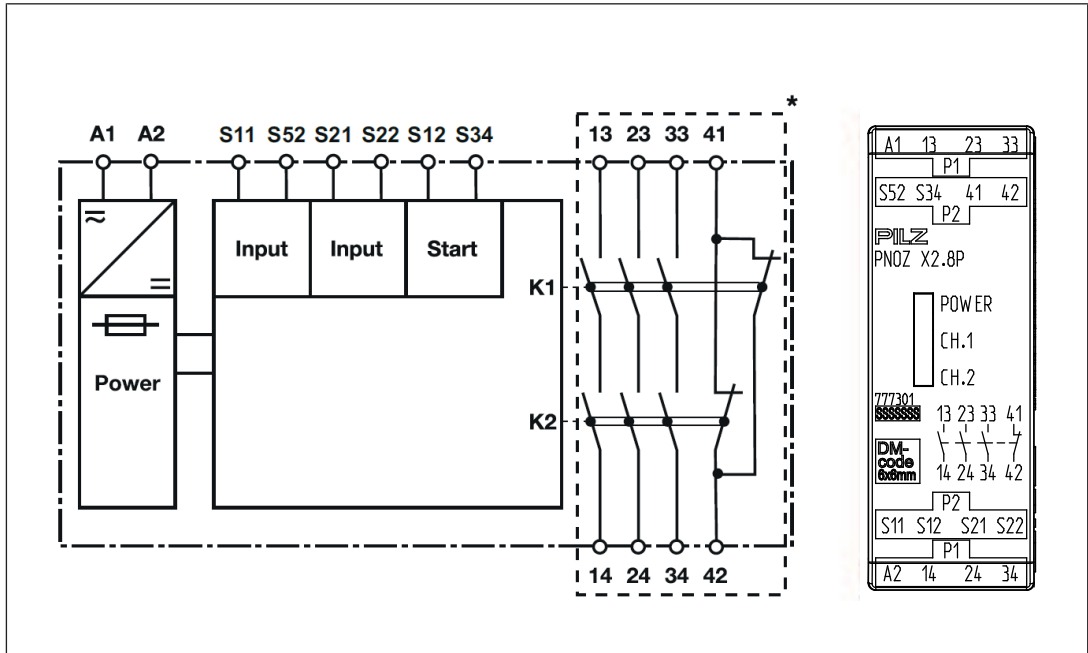

*Insulation between the non-marked area and the relay contacts: Basic insulation (over-voltage category III), Protective separation (overvoltage category II)

Type: 24 - 240 V AC/DC

► U_B: 24 – 240 VAC/DC; Product ID 777302, 787302

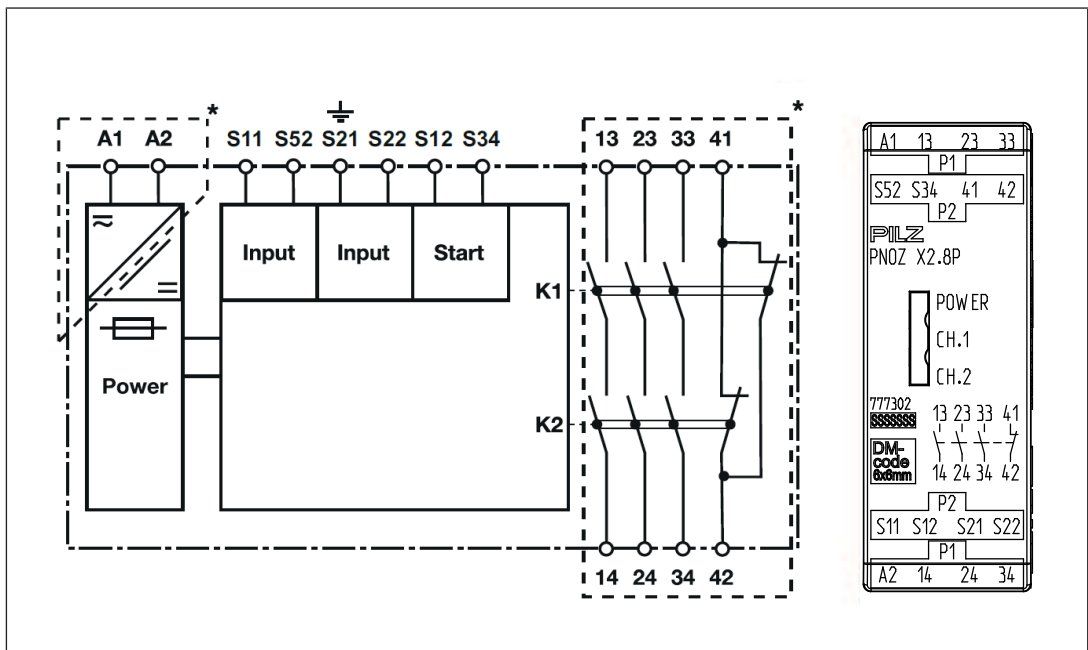

*Insulation between the non-marked area and the relay contacts: Basic insulation (over-voltage category III), Protective separation (overvoltage category II)

Function Description

The safety relay PPNOZ X2.8P provides a safety-oriented interruption of a safety circuit. When supply voltage is supplied the "POWER" LED is lit. The unit is ready for operation when the start circuit S12-S34 is closed.

- ▶ Input circuit is closed (e.g. E-STOP pushbutton not operated):
 - LEDs "CH1" and "CH2" will light.
 - Safety contacts 13-14, 23-24 and 33-34 are closed, auxiliary contact 41-42 is open. The unit is active.
- ▶ Input circuit is opened (e.g. E-STOP pushbutton operated):
 - The LEDs "CH1" and "CH2" go out.
 - Safety contacts 13-14, 23-24 and 33-34 are opened redundantly, auxiliary contact 41-42 is closed.

Operating modes

- ▶ Single-channel operation: No redundancy in the input circuit, earth faults in the start and input circuit are detected.
- ▶ Dual-channel operation without detection of shorts across contacts: Redundant input circuit, detects PNOZ X2.8P
 - earth faults in the start and input circuit,
 - short circuits in the input circuit.
- ▶ Dual-channel operation with detection of shorts across contacts: Redundant input circuit, PNOZ X2.8P detects
 - earth faults in the start and input circuit,
 - short circuits in the input circuit,
 - shorts across contacts in the input circuit.
- ▶ Automatic start: Unit is active once the input circuit has been closed.
- ▶ Manual start: Unit is active once the input circuit and the start circuit are closed.
- ▶ Increase in the number of available contacts by connecting contact expansion modules or external contactors/relays.



NOTICE

The device does not recognise short circuits or shorts across contacts in the start/feedback loop. Take suitable measures, such as fault exclusion through protected or separate installation.

Timing diagram

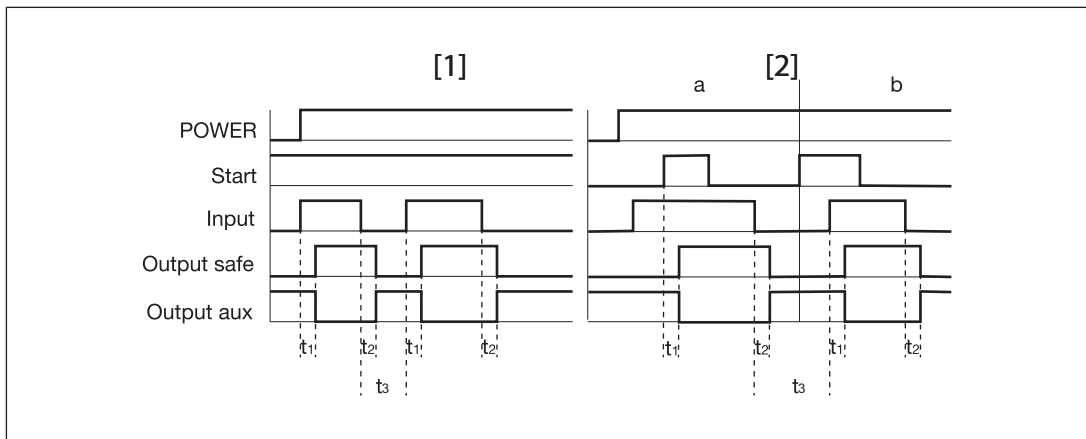

Legend

- ▶ Power: Supply voltage
- ▶ Start: Start circuit
- ▶ Input: Input circuit
- ▶ Output safe: Safety contacts
- ▶ Output aux: Auxiliary contact
- ▶ [1]: Automatic start
- ▶ [2]: Manual start
- ▶ a: Input circuit closes before start circuit
- ▶ b: Start circuit closes before input circuit
- ▶ t_1 : Switch-on delay
- ▶ t_2 : Delay-on de-energisation
- ▶ t_3 : Recovery time

Installation



NOTICE

Protection against manipulation

Protect the product from unauthorised access.

- ▶ The unit should be installed in a control cabinet with a protection type of at least IP54.
- ▶ Use the notch on the rear of the unit to attach it to a DIN rail (35 mm).
- ▶ When installed vertically: secure the unit by using a fixing element (e.g. retaining bracket or end angle).

Wiring

Please note:

- ▶ Information given in the "[Technical details \[17\]](#)" must be followed.
- ▶ Outputs 13-14, 23-24, 33-34 are safety contacts; output 41-42 is an auxiliary contact (e.g. for display).
- ▶ Auxiliary contact 41-42 should **not** be used for safety circuits!
- ▶ To prevent contact welding, a fuse should be connected before the output contacts (see [Technical details \[17\]](#)).
- ▶ Calculation of the max. cable length l_{\max} in the input circuit:

$$l_{\max} = \frac{R_{l_{\max}}}{R_l / \text{km}}$$

$R_{l_{\max}}$ = max. overall cable resistance (see [Technical details \[17\]](#))

R_l / km = cable resistance/km

- ▶ Use copper wiring with a temperature stability of 60/75 °C.
- ▶ To prevent EMC interferences (particularly common-mode interferences) the measures described in EN 60204-1 must be executed. This includes the separate routing of cables of the control circuits (input, start and feedback loop) from other cables for energy transmission or the shielding of cables, for example.
- ▶ Adequate protection circuit must be provided on all output contacts with capacitive and inductive loads.
- ▶ Do not switch low currents using contacts that have been used previously with high currents.
- ▶ When connecting magnetically operated, reed proximity switches, ensure that the max. peak inrush current (on the input circuit) does not overload the proximity switch.
- ▶ With 24 V AC/DC units:
The power supply must meet the regulations for extra low voltages with protective electrical separation (SELV, PELV).

Important for detection of shorts across contacts:

As this function for detecting shorts across contacts is not failsafe, it is tested by Pilz during the final control check. If there is a danger of exceeding the cable runs, we recommend the following test after the installation of the device:

1. Unit ready for operation (output contacts closed)
2. Short circuit the test terminals S12, S22 for detecting shorts across the inputs.
3. The unit's fuse must be triggered and the output contacts must open. Cable lengths in the scale of the maximum length can delay the fuse triggering for up to 2 minutes.
4. Reset the fuse: remove the short circuit and switch off the supply voltage for approx. 1 minute.

Preparing for operation

Supply voltage	AC	DC
$U_B = 24 \text{ VAC/DC}$; Product ID 777301, 787301		
$U_B = 24 - 240 \text{ VAC/DC}$; Product ID 777302, 787302		

Input circuit	Single-channel	Dual-channel
E-STOP without detection of shorts across contacts		
E-STOP with detection of shorts across contacts		
Safety gate without detection of shorts across contacts		
Safety gate with detection of shorts across contacts		
Light curtain or safety switch, de-tection of shorts across contacts via ESPE (only when $U_B = 24 \text{ VDC}$; Product ID 777301, 787301)		



NOTICE

With single-channel wiring, the safety level of your plant/machine may be lower than the safety level of the unit (see [Safety characteristic data \[26\]](#)). To achieve the stated safety level, appropriate measures must be taken on single-channel applications to exclude faults in the input circuit. Examples of such measures are: protected cable routing and positive-opening contacts in the E-STOP pushbutton.



NOTICE

Operation with a light curtain or safety switch

It must not be possible to switch off the supply voltage for the PNOZ X2.8P and the supply voltage for the light curtain or safety switch separately from each other.

Start circuit	E-STOP wiring, safety gate (single-channel)	E-STOP wiring, safety gate (dual-channel)
Automatic start		
Manual start		





NOTICE

In the event of an automatic start or manual start with bridged start contact (fault):

The device starts up automatically when the safeguard is reset, e.g. when the E-STOP pushbutton is released. Use external circuit measures to prevent an unexpected restart.

Feedback loop	Automatic start	Manual start
Contacts from external contactors		

Legend

- ▶ S1/S2: E-STOP/safety gate switch
- ▶ S3: Reset button
- ▶ : Switch operated
- ▶ : Gate open
- ▶ : Gate closed

Operation

When the relay outputs are switched on, the mechanical contact on the relay cannot be tested automatically. Depending on the operational environment, measures to detect the non-opening of switching elements may be required under some circumstances.

When the product is used in accordance with the European Machinery Regulation, a check must be carried out to ensure that the safety contacts on the relay outputs open correctly. Open the safety contacts (switch off output) and start the device again, so that the internal diagnostics can check that the safety contacts open correctly

- ▶ For SIL 3/PL e, at least 1x per month
- ▶ For SIL 2/PL d, at least 1x per year

**NOTICE**

The safety functions should be checked after initial commissioning and each time the plant/machine is changed. The safety functions may only be checked by qualified personnel.

Status indicators

LEDs indicate the status and errors during operation:

-  LED on

-  **POWER**
 Supply voltage is present.

-  **CH.1**
 Safety contacts of channel 1 are closed.

-  **CH.2**
 Safety contacts of channel 2 are closed.

Faults – Interference

- ▶ Earth fault: The supply voltage fails and the safety contacts open. Once the cause of the respective fault has been rectified and the supply voltage is switched off for approx. 1 minute, the unit is ready for operation again.
- ▶ Contact malfunctions: If the contacts have welded, reactivation will not be possible after the input circuit has opened.
- ▶ LED "POWER" does not light: Short circuit or no supply voltage.

Dimensions in mm

* with spring-loaded terminals

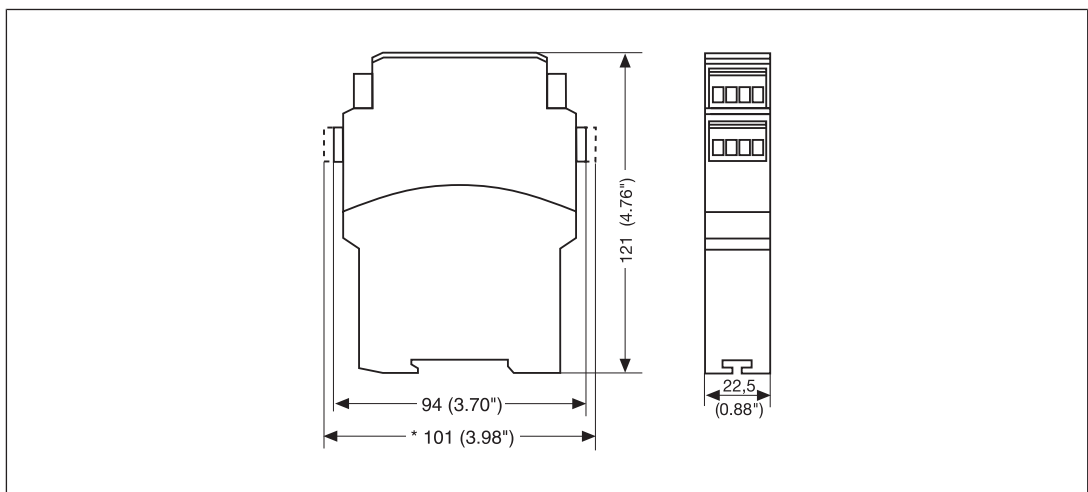

Technical details, Product ID 777301, 777302

Where standards are undated, the 2022-09 valid editions apply.

General	777301	777302
Certifications	CCC, CE, EAC, KOSHA, TÜV, UKCA, cULus Listed	CCC, CE, EAC, KOSHA, TÜV, UKCA, cULus Listed
Electrical data	777301	777302
Supply voltage		
Voltage	24 V	24 - 240 V
Kind	AC/DC	AC/DC
Voltage tolerance	-15 %/+10 %	-15 %/+10 %
Output of external power supply (AC)	5,5 VA	4,5 VA
Output of external power supply (DC)	2,5 W	2 W
Frequency range AC	50 - 60 Hz	50 - 60 Hz
Residual ripple DC	160 %	160 %
Duty cycle	100 %	100 %
Max. inrush current impulse		
Current pulse, A1	1,7 A	–
Pulse duration, A1	3,3 ms	–
Inputs	777301	777302
Quantity	2	2
Voltage at		
Input circuit DC	24 V	24 V
Start circuit DC	24 V	24 V
Feedback loop DC	24 V	24 V
Current at		
Input circuit DC	30 mA	25 mA
Start circuit DC	40 mA	50 mA
Feedback loop DC	40 mA	50 mA
Min. input resistance at power-on	88 Ohm	209 Ohm
Max. overall cable resistance R _{I-max}		
Single-channel at UB DC	30 Ohm	45 Ohm
Single-channel at UB AC	100 Ohm	45 Ohm
Dual-channel without detection of shorts across contacts at UB DC	50 Ohm	80 Ohm
Dual-channel without detection of shorts across contacts at UB AC	100 Ohm	80 Ohm
Dual-channel with detection of shorts across contacts at UB DC	15 Ohm	15 Ohm
Dual-channel with detection of shorts across contacts at UB AC	15 Ohm	15 Ohm

Relay outputs	777301	777302
Number of output contacts		
Safety contacts (N/O), instantaneous	3	3
Auxiliary contacts (N/C)	1	1
Max. short circuit current IK	1 kA	1 kA
Utilisation category		
in accordance with the standard	EN 60947-4-1	EN 60947-4-1
Utilisation category of safety contacts		
AC1 at	240 V	240 V
Min. current	0,01 A	0,01 A
Max. current	6 A	6 A
Max. power	1.500 VA	1.500 VA
DC1 at	24 V	24 V
Min. current	0,01 A	0,01 A
Max. current	6 A	6 A
Max. power	150 W	150 W
Utilisation category of auxiliary contacts		
AC1 at	240 V	240 V
Min. current	0,01 A	0,01 A
Max. current	6 A	6 A
Max. power	1500 VA	1500 VA
DC1 at	24 V	24 V
Min. current	0,01 A	0,01 A
Max. current	6 A	6 A
Max. power	150 W	150 W
Utilisation category		
in accordance with the standard	EN 60947-5-1	EN 60947-5-1
Utilisation category of safety contacts		
AC15 at	230 V	230 V
Max. current	5 A	3 A
DC13 (6 cycles/min) at	24 V	24 V
Max. current	5 A	4 A
Utilisation category of auxiliary contacts		
AC15 at	230 V	230 V
Max. current	5 A	3 A
DC13 (6 cycles/min) at	24 V	24 V
Max. current	5 A	4 A

Relay outputs	777301	777302
Utilisation category in accordance with UL		
Voltage with current	240 V AC G.U. (same polarity) 6 A	250 V AC G.U. (same polarity) 6 A
Voltage with current	24 V DC G. P. 6 A	24 V DC G. P. 6 A
Pilot Duty	R300	B300, R300
External contact fuse protection, safety contacts		
in accordance with the standard	EN 60947-5-1	EN 60947-5-1
Max. melting integral	260 A²s	66 A²s
Blow-out fuse, quick	10 A	6 A
Blow-out fuse, slow	6 A	4 A
Blow-out fuse, gG	6 A	6 A
Circuit breaker 24V AC/DC, characteristic B/C	6 A	4 A
External contact fuse protection, auxiliary contacts		
Max. melting integral	160 A²s	66 A²s
Blow-out fuse, quick	10 A	6 A
Blow-out fuse, slow	6 A	4 A
Blow-out fuse, gG	6 A	6 A
Circuit breaker, 24 V AC/DC, characteristic B/C	6 A	4 A
Contact material	AgCuNi + 0,2 µm Au	AgCuNi + 0,2 µm Au
Conventional thermal current while loading several contacts	777301	777302
I _{th} per contact at UB AC; AC1: 240 V, DC1: 24 V		
Conv. therm. current with 1 contact	6 A	6 A
Conv. therm. current with 2 contacts	4 A	6 A
Conv. therm. current with 3 contacts	3,5 A	4,5 A
I _{th} per contact at UB DC; AC1: 240 V, DC1: 24 V		
Conv. therm. current with 1 contact	6 A	6 A
Conv. therm. current with 2 contacts	6 A	6 A
Conv. therm. current with 3 contacts	5 A	4,5 A

Times	777301	777302
Switch-on delay		
with automatic start typ.	250 ms	350 ms
with automatic start max.	450 ms	500 ms
with automatic start after power on typ.	250 ms	650 ms
with automatic start after power on max.	450 ms	800 ms
with manual start typ.	125 ms	130 ms
with manual start max.	450 ms	500 ms
Delay-on de-energisation		
with E-STOP typ.	15 ms	10 ms
with E-STOP max.	30 ms	20 ms
with power failure typ.	60 ms	–
with power failure max.	100 ms	–
with power failure typ. UB 240 V	–	1200 ms
with power failure max. UB 240 V	–	1800 ms
with power failure typ. UB 24 V	–	180 ms
with power failure max. UB 24 V	–	230 ms
Recovery time at max. switching frequency 1/s		
after E-STOP	50 ms	50 ms
after power failure	200 ms	1800 ms
Supply interruption before de-energisation		
	20 ms	20 ms
Simultaneity, channel 1 and 2 max.		
	∞	∞
Environmental data	777301	777302
Climatic suitability		
Ambient temperature		
Temperature range	-35 - 55 °C	-10 - 55 °C
Storage temperature		
Temperature range	-40 - 85 °C	-40 - 85 °C
Climatic suitability		
Humidity	93 % r. h. at 40 °C	93 % r. h. at 40 °C
Condensation during operation		
	Not permitted	Not permitted
EMC		
	EN 60947-5-1, EN 61000-6-2, EN 61000-6-4, EN 61326-3-1	EN 60947-5-1, EN 61000-6-2, EN 61000-6-4, EN 61326-3-1
Vibration		
in accordance with the standard	EN 60068-2-6	EN 60068-2-6
Frequency	10 - 55 Hz	10 - 55 Hz
Amplitude	0,35 mm	0,35 mm
Airgap creepage		
in accordance with the standard	EN 60947-1	EN 60947-1
Overvoltage category	III / II	III / II
Pollution degree	2	2
Rated insulation voltage		
	250 V	250 V

Environmental data	777301	777302
Rated impulse withstand voltage	4 kV	4 kV
Protection type		
Housing	IP40	IP40
Terminals	IP20	IP20
Mounting area (e.g. control cabinet)	IP54	IP54
Mechanical data	777301	777302
Mounting position	Any	Any
Mechanical life	10,000,000 cycles	10,000,000 cycles
Material		
Bottom	PPO UL 94 V1	PPO UL 94 V1
Front	ABS UL 94 V0	ABS UL 94 V0
Top	PPO UL 94 V1	PPO UL 94 V1
Connection type	Screw terminal	Screw terminal
Mounting type	plug-in	plug-in
Conductor cross section with screw terminals		
1 core flexible	0,25 - 2,5 mm², 24 - 12 AWG	0,25 - 2,5 mm², 24 - 12 AWG
2 core with the same cross section, flexible with crimp connectors, no plastic sleeve	0,25 - 1 mm², 24 - 16 AWG	0,25 - 1 mm², 24 - 16 AWG
2 core with the same cross section, flexible without crimp connectors or with TWIN crimp connectors	0,2 - 1,5 mm², 24 - 16 AWG	0,2 - 1,5 mm², 24 - 16 AWG
Torque setting with screw terminals	0,5 Nm	0,5 Nm
Stripping length with screw terminals	7 mm	7 mm
Dimensions		
Height	94 mm	94 mm
Width	22,5 mm	22,5 mm
Depth	121 mm	121 mm
Weight	185 g	200 g

Technical details, Product ID 787301, 787302

General	787301	787302
Certifications	CCC, CE, EAC, KOSHA, TÜV, UKCA, cULus Listed	CCC, CE, EAC, KOSHA, TÜV, UKCA, cULus Listed
Electrical data	787301	787302
Supply voltage		
Voltage	24 V	24 - 240 V
Kind	AC/DC	AC/DC
Voltage tolerance	-15 %/+10 %	-15 %/+10 %
Output of external power supply (AC)	5,5 VA	4,5 VA
Output of external power supply (DC)	2,5 W	2 W
Frequency range AC	50 - 60 Hz	50 - 60 Hz
Residual ripple DC	160 %	160 %
Duty cycle	100 %	100 %
Max. inrush current impulse		
Current pulse, A1	1,7 A	–
Pulse duration, A1	3,3 ms	–
Inputs	787301	787302
Quantity	2	2
Voltage at		
Input circuit DC	24 V	24 V
Start circuit DC	24 V	24 V
Feedback loop DC	24 V	24 V
Current at		
Input circuit DC	30 mA	25 mA
Start circuit DC	40 mA	50 mA
Feedback loop DC	40 mA	50 mA
Min. input resistance at power-on	88 Ohm	209 Ohm
Max. overall cable resistance RI-max		
Single-channel at UB DC	30 Ohm	45 Ohm
Single-channel at UB AC	100 Ohm	45 Ohm
Dual-channel without detection of shorts across contacts at UB DC	50 Ohm	80 Ohm
Dual-channel without detection of shorts across contacts at UB AC	100 Ohm	80 Ohm
Dual-channel with detection of shorts across contacts at UB DC	15 Ohm	15 Ohm
Dual-channel with detection of shorts across contacts at UB AC	15 Ohm	15 Ohm

Relay outputs	787301	787302
Number of output contacts		
Safety contacts (N/O), instantaneous	3	3
Auxiliary contacts (N/C)	1	1
Max. short circuit current IK	1 kA	1 kA
Utilisation category		
in accordance with the standard	EN 60947-4-1	EN 60947-4-1
Utilisation category of safety contacts		
AC1 at	240 V	240 V
Min. current	0,01 A	0,01 A
Max. current	6 A	6 A
Max. power	1.500 VA	1.500 VA
DC1 at	24 V	24 V
Min. current	0,01 A	0,01 A
Max. current	6 A	6 A
Max. power	150 W	150 W
Utilisation category of auxiliary contacts		
AC1 at	240 V	240 V
Min. current	0,01 A	0,01 A
Max. current	6 A	6 A
Max. power	1500 VA	1500 VA
DC1 at	24 V	24 V
Min. current	0,01 A	0,01 A
Max. current	6 A	6 A
Max. power	150 W	150 W
Utilisation category		
in accordance with the standard	EN 60947-5-1	EN 60947-5-1
Utilisation category of safety contacts		
AC15 at	230 V	230 V
Max. current	5 A	3 A
DC13 (6 cycles/min) at	24 V	24 V
Max. current	5 A	4 A
Utilisation category of auxiliary contacts		
AC15 at	230 V	230 V
Max. current	5 A	3 A
DC13 (6 cycles/min) at	24 V	24 V
Max. current	5 A	4 A

Relay outputs	787301	787302
Utilisation category in accordance with UL		
Voltage with current	240 V AC G.U. (same polarity) 6 A	250 V AC G.U. (same polarity) 6 A
Voltage with current	24 V DC G. P. 6 A	24 V DC G. P. 6 A
Pilot Duty	R300	B300, R300
External contact fuse protection, safety contacts		
in accordance with the standard	EN 60947-5-1	EN 60947-5-1
Max. melting integral	260 A²s	66 A²s
Blow-out fuse, quick	10 A	6 A
Blow-out fuse, slow	6 A	4 A
Blow-out fuse, gG	6 A	6 A
Circuit breaker 24V AC/DC, characteristic B/C	6 A	4 A
External contact fuse protection, auxiliary contacts		
Max. melting integral	160 A²s	66 A²s
Blow-out fuse, quick	10 A	6 A
Blow-out fuse, slow	6 A	4 A
Blow-out fuse, gG	6 A	6 A
Circuit breaker, 24 V AC/DC, characteristic B/C	6 A	4 A
Contact material	AgCuNi + 0,2 µm Au	AgCuNi + 0,2 µm Au
Conventional thermal current while loading several contacts	787301	787302
I _{th} per contact at UB AC; AC1: 240 V, DC1: 24 V		
Conv. therm. current with 1 contact	6 A	6 A
Conv. therm. current with 2 contacts	4 A	6 A
Conv. therm. current with 3 contacts	3,5 A	4,5 A
I _{th} per contact at UB DC; AC1: 240 V, DC1: 24 V		
Conv. therm. current with 1 contact	6 A	6 A
Conv. therm. current with 2 contacts	6 A	6 A
Conv. therm. current with 3 contacts	5 A	4,5 A

Times	787301	787302
Switch-on delay		
with automatic start typ.	250 ms	350 ms
with automatic start max.	450 ms	500 ms
with automatic start after power on typ.	250 ms	650 ms
with automatic start after power on max.	450 ms	800 ms
with manual start typ.	125 ms	130 ms
with manual start max.	450 ms	500 ms
Delay-on de-energisation		
with E-STOP typ.	15 ms	10 ms
with E-STOP max.	30 ms	20 ms
with power failure typ.	60 ms	–
with power failure max.	100 ms	–
with power failure typ. UB 240 V	–	1200 ms
with power failure max. UB 240 V	–	1800 ms
with power failure typ. UB 24 V	–	180 ms
with power failure max. UB 24 V	–	230 ms
Recovery time at max. switching frequency 1/s		
after E-STOP	50 ms	50 ms
after power failure	200 ms	1800 ms
Supply interruption before de-energisation		
	20 ms	20 ms
Simultaneity, channel 1 and 2 max.		
	∞	∞
Environmental data		
Climatic suitability		
	EN 60068-2-78	EN 60068-2-78
Ambient temperature		
Temperature range	-35 - 55 °C	-10 - 55 °C
Storage temperature		
Temperature range	-40 - 85 °C	-40 - 85 °C
Climatic suitability		
Humidity	93 % r. h. at 40 °C	93 % r. h. at 40 °C
Condensation during operation		
	Not permitted	Not permitted
EMC		
	EN 60947-5-1, EN 61000-6-2, EN 61000-6-4, EN 61326-3-1	EN 60947-5-1, EN 61000-6-2, EN 61000-6-4, EN 61326-3-1
Vibration		
in accordance with the standard	EN 60068-2-6	EN 60068-2-6
Frequency	10 - 55 Hz	10 - 55 Hz
Amplitude	0,35 mm	0,35 mm
Airgap creepage		
in accordance with the standard	EN 60947-1	EN 60947-1
Overvoltage category	III / II	III / II
Pollution degree	2	2
Rated insulation voltage		
	250 V	250 V

Environmental data	787301	787302
Rated impulse withstand voltage	4 kV	4 kV
Protection type		
Housing	IP40	IP40
Terminals	IP20	IP20
Mounting area (e.g. control cabinet)	IP54	IP54
Mechanical data	787301	787302
Mounting position	Any	Any
Mechanical life	10,000,000 cycles	10,000,000 cycles
Material		
Bottom	PPO UL 94 V1	PPO UL 94 V1
Front	ABS UL 94 V0	ABS UL 94 V0
Top	PPO UL 94 V1	PPO UL 94 V1
Connection type	Spring-loaded terminal	Spring-loaded terminal
Mounting type	plug-in	plug-in
Conductor cross section with spring-loaded terminals: Flexible with/without crimp connector	0,2 - 1,5 mm ² , 24 - 16 AWG	0,2 - 1,5 mm ² , 24 - 16 AWG
Spring-loaded terminals: Terminal points per connection	2	2
Stripping length with spring-loaded terminals	8 mm	8 mm
Dimensions		
Height	101 mm	101 mm
Width	22,5 mm	22,5 mm
Depth	121 mm	121 mm
Weight	180 g	200 g

Safety characteristic data



NOTICE

You must comply with the safety characteristic data in order to achieve the required safety level for your plant/machine.

Operating mode	EN ISO 13849-1: 2023	EN ISO 13849-1: 2023	EN IEC 62061 SIL CL/max.	EN IEC 61508 PFH [1/h]	EN/IEC 61511 SIL	EN/IEC 61508 PFD	EN ISO 13849-1: 2023 T _M [year]
–	PL e	Cat. 4	SIL 3	2,31E-09	SIL 3	2,03E-06	20

Explanatory notes for the safety-related characteristic data:

- ▶ T_M is the maximum mission time in accordance with EN ISO 13849-1. The value also applies as the retest interval in accordance with EN IEC 61508-6 and EN IEC 61511 and as the proof test interval and mission time in accordance with EN IEC 62061.

All the units used within a safety function must be considered when calculating the safety characteristic data.



INFORMATION

A safety function's SIL/PL values are **not** identical to the SIL/PL values of the products used and may differ from these.

Supplementary data



CAUTION!

It is essential to consider the relay's service life graphs. The relay outputs' safety-related characteristic data is only valid if the values in the service life graphs are met.

The PFH value depends on the switch frequency and the load of the relay output. If the service life graphs are not accessible, the stated PFH value can be used irrespective of the switch frequency and the load, as the PFH value already considers the relay's B10d value as well as the failure rates of the other components.

Service life graph

The service life graphs indicate the number of cycles from which failures due to wear must be expected. The wear is mainly caused by the electrical load; the mechanical load is negligible.

Unit types with UB 24 VAC/DC

- ▶ U_B: 24 VAC/DC; Product ID 777301, 787301

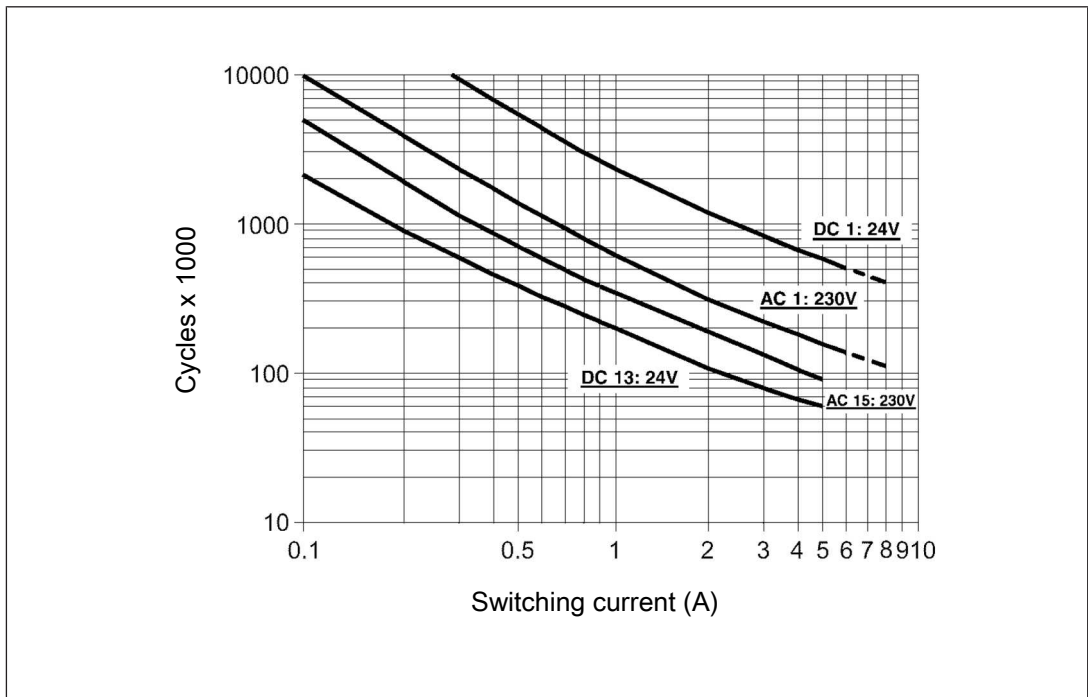

Fig.: Service life graphs at 24 VDC and 230 VAC

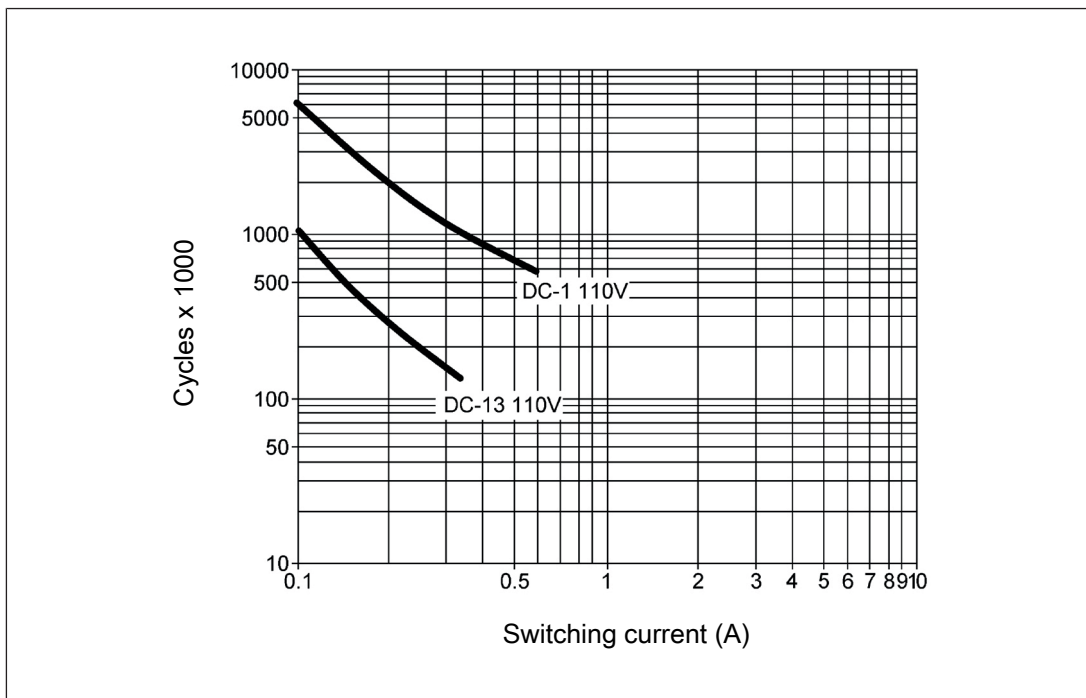

Fig.: Service life graphs at 110 VDC

Example

- ▶ Inductive load: 0.2 A
- ▶ Utilisation category: AC15
- ▶ Contact service life: 2 000 000 cycles

Provided the application to be implemented requires fewer than 2 000 000 cycles, the PFH value (see [Technical details \[17\]](#)) can be used in the calculation.

To increase the service life, sufficient spark suppression must be provided on all output contacts. With capacitive loads, any power surges that occur must be noted. With DC contactors, use flywheel diodes for spark suppression.

Unit types with UB 24-240 VAC/DC

► U_B : 24 – 240 VAC/DC; Product ID 777302, 787302

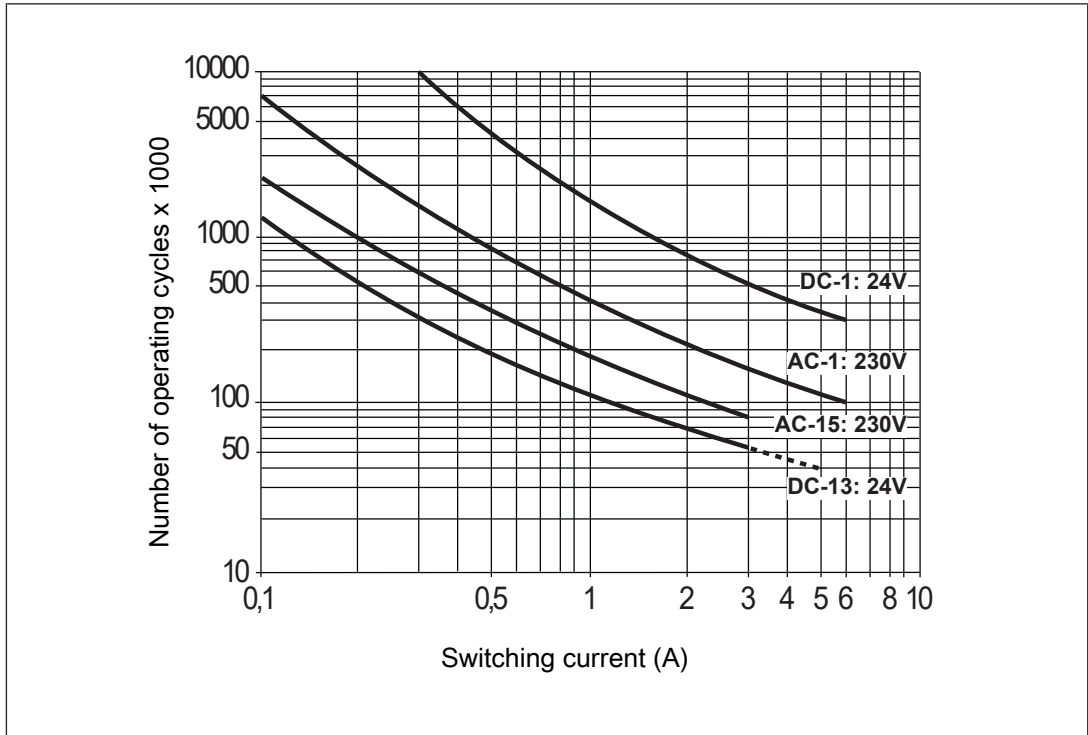

Fig.: Service life graphs at 24 VDC and 230 VAC

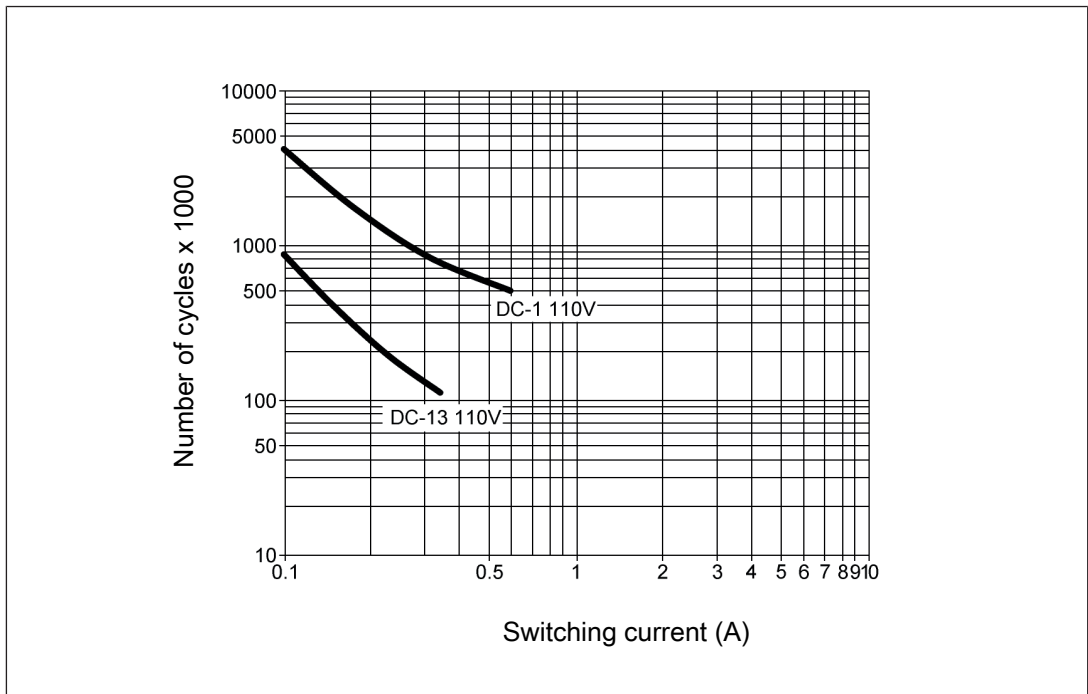

Fig.: Service life graphs at 110 VDC

Example

- ▶ Inductive load: 0.2 A
- ▶ Utilisation category: AC15
- ▶ Contact service life: 1 000 000 cycles

Provided the application to be implemented requires fewer than 1 000 000 cycles, the PFH value (see [Technical details \[17\]](#)) can be used in the calculation.

To increase the service life, sufficient spark suppression must be provided on all relay contacts. With capacitive loads, any power surges that occur must be noted. With DC contactors, use flywheel diodes for spark suppression.

Remove plug-in terminals**Procedure**

- ▶ Insert a suitable screwdriver into the housing recess behind the terminal.

Do **not** remove the terminals by pulling the cables!

- ▶ Lever the terminal out.

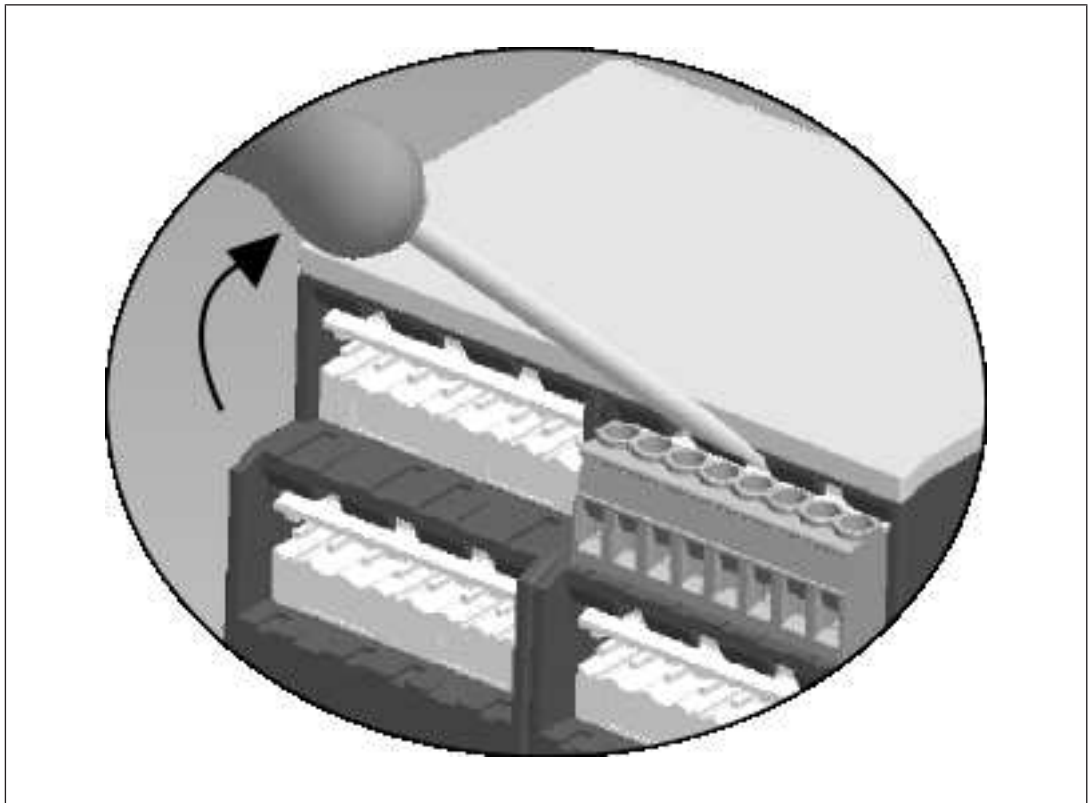

Order reference

Product type	Features	Connection type	Product ID
PNOZ X2.8P	24 VAC/DC:	Screw terminals	777301
PNOZ X2.8P C	24 VAC/DC:	Spring-loaded terminals	787301
PNOZ X2.8P	24 - 240 V AC/DC	Screw terminals	777302
PNOZ X2.8P C	24 - 240 V AC/DC	Spring-loaded terminals	787302

EU/EC declaration of conformity

These products meet the requirements of the directive 2006/42/EC on machinery up to and including 19 January 2027, and the EU regulation 2023/1230 of the European Parliament and of the Council from 20 January 2027. The full EU and EC declaration of conformity is available to download at www.pilz.com/manuals.

Authorised representative: Pilz GmbH & Co. KG, Felix-Wankel-Str. 2, 73760 Ostfildern, Germany

UKCA-Declaration of Conformity

These products comply with following UK legislation: Supply of Machinery (Safety) Regulation 2008.

The complete UKCA Declaration of Conformity is available on the Internet at www.pilz.com/manuals.

Representative: Pilz Automation Technology, Pilz House, Little Colliers Field, Corby, Northamptonshire, NN18 8TJ United Kingdom, eMail: mail@pilz.co.uk

